

ISSUE 8.2

FIRE DETECTION

PRODUCT CATALOGUE

a vital part of your world

tyco
Fire Protection Products

CONTENTS

Chapter 1 - Introduction	1.1	Chapter 6 - System Accessories	6.1
		• Batteries, PSU and Chargers	6.1
Chapter 2 - MZX Technology	2.1	• Door Release Equipment	6.3
• Minerva MZX Addressable Control Panels	2.2	• Auxiliary Interface Relays	6.4
• Minerva MX2 Range	2.4	• Fire Resistant Cable	6.5
• Minerva MX4000	2.5		
• Battery & Expansion Boxes	2.6	Chapter 7 - VESDA	7.1
• Minerva MX Repeaters	2.7	• LaserFOCUS Aspirating Smoke Detection	7.1
• MZX4000 Black Box	2.8	• LaserCOMPACT and MX Laser COMPACT	7.2
• Minerva T2000 & T2000 CV Marine Detection Panels	2.9	• LaserPLUS Standard Modular Range	7.3
• Minerva T2000R & T2000R CV Marine Repeaters	2.10	• LaserPLUS Scanners	7.4
• MX Panel Components	2.13	• Remote Displays and Modules	7.5
• DDA Compliant Pager	2.25	• ICAM IAS800 Air Sampling Smoke Detection Systems	7.7
• Generation 6 Fire Detectors	2.28	• VESDA Pipe, Fittings and Test Equipment	7.8
• Beam and Linear Heat Detectors	2.32	• VESDA Eco Gas Detection	7.11
• Detector Bases & Accessories	2.35	• OSID Smoke Detection	7.13
• Detector Ancillaries	2.39		
• Duct Probe Air Sampling	2.40	Chapter 8 - Fire Phones & Disable Refuge	8.1
• MX Addressable Input/Output Modules	2.42		
• MZX Compatible 4 Amp 24VDC Addressable Door Holder PSU	2.48	Chapter 9 - Water Leak Detection	9.1
• MX Ancillary Housings	2.49		
• Callpoints	2.51	Chapter 10 - Special Hazards	10.1
• Sounders & Beacons	2.57	• Special Hazard Flame Detectors	10.3
• Software Tools & Accessories	2.73	• System 800 Fire Detection for Hazardous Areas	10.7
• MZX Interactive Training CD	2.74	• System 620 Fire Detection for Hazardous Areas	10.15
• Programming and Service Tools	2.76	• MZX SensorLaser Plus Fibre Optic Linear Heat Detection System	10.25
• Service & Spares	2.79		
		Chapter 11 - Useful Information	11.1
Chapter 3 - Conventional Systems	3.1	• MKII Sounder Base Application Table	11.1
• Control Panels and Repeater Panels	3.1	• Sounder Tone Tables	11.3
• Extinguishing Panels, Repeaters & Accessories	3.7	• Consultants Guide	11.5
• DDA Compliant Pager	3.9		
• Point Detectors	3.11	Chapter 12 - Index	12.1
• Beam Detectors	3.16		
• Linear Heat Detectors	3.18		
• Detector Bases and Accessories	3.19		
• Duct Probes	3.23		
• Callpoints	3.25		
• Sounders & Beacons	3.32		
• Service & Spares	3.48		
Chapter 4 - Networks & Graphics	4.1		
• Tyco Expert Graphics (TXG)	4.1		
• TLI800EN Network Interface Module & FOM800 Fibre Optic Module	4.4		
• MX Minerva - Bridge	4.7		
Chapter 5 - Detector Test Equipment	5.1		
• Essential Test Equipment	5.1		
• Additional and Alternative Products and Accessories	5.2		
• Product Selector	5.3		
• Flame Detector Test Equipment	5.4		

This page is left intentionally blank

Fire Detection

Welcome to the latest issue of the Tyco Fire Protection Products Fire Detection Catalogue which details products available from our Letchworth U.K. distribution centre. This catalogue is intended to assist all sellers and system designers involved in fire detection from entry level conventional systems to extensive networked addressable systems and special hazard protection.

In line with our ISO 9000 accreditation, only those products that meet the highest quality criteria have been included.

Our goal is to despatch product on the same day as we receive your order. Our warranty and service returns policy is second to none. We recognise that your business is highly dependant on excellence in customer service and to help achieve this we offer extended warranty from many of our suppliers. Full credit is also available on a "No Question - No Fuss" basis for any new in-warranty product returned to the distribution centre.

New Catalogue Layout

With an emphasis on ease of use, the contents of this Issue has been arranged to meet the specific needs of individual users. Each section covers a different aspect of fire detection and contains all product associated with that subject. If a particular product is used for example with both conventional systems and addressable systems, it will appear in both sections. Each section can therefore be used independently and each section can also be downloaded separately from the Tyco Fire Protection Products website. The 12 sections covered are:

1. Introduction
2. Addressable Systems
3. Conventional Systems
4. Networks & Graphics
5. Detector Test Equipment
6. System Accessories
7. Aspirating Systems
8. Fire Phones and Disabled Refuge
9. Water Leak Detection
10. Special Hazards
11. Useful Information
12. Index

Website

The Tyco Fire Protection Products website is full of up-to-date information including a section dedicated to fire detection products where you will find lots of useful information including;

Approval Certificates
AutoCAD Downloads
Catalogues
Datasheets
Forums
Marketing Bulletins
Presentations

Technical Information including;

User manuals
Application & Design Manuals
Installation Manuals
Commissioning Manuals
Service Manuals
Sales Information
Software Downloads

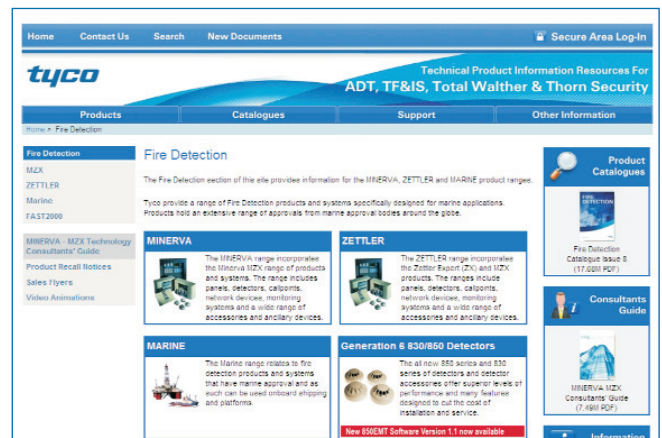

Contact Us

For further details on this catalogue, contact our customer telephone Help Line at Letchworth Customer Services on + 44 (0) 1462 66 77 00.

TFS Technical Support Call Centre:-

Direct: +31 475 352 722

Fax: +31 475 352 725

Hours: 9:00 to 19:00 CET, 8:00 to 18:00 GMT, 7:00 to 17:00 EET

UK only: 08701-238 787

Toll Free: 0800 CALL TYCO or (0800 22 55 89 26)

E-Mail: TSPEuropeSupport@tycoint.com

Our web site can be found at: www.tycoemea.com

This page is left intentionally blank.

MZX Detection Panels

Tyco MX detection panels use all the features of Tyco MX Technology to provide the latest fire detection technology meeting the latest worldwide standards in cost-effective, expandable packages.



Tyco MX detection panels support Tyco MX Technology:

- MX VIRTUAL Multi-sensor detectors
- MX DIGITAL high speed reliable digital protocol
- MX FASTLOGIC fuzzy logic smoke detection algorithms
- MX CCO universal carbon monoxide fire detection algorithms

Tyco MX detection panels provide modular cost effective solutions:

- Networked panels from 1 to 792 detection loops
- Powerful central loop processing functions
- Powerful and modular user interface
- MX REMOTE diagnostics and service functions
- TXG graphical user interfaces
- MZX, MX2 and designer housing options

Tyco MX detection panels provide long term fire detection solutions including upgrade paths from earlier panel models and a long term development strategy providing future upgrade paths.

Tyco MX detection panels include:

- MZX for compact single loop solutions
- MINERVA MX for EN54 LPCB approved systems
- MINERVA T2000 for Marine approved systems

Tyco MX detection panels include a powerful user interface:

- 640 Character display
- Displays first alarm and most recent alarm
- Permanently displays systems status including number of alarms, number of faults, number of isolated points
- Scroll function allows details of all events and status to be easily viewed
- Displays temperature, CO level and smoke level at point in alarm
- Displays 95 character custom messages for emergency procedures

Tyco MX panels include advanced manager and engineer functions including:

- Menu driven
- Multi-level password protected
- Viewing 3000 event log
- Detailed fault reporting
- Isolate by point, zone or sector
- Viewing and printing status
- Viewing and printing isolated points
- Manual and automatic walk test and reporting functions
- Viewing and printing maintenance reports
- Extensive diagnostic functions including simulation and force outputs
- Text and configuration changes/Automatic battery test
- Detector service functions

Tyco MX detection panels include very powerful event/action programming including:

- Seamless network wide event/action
- 240 x 240 Output map and output sequencing algorithms
- Over 3000 event/action groups for the most complex applications
- Templates for fast programming of standard applications including:
 - EN54/BS5839
 - EN54 Marine
- User defined templates
- Time, date and special day programming
- Wide range of co-occurrence, double knock and delay functions



Features

- Supports one, two or 4 loops with 125, 250, 500 or 1000 addresses (panel dependant)
- 2km loop length
- High level User Interface with “Front Panel Controls” to reduce lifetime cost of ownership
- Wide range of detectors including the 3oTec triple sensing detector providing early detection without false alarms.
- Wide range of ancillaries including door control to BS7273 category A
- DDA compliance using AVBase and loop powered sounder beacons.
- Approved to EN54 the system is designed to be installed to BS5839 Part 2

Minerva® MZX Addressable Control Panels

This range of digital addressable fire control panels uses the well established MXDigital® Loop protocol, detectors, i/o modules, user interface and software from the MX range of panels. They provide a single box solution ideally suited for small and medium sized installations up to 240 zones.

The following models are available :-

MZX125 Single Loop, 125 Addresses, 16 Zones
 MZX250 Single Loop, 250 Addresses, 32 Zones
 MZX251 Single Loop, 250 Addresses, 32 Zones
 MZX252 Two Loop, 500 Addresses, 32 Zones
 MZX253 2 to 4 Loop, up to 1000 addresses, 64 Zones
 MZX254 2 to 4 Loop, up to 1000 addresses, 240 Zones
 The MZX125 housing has space for 2 x 12Ah batteries
 The MZX250 housing has space for 2 x 17Ah batteries
 The MZX251, 252, 253 and 254 housings have space for 2 x 38Ah batteries

Running the robust MXDigital® loop protocol the panels can operate using most cable types. This makes them ideal for upgrades as the existing cables can be utilised reducing installation time and cost.

All panels are complete with an integral PSU which will support a full compliment of loop powered sounders and beacons.

The MZX250, 251, 252, 253 and 254 control panels can be fitted with the TLI800EN network interface module, This enables up to 99 control panels to be seamlessly networked, or to be added to an existing network of MX Fire controllers.

Repeaters

Four dedicated repeaters are available. These repeaters offer the user full panel functionality. Up to 7 repeaters can be attached to the control panel's 2 wire remote bus. Two repeaters are mains driven with internal mains psu & batteries and two require an external 24VDC supply.

MZX16R 16 Zones with space for 7Ah or 12Ah batteries
 MZX32R 32 Zones with space for 17Ah batteries
 MZX64DR 64 Zones (requires 24VDC supply)
 MZXDR 240 Zones (No Zonal Led's) (Requires 24VDC supply)



Product Codes

557.200.501	MZX125 1 loop 16 Zone Fire Controller
557.200.502	MZX250 1 loop 32 Zone Fire Controller
557.200.503	MZX251 1 loop 32 Zone Fire Controller
557.200.506	MZX252 2 loop 32 Zone Fire Controller
557.200.508	MZX253 2 to 4 loop 64 Zone Fire Controller
557.200.509	MZX254 2 to 4 loop 240 Zone Fire Controller (No Zonal LED'S)
557.202.073	2 Loop expansion kit for MZX253 (includes XLM loop card)
557.200.520	MZX16R 16 Zone Repeater (mains powered)
557.200.521	MZX32R 32 Zone Repeater (mains powered)
557.200.526	MZX64DR 64 Zone Repeater (24VDC powered)
557.200.523	MZXDR 240 Zone Repeater No Zonal Led's (24VDC powered)
557.201.502	Semi-Flush Bezel for MZX125/MZX16R
557.201.501	Semi-Flush Bezel for MZX250/251/252/253/254/MZX32R
557.201.503	Accessory mounting plate for std modules, IOB800, LIM800 and TUD800 (MZX250/251/252/253/254 only)
557.201.519	Comms Interface mounting plate (MZX250/251/252/253/254 only)
557.201.510	Rack mount kit for MZX 125
557.201.511	Rack mount kit for MZX 250
557.201.512	Rack Mount Kit for MZX 251/252/253/254
557.201.307	MZX250 17Ah Battery Clamp
557.201.505	MZX251/ 252 38Ah Battery Clamp
557.201.520	MZX251/252/253/254 24Ah Battery Clamp

Chapter 2 - MZX Technology

MZX Addressable Control Panels Technical Specifications

	MZX125	MZX250	MZX251/252/253/254	MZX16R	MZX32R	MZX64DR/MZXDR
Dimensions H x W x D mm	370x325x126	480x410x140	480x410x205	370x325x126	480x410x140	370x254x84
Weight	7kg	9.7kg	10.6kg	6.6kg	9.3kg	4kg
Operating Temp	-5°C +40°C					
Storage Temp	-20°C +70°C					
Humidity	90% relative Humidity Non Condensing					
Housing Colour	RAL7035					
Facia Colour	Pantone Grey 431C					
EMC/RFI	EN50130-4 & EN61000-6-3					
Supply Voltage	230VAC 50/60 Hz					24VDC
Input Current	0.9A	1.6A	1.6A	0.9A	0.9A	250mA
Charger Size Note 1	2.5A	5.0A	5.0A	2.5A	2.5A	none
Max Battery Size	2 x 12V 12Ah	2 x 12V 17Ah	2 x 12V 38Ah	2 x 12V 12Ah	2 x 12V 17Ah	none

Note 1 – Max PSE output current with the charger interrupted (I max b, EN54-4)

MZX Ancillary housings & PSUs

This range of housing & PSU's is designed to complement the MZX range of fire controllers, the housings are available in different sizes to match the MZX fire controller. Two ranges of ancillary housing are available; one is designed to accommodate various modules on the removable chassis plate and also has the option to mount a document holder on the rear of the door. The other ancillary housings, (aperture housings) are designed to accommodate one or two standard sized MX control, display, printer or annunciator modules ie ANN880, COM820, PRN800 or similar, a chassis plate for mounting modules is also fitted.

The housings with two apertures are supplied with one blanking plate

Product Codes

557.202.625	ANC125-A	Ancillary Housing, One Aperture (Small - matches MZX125)
557.202.626	ANC250-A	Ancillary Housing, Two Aperture (Large – matches MZX250)
557.202.627	ANC251-A	Ancillary Housing, Two Aperture (Deep – matches MZX251/252/253/254)
557.202.622	ANC125	Ancillary Housing (Small - matches MZX125)
557.202.623	ANC250	Ancillary Housing (Large – matches MZX250)
557.202.624	ANC251	Ancillary Housing (Deep – matches MZX251/252/253/254)
557.201.513		Document Holder attachment (used with ANC125/250/251)
557.201.518		M520 Anc Fitting Kit – req'd for older M520 modules, fittings for 4 modules

Power Supply Units

The power supplies utilise switch mode PSU's as used in the MZX range of panels, if monitoring of these PSU's is required a monitoring kit is available which includes a MIM800, mounting bracket and cables

557.200.530	PSU A17	17Ahr 5A Addressable expansion PSU - matches MZX250
557.200.531	PSU A38	38Ahr 5A Addressable expansion PSU - matches MZX251/252/253/254
557.201.516		PSU monitor kit (includes MIM800)





Minerva MX2 Range - IEC 61508 Approved (SIL2)

The Minerva MX2 range of panels are intelligent LPCB EN54 compliant panels, which can be networked to provide up to 396 detection loops and installed to BS5839:Pt1 2002.

The MX2 design philosophy is to have a single panel housing that incorporates all the necessary components required to satisfy the most comprehensive of specifications. Additional matching ancillary housings can accommodate a range of standard modules, adjacent to or remote from the main controller.

- MX2 panels support two MX DIGITAL detection loops with up to 250 addressable devices per loop.
- MX2 panels can be expanded to eight loops supporting up to 1000 addressable devices.
- MX2 consists of a strong steel enclosure incorporating a removable chassis plate. The chassis plate holds:
- PSU830 5A 24Vdc battery back power supply and loop booster to EN54:pt.4.
- FIM800 field interface PCB incorporating two MX DIGITAL loops.
- CPU800 32 bit processor and memory card
- Optional network card and additional loop card(s)
- Optional IOB800 input/output expansion card

The panel has a removable steel front door, which incorporates the MX user interface and optional zonal LED's. The user interface has a 16 x 40-character backlit LCD display, simple alphanumeric keypad and 5 soft-keys. All mandatory operator controls are provided with LED functions including Day/Night switching. One control key and 2 status indication LEDs are provided for site-specific functions.

Product Codes

557.200.203	MX2-210 Two loop c/w LEDs shallow housing	557.202.206	MX battery expansion aperture installation kit.
557.200.205	MX2-211 Two loop c/w LEDs deep housing	557.202.204	MX2 Battery housing
557.200.207	MX2-XB0 Expansion Box Shallow	557.202.205	MX2 Battery and Expansion Housing (65AH)
557.200.208	MX2-XB1 Expansion Box Deep	557.202.209	MX2 LCD Assembly (Spare)
557.200.209	MX2-FB Panel/repeater flush mounting bezel	557.202.208	MX2 8 Loop Expansion Kit
557.200.210	MX2-FBX Expansion box flush mounting bezel	557.202.200	DCM800 (Display + Control Module)
557.202.007	XLM800 Loop expansion module		
557.202.080	TLI800EN Network Card and Cable		
557.202.021	ANN840 LED Annunciator 40 way bi-colour		
557.202.022	ANN880 LED Annunciator 80 way		
557.202.020	COM820 Status command module 20 way		
557.202.024	PRN800 In-built thermal printer (expansion box)		
557.201.211	Ancillary/expansion board mounting kit		



Features

- Compact
- MX Technology Digital Loop
- LPCB Approved

Minerva MX4000 - IEC 61508 Approved (SIL2)

The MINERVA MX panels are intelligent LPCB EN54 approved panels, which can be networked to provide up to 792 detection loops and installed to BS5839:Pt.1.

- The MX4000 supports two MX DIGITAL detection loops and can be expanded to eight loops supporting up to 1000 addressable devices.
- The MX4000 provides up to 240 zones of detection

Both panels consist of a strong steel enclosure incorporating a removable chassis plate. The chassis plate holds:

- PSB800M 5A 24Vdc battery backed power supply and loop booster to EN54:pt.4
- FIM800 field interface PCB incorporating one or two MX DIGITAL loops
- CPU800 32 bit processor and memory card
- Optional network card and additional loop card(s)
- Optional IOB800 input/output expansion card

The panel has a strong cast aluminium front door, which incorporates a modular user interface that fully complies with EN54:pt.2. The user interface incorporates the ODM800 operator display module with a 16 x 40-character backlit LCD display, simple alphanumeric keypad, 5 softkeys. The OCM800 operator control module provides all mandatory operator control keys and LED functions including Day/Night switching. Two control keys and 2 indication LEDs are provided for site-specific functions. Control keys and LEDs are labelled in English according to the default LPCB functionality. The slide in decals can be reversed and alternative text added.

A maximum of 1200 digital INPUT/OUTPUT points can be provided via expansion boards connected to the remote bus.

Product Codes

Standard Panels

557.200.003	MX4000 Two to Four Loop Panel – Shallow Back Box
557.200.004	MX4000 Two to Eight Loop Panel – Deep Back Box
557.200.009	MX4000 Two to Four Loop Panel - Flush Back Box

Options

557.202.006	IOB800 (8in/8out) expansion board (Max. 24 I/O on main panel 8in/16out)
557.202.007	XML-MX two loop MX DIGITAL expansion card
557.202.080	TLI800EN Network Card and Cable



Features

- Compact
- Low Cost Option
- Rack Mounting Kit

Battery & Expansion Boxes

The batteries and any additional zone LED's or operator controls and fireman's interface are mounted in a separate housing which can be mounted below the main panel or behind the panel. The matching battery and expansion box is available with shallow (17Ah) or deep backbox (38Ah) according to the batteries used.

The chassis plate in the battery box also has space for up to 2 x IOB800 input/output expansion modules (maximum 24 I/O) or 1 x MX FILNET or 1 x PSM/PSB800M.

Product Codes

557.200.005	MX-BBX 17Ah shallow expansion and battery box
557.200.019	MX-BBX-F 17Ah shallow flush expansion and battery box
557.200.006	MX-DPBX 38Ah deep expansion and battery box.
557.200.016	MX-BATT Deep Battery Box (322H x 442W x 217D mm)
572.065	MX Rack Mounting Kit for standard 19" racks



Features

- Fully Functional
- Flush or Surface Mounting
- Fully Monitored

Minerva MX Repeaters

The MINERVA MX full function repeater is an EN54 LPCB approved repeater with optional addressable EN54:Pt.4 power supply. The repeater consists of a steel backbox and cast aluminium front door which incorporates the ODM800 operator display module with a 16 x 40-character backlit LCD display, simple alphanumeric keypad and 5 softkeys. The OCM800 operator control module provides all mandatory operator control keys and LED functions including Day/Night switching. One control key and 2 indication LEDs are provided for site-specific functions.

Control keys and LEDs are labelled in English according to the default LPCB functionality. The slide in decals can be reversed and alternative text added.

Two power supply options are available for repeaters. The MXR incorporates an RSM800 repeater supply module for connection to a 24 Vdc supply. Or the MXR-PSU which incorporates a PSM800 power supply module for connection to a 120-240Vac mains supply and an APM800 addressable power monitor for connection to an MX addressable loop, providing power supply monitoring in accordance with EN54-pt.4.

The back box has a removable chassis plate with either the RSM800 or the PSM800 power supply. APM800 addressable PSU monitor and provides space for 2 x 7 Ah batteries to provide 72 h backup.

The MINERVA MX repeater is connected to the Panel via the remote bus (RS485, 1200 m distance). A maximum of 7 repeaters (including one MX REMOTE repeater) can be linked to each MINERVA MX panel and can provide full repeater functions for all panels on the system.

The operator control module (OCM800) can support up to 80 inputs and outputs in the form of LED annunciators, IOB800 input/output modules, or com 820 command modules.

Product Codes

Standard Repeaters

557.200.012	MXR Repeater with shallow backbox (24Vdc)
557.200.017	MXR-F Repeater with flush backbox (24Vdc)
557.200.013	MXR-PSU Repeater and addressable PSU (120-240 Vac)

Options

557.202.006	IOB-800 (8in/8out) expansion board
557.180.005	Mimic driver module
557.180.016	XIOM universal I/O module
557.202.028	RSM800 PSU Module (24Vdc)



Features

- 2 MZX detection loops as standard
- Expandable to 8 loops using XLM800
- Same loop power capability of standard MZX4000 panel/
Reduces the cost of network systems
- Uses MXNet networks (network card supplied separately)
- Create a system of distributed loops to reduce installation costs
- Alarm, fault, power and system fault status display
- Single deep surface mount enclosure
- Integral power supply and space for 38AH batteries
- Distributed power supplies reduce cabling costs
- On board dual sounder circuits/Printer support at each black box
- Fully featured and supported remote bus at each black box-drive repeaters and mimic displays
- Download MX Consys configurations from any panel or black box on the network

MZX4000 Black Box - IEC 61508 Approved (SIL2)

For situations where a networked MX Technology™ panel is not required to have a user interface an MZX4000 black box panel can be used. Black box panels consist of steel back boxes which house the FIM, processor board, power supply and optional network card and expansion loop card. The front cover is of steel construction and has a simple status display panel giving LED indication of alarm, fault, power and system fault.

MZX4000 black box panels are fully featured MZX Technology™ panels designed to be used on networked systems in situations where a local user interface is not required.

Technical Specification

Dimensions (mm):	640H X 440W X 230D
Aprox weight:	16Kg
Colour, housing & front cover:	Dawn Grey (BS 4800 10A)
Operating Temp:	Range -8°C to +55°C
Storage Temp:	-20°C to +70°C
Relative Humidity:	95% non condensing
Supply voltage:	120 to 240 Vac
Input current:	0.8 to 2.2A

Product Code

542.098 MZX4000 Black Box



Features

- PSU830 5A 24V DC battery backed power supply and loop booster to EN54pt4
- FIM800 field interface PCB incorporating one or two MX DIGITAL loops
- CPU800 32 bit processor and memory card
- Optional network card and additional loop card(s) (T2000 only)
- VDR (Voyage Data Recorder) Interface as standard

Minerva T2000 and T2000 CV Marine Detection Panels IEC 61508 Approved (SIL2)

The T2000 is a fully Marine approved EN54 compliant 1 to 8 loop networkable detection panel. The T2000 supports two Tyco MX DIGITAL detection loops and can be expanded to eight loops supporting up to 1000 addressable devices. The T2000 consists of a strong stainless steel or mild steel Marine approved enclosure incorporating the above features.

The T2000CV is a 3 loop marine approved panel housed in a mild steel enclosure designed for use in commercial vessels.

All panels have a strong cast aluminium front door, which incorporates a modular user interface that fully complies with EN54 pt2. The user interface incorporates the ODM800 operator display module with a 16 x 40-character backlit LCD display, simple alphanumeric keypad and 5 softkeys.

The OCM800 operator control module provides all mandatory operator control keys and LED functions including Day/Night switching. One control key and 2 indication LEDs are provided for vessel specific functions. Control keys and LEDs are labelled in English according to the default Marine functionality. The slide in decals can be reversed and alternative text added.

The batteries and any additional zonal LED's or operator controls are mounted in a separate housing which can be mounted below the main panel or behind the panel. The battery box incorporates a heavy duty backbox and battery clamp.

The chassis plate in the battery box also has space for up to 2 x IOB800 input/output expansion modules (maximum 24 I/O) or 1 x PSU830.



Product Codes

- | | |
|-------------|--|
| 557.200.600 | T2000 Two To Eight Loop Marine Panel (Stainless steel enclosure) |
| 557.200.602 | T2000B Battery Box (Stainless steel enclosure) |
| 557.200.605 | T2000 BM Battery Box (Mild steel enclosure) |
| 557.200.606 | T2000 RMRS Door Stay Kit |
| 557.200.610 | T2000 Standard Two to Eight Loop Marine Panel (Mild steel enclosure) |
| 557.201.216 | T2000 XLM 8-Loop Mounting Kit |
| 557.200.620 | T2000CV 3 loop marine panel (mild steel back box) |
| 557.202.127 | VDR Cable For a Standalone panel, Com port 3 |
| 557.202.128 | VDR Cable for a networked system, Com port 1 |
| 557.180.454 | Marine Bulkhead Mount |
| 557.180.452 | Marine 19" rack mount kit for use with surface mounting housings |
| 557.180.022 | Terminal chamber PCB assembly |
| 557.201.233 | PSU 830 T2000/T2000R Conversion Kit |
| 557.201.234 | PSU 830 T2000 120VAC Kit |
| 508.023.126 | AC2SW 230VAC Changeover Unit |
| 508.023.127 | AC1SW 115VAC Changeover Unit |



Features

- Fully Functional
- Optional Approved Mild Steel Enclosure
- Fully Monitored R-Bus

Minerva T2000R and T2000R CV Marine Repeaters - IEC 61508 Approved (SIL2)

The T2000R full function repeater is an EN54 Marine approved repeater with optional addressable EN54:Pt.4 power supply. The repeater consists of a steel backbox and cast aluminium front door which incorporates the ODM800 operator display module with a 16 x 40-character backlit LCD display, simple alphanumeric keypad and 5 softkeys. The OCM800 operator control module provides all mandatory operator control keys and LED functions including Day/Night switching. One control key and 2 indication LEDs are provided for vessel-specific functions. Control keys and LEDs are labelled in English according to the default Marine functionality. The slide in decals can be reversed and alternative text added. The back box has a removable chassis plate with the PSU830 power supply and space for 2 x 7 Ah batteries to provide 72h backup.

The T2000R CV indicating repeater is an EN54 Marine approved repeater (24Vdc Supply). The repeater consists of a mild steel backbox and cast aluminium front door which

incorporates the ODM800 operator display module with a 16 x 40-character backlit LCD display, simple alphanumeric keypad and 5 softkeys. Operator controls comprise a panel buzzer silence button, status LED's are provided for fire, fault and power on indication.

Both repeaters are connected to the Panel via the remote bus (RS485, 1200 m distance). A maximum of 7 repeaters (including one MX REMOTE repeater) can be linked to each control panel and can provide repeater functions for all panels on the system.

The repeater can support up to 80 inputs and outputs in the form of LED annunciators, IOB800 input/output modules, XIOM universal I/O modules or the 80 LED mimic module.

Product Codes

557.200.601	T2000R Marine Repeater with Power Supply Unit 240Vac (Stainless steel enclosure)
557.200.604	T2000R Marine Repeater without Power Supply Unit 24Vdc (Stainless steel enclosure)
557.200.606	T2000 RMRS Door Stay Kit
557.200.611	T2000R Standard Marine Repeater with Power Supply Unit 240Vac (Mild steel enclosure)
557.200.612	T2000R Standard Marine Repeater without Power Supply Unit 24Vdc (Mild steel enclosure)
557.200.621	T2000R CV Marine Indicating Repeater without Power supply unit 24Vdc (Mild Steel enclosure)
557.201.233	PSU 830 T2000/T2000R Conversion Kit
557.201.234	PSU 830 T2000 120VAC Kit
508.023.126	AC2SW 230VAC Changeover Unit
508.023.127	AC1SW 115VAC Changeover Unit

Chapter 2 - MZX Technology

MX Detection Panels - Technical Specifications & System Schematics

MX Detection Panels - Designer Housing Technical Specification

	Shallow Housing	Flush Shallow Housing	Deep Housing	Marine
Dimensions (mm)	320Hx440Wx120D	380Hx500Wx120D	320Hx440Wx215D	320Hx440Wx135D
Approx Weight	7Kg	7.2Kg	8Kg	14Kg
Temperature (Storage)	-20°C to +70°C	-20°C to +70°C	-20°C to +70°C	-20°C to +70°C
Temperature (Operating)	-8°C to +55°C	-8°C to +55°C	-8°C to +55°C	-8°C to +55°C
Humidity	up to 95% RH, Non-Condensing			
Colour (Housing)	Dawn Grey (BS 4800 10A - 03)			
Colour (Modules)	Pantone 431C			
EMC/RFI	EN 50130-4			
Shock	EN 54-2			
Vibration	EN 54-2			

MX2 Detection Panels Technical Specification

	Panel Shallow Housing	Panel Deep Housing	Expansion Housing Shallow	Expansion Housing Deep
Dimensions (MM)	580H x 458W x 129D	580H x 458W x 209D	357Hx 458W x 129D	357H x 458W x 209D
Approx Weight	12.7kg	15.2kg	6.2kg	7.5kg
Temperate (storage)	-20 °C to + 70°C			
Temperate (operating)	-5°C to +55 °C			
Humidity	Up to 90 % RH Non Condensing			
Colour (Housing)	Dawn Grey (BS4800 10A-03)			
Colour (Modules)	Pantone 431C			
EMC/RFI	EN50130-4 EN61000-6-3			
IP Rating	IP30			

Chapter 2 - MZX Technology

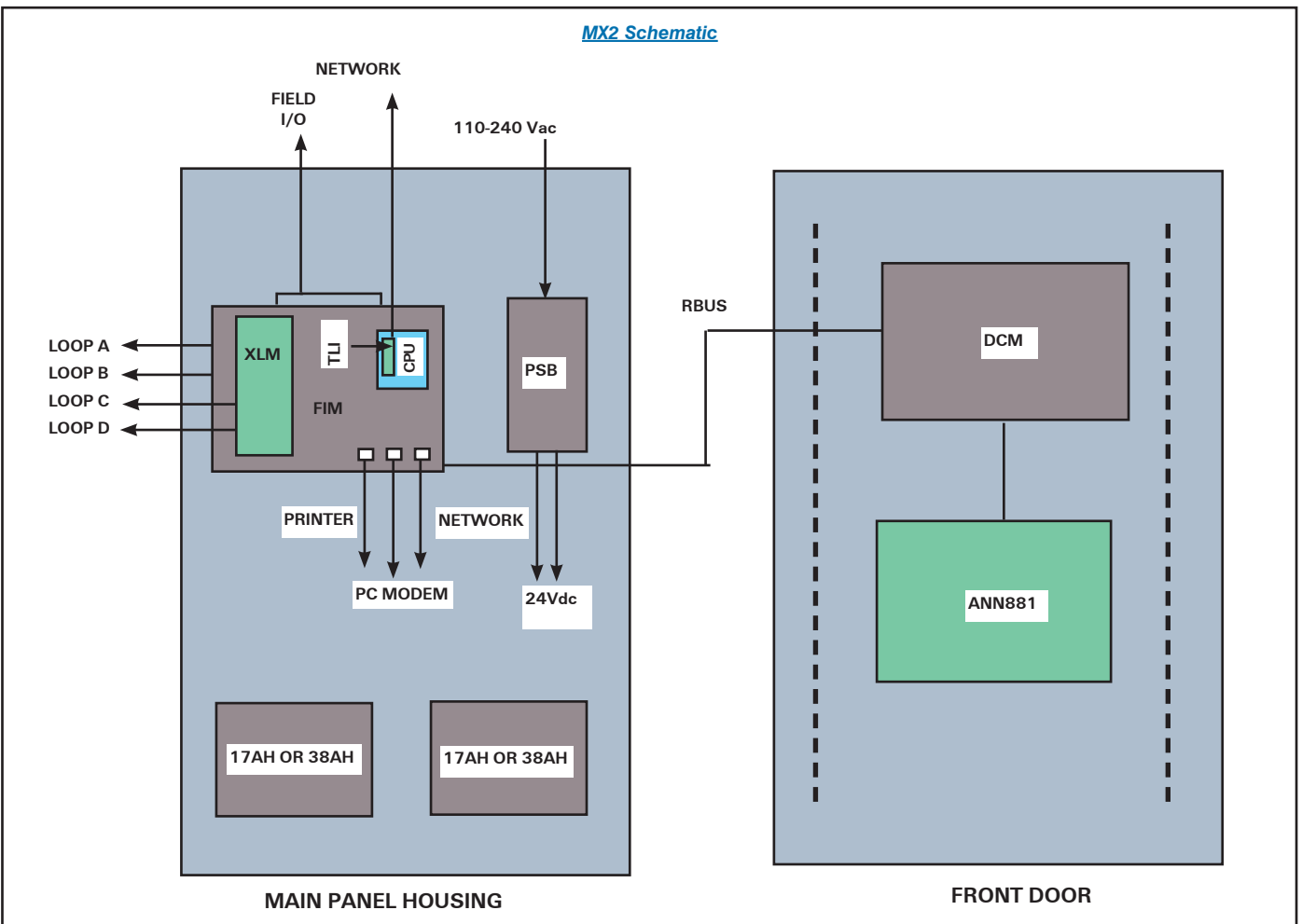
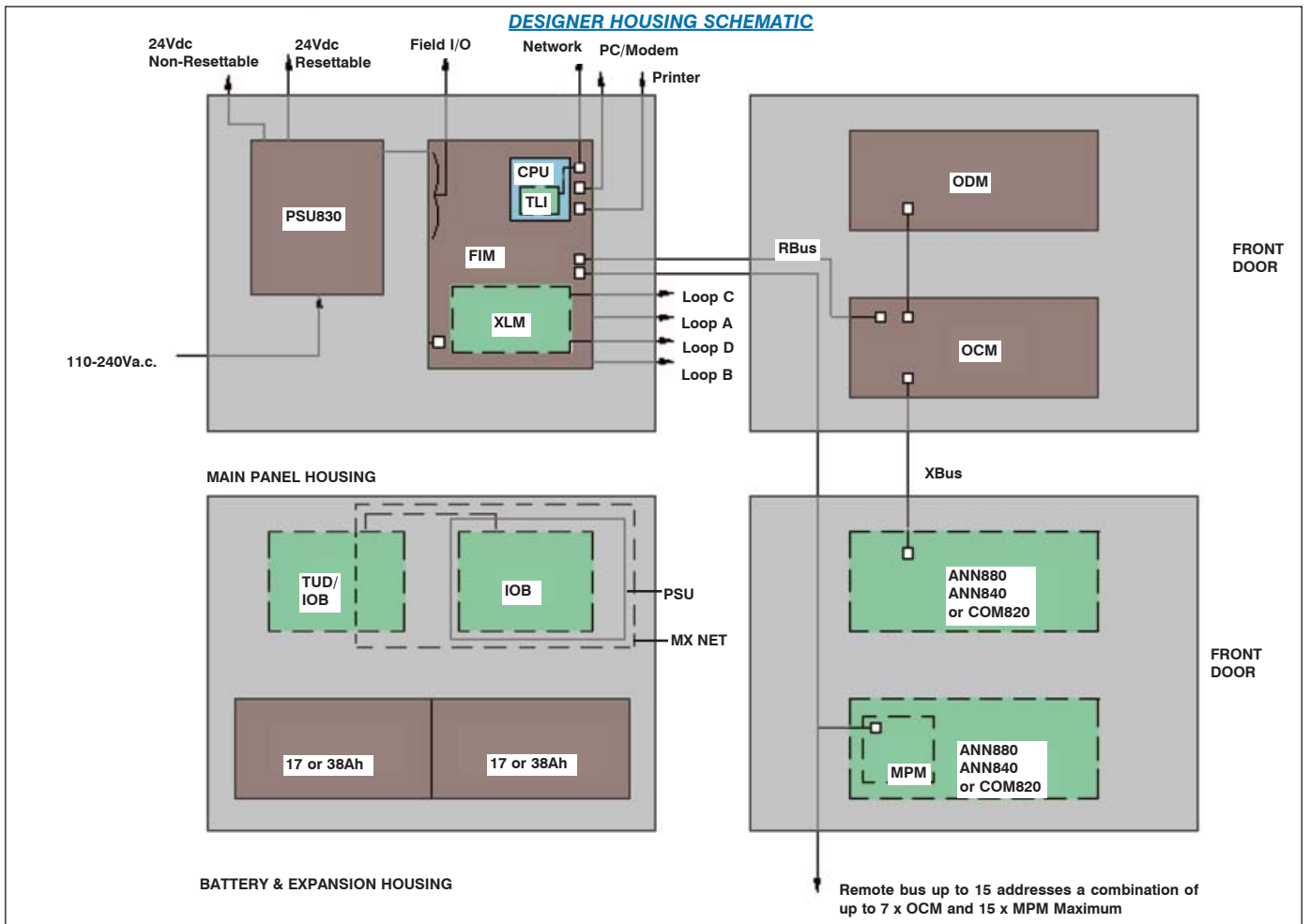

MX Panel Components

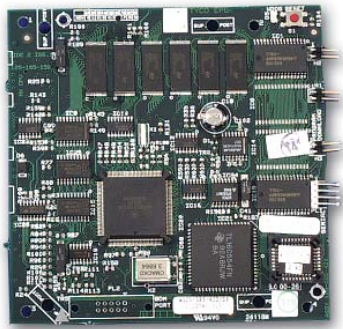

CPU Central Processor

The CPU-800 provides the main processing power behind the MX detection panels. It is a multi-layer PCB and contains the CPU, the memory and interface electronics. The CPU-800 plugs into the Field Interface Module (FIM800).

Technical Specification

32 bit Processor:	Motorola 68331
Data Memory SRAM:	1 MByte
Prog. Memory Flash EPROM:	2 MByte
Config. Memory Flash EPROM:	1 Mbyte
Boot EPROM:	64 kByte
Number of serial Interfaces:	4
Quiescent Current:	67mA
Alarm Current:	67mA

Features

- Full alarm and fault monitoring for up to 1000 addressable points including central loop processing of MX Fastlogic expert algorithms
- Concurrent operation of the main user interface and 2 remote user interfaces including one remote dial up or networked user interface
- Cause and core effect using up to 1000 input, output groups, delay timers and logic functions

The CPU-800 contains a Data Memory (SRAM), a Program Memory (Flash EPROM), a Configuration Memory (Flash EPROM) and a Boot ROM (EPROM). The use of flash EPROM allows program upgrades without the need for changing chips.

Product Code

557.202.002 CPU800 standard MX central processor



MX Loop Expansion Module

The XLM800 Loop Expansion Module fits “piggyback” style onto the FIM or an existing XLM 800 and is used to:

- Expand the capability of the MX4000 C.I.E. two loop system to eight loops.
- Replace the FIM loops in case of a failure on either a two or four loop system.

Technical Specification

Dimensions: 17.5H x 104W x 196Dmm
Battery Requirements: Standby 104.3mA+loop current
Alarm 105.3mA + loop current
Loop Current 495mA maximum

Features

- MX Digital Loop Protocol
- Extensive Loop Protection
- Interfaced to FIM 800 module

The XLM800 Loop Expansion Module controls the communications between the detectors (and other ancillaries) connected on the 2-wire loop circuits and the controller. In addition, the addressable interface contains line isolation circuits which protect the loop driver circuit from short-circuit conditions.

Product Code

557.202.007 XLM-MX Two Loop MX Digital Expansion Card



FIM800 Field Interface Module

The Field Interface Module FIM is the main interface for field wiring on MX detection panels and contains plug-in field wiring terminals, inter board connectors, EMC protectors and filters and general I/O electronics.

The FIM801 and FIM801CV provides 1 x MX DIGITAL loop and the FIM802 provides 2 x MX DIGITAL loops. Each MX DIGITAL loop can support several kilometres of loop wiring using a mixed topology using multiple loops and spurs.

The FIM provides up to 495mA of loop power to each loop to drive loop powered sounders and other loop power devices. An optional plug-in additional loop cards (XLM800-MX) provide up to 8 x MX Digital loops.

The FIM incorporates the following local I/O connections:

- 2 x reverse polarity monitored sounder outputs
- 2 x volt free outputs (Default alarm and fault)
- 1 monitored input (eg. Day/Night changeover)
- 1 emergency alarm input
- 1 unmonitored input (eg. Class Change or Tamper)
- Full monitoring of power supply
- Ground fault monitoring

Technical Specification

Dimensions:	25H x 105W x 196D mm
Weight:	156g
Power Consumption:	119mA (Quiescent - excluding loops and operator interface) 169mA (Alarm)
Relay Outputs:	30Vdc @ 2A
Monitored inputs:	10k Ohm EOL, 3KHz in parallel
RBUS:	RS-485 , default 19.6kB, up to 1200m
Serial Ports:	RS232C, 19.6kB, up to 10m
Local I/O Expansion:	Up to 2 modules, up to 24 I/O, max. 300mm

Features

- Interfaces to CPU & XLM modules
- 3 Download/Network & Printer ports
- Up to 2 MX Loops

The FIM incorporates a local I/O bus which allows the local I/O connections to be increased by 24. A variety of I/O expansion boards are available including:

- IOB800 (8 in/8 out) expansion board

The FIM includes two connections to the RBUS one for the local user interface and one for connecting up to 15 remote addresses in the form of up to 2 x operator control modules (OCM800) or up to 15 multi-purpose modules (MPM800).

The FIM provides 3 configurable external serial ports :

- Port 1 Local printer
- Port 2 Configuration PC or remote diagnostics and upload/download modem
- Port 3 FSI open protocol or Network card/gateway TLI800EN (not provided on FIM 801CV)

Product Codes

557.202.000	FIM801 field interface module with one MX loop driver
557.202.001	FIM802 field interface module with two MX loop drivers
557.202.008	FIM801CV for Marine T2000 CV



Features

- Universal Input Voltage
- Temperature Compensated
- Full Fault Monitoring
- Can drive 4 fully loaded MX digital loops
- When used with second PSU830 and MX2 8 loop expansion kit can power 8 fully loaded MX digital loops
- Same footprint and fixings as the PSB821
- Replaces PSB820 and PSM820
- Meets the requirements of EN54 part 4 amendment 2

PSU830 Power Supply

The MX PSU830 power supply module is a state-of-the-art integrated switch mode system power supply and battery charger, which can provide up to 5A external and auxiliary loop power during alarm conditions.

The charging voltage is temperature compensated. The power supply recharges the batteries within 24hr for the following timings:

- 90hr stand by time and 15 minute alarm condition.
- 72hr stand by time and 30 minute alarm condition.

The power supply provides full condition and fault monitoring to the system via the FIM. The PSU830 incorporates a booster module to provide the correct voltage levels to maximise the performance of the MX DIGITAL protocol.

Fault signals (Loss of AC, Battery charger fault, Battery fault and earth fault) are provided. Battery voltage readings are also provided to the FIM and a volt free fault o/p is also provided.

Screw terminals provide 2 x 27V outputs (one with reset control) and one 5V output. The power supply is fitted in a steel cage with mounting points to allow any of the following boards to be mounted:

- APM800 addressable power supply monitor module.
- FB800 fuse board with 15 x 24Vdc fused spurs.
- IOB800 input/output expansion board.
- PTM800 power terminal module.

The MX2 PSU830 Dual PSU Kit is required to power the XLM800 pcb on 6 to 8 loop systems which require the extended loop power capability. It consists of the necessary cables & connectors to enable an additional PSU830 to be fitted to an MX2 controller.

Technical Specification

Dimensions (HWD):	62 x 132 x 242mm
Electrical Characteristics:	
Input Voltage:	120-240Vac -15% /+10% 50/60Hz (auto ranging)
Input Current Rated Load:	0.8-2.2A ^{RMS}
Output Voltages	27.3Vdc @ +25°C
Non-reset:	27.3Vdc @ 2A 5Vdc @ 2.2A 40Vdc @ 2.2A
Reset:	27.3Vdc @ 2A
Rated Output	
Maximum Alarm current	5A for 30 minutes
Maximum continuous load current (excluding charging):	2.5A
Battery Requirements	
	17Ah or 38Ah single PSU
	65Ah dual PSU
Standby Current Consumption:	90mA @ 24Vdc
Battery Fault High Resistance:	
Single PSU:	0.6 Ohms
Dual PSU:	0.3 Ohms

Product Codes

557.202.210	PSU830 Power Supply Module
557.201.232	PTM800 Power Terminal Module
557.201.231	MX2 PSU830 Dual PSU Kit
557.202.044	PSU 830K Power Expansion Kit
557.202.030	PSU 830 Panel Fixing Conversion Kit
557.202.031	PSU 830 Small Chassis Plate Conversion Kit
557.200.014	MXAPSU17 Boxed Addressable PSU (17A/H)
557.200.015	MXAPSU38 Boxed Addressable PSU (38A/H)

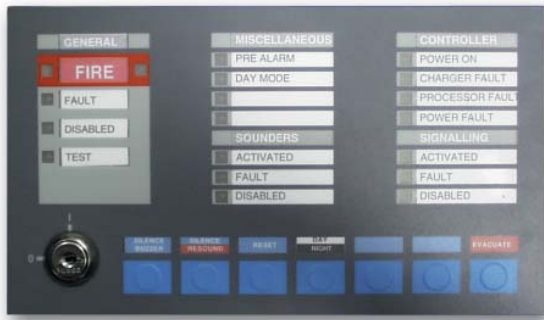

OCM800 Operator Control Module

The OCM800 is utilised by all MX detection panels and full function repeaters to provide mandatory operator control and LED indication functions to comply with EN54:pt.2. The OCM800 is fully programmable but operates in default configurations according to the software template used.

Most software templates allow several of the LED's and control buttons to be programmed for site-specific functions. The LED's and control buttons both have slide in legends to suit the default configurations and language. Standard panels include the appropriate legends for their relevant markets.

The OCM800 incorporates the functionality of an MPM800, which allows it to drive an operator display module to provide a complete panel user interface.

Technical Specification

Dimensions:	50H x 232W x 133D mm
Weight:	0.272Kg
Power Consumption:	35mA (Quiescent) 36mA (Lamp test) 81mA (Alarm)
Control Buttons:	7
Indication LED's:	18
Communications:	RS-485: RBus –Default 9.2Kb
Expansion Bus:	MX X-Bus
Legends for LPCB modules:	UK/English, Marine

Features

- Changeable Legends
- Fully programmable
- Optional I/O via R-Bus

In addition the OCM800 can drive up to 80 inputs/outputs using one of the following modules.

The following I/O and LED annunciator modules can be slaved from an MPM800:

- Up to 5 x IOB800 (8 in/8 out LPCB/VdS approved expansion board)
- Up to 5 x XIOM (16 way universal I/O board)
- One Mimic Panel (80 way LED mimic driver PCB)
- One 80 way ANN880 LED mimic
- One 40 way ANN840 LED mimic using red & yellow LED's
- Two 20 way COM820 LED status/command modules

Up to 2 x OCM800 units can be connected to an MX panel via the internal or external RBus communication port.

Product Code

557.202.013 OCM800 with Minerva MX Inserts



Features

- 0-9 alpha-numeric phone style keypad
- Up and down scroll keys
- Five function keys

ODM800 Operator Display Module

The ODM800 operator display module provides a powerful and flexible 40 x 16 character backlit LCD display used by all MX detection panels and full function repeaters. The ODM800 is used with the OCM800 to provide a fully compliant and approved user interface EN54 fire detection panel.

The ODM800 is powered and controlled by the OCM800 operator control module and provides various functions according to the panel software.

Standard EN54 panels use the LCD display as five windows on the system.

- Window 1-Details of first detector in alarm
- Window 2-Details of the most recent detector in alarm
- Window 3-System Status including Alarm/Fault and Isolate counters
- Window 4-Full alarm/event details and lists including 95 character procedure plus full password controlled system manager, service and engineering menu structure
- Window 5-Function key legends (eg. Back, Enter, >>, <<)

Technical Specification

Dimensions: 25H x 232W x 133D mm
 Weight: 0.361Kg
 Power Consumption: 50mA (Quiescent)
 900mA (Alarm Backlit)
 50mA (Alarm during mains failure)

Product Code

557.202.019 ODM800 operator display module

OCM800 to IOB800 Connection Details

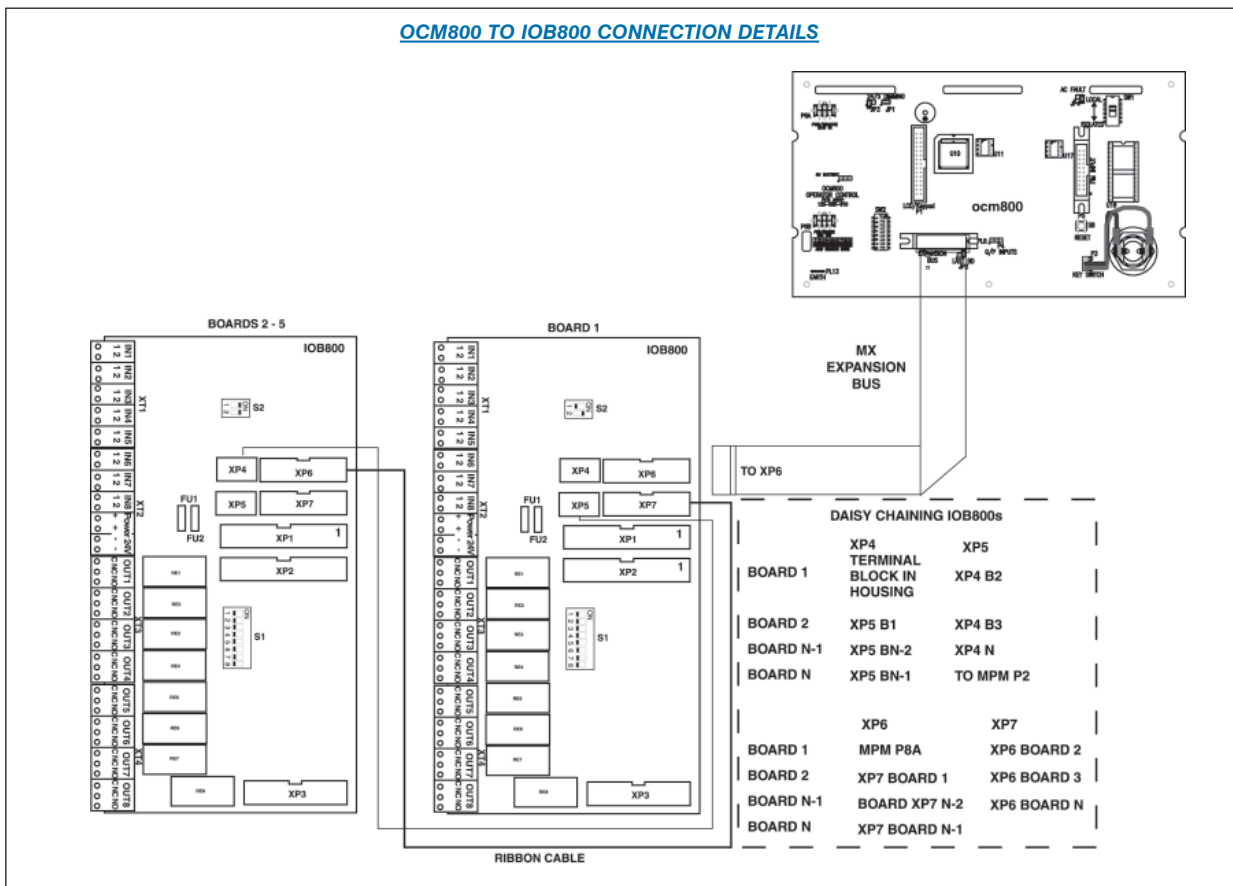

ANN840 LED Annunciator



The ANN840 is a standard LED annunciator user interface module which can be driven from an OCM800 or an MPM800. The MPM800 can be mounted remotely or "piggy-backed" on the ANN840. The ANN840 has removable legends for 40 zone status indicators. Each zone can indicate RED (eg. Alarm) and YELLOW (eg. Fault & Isolate). The functionality is programmed in the MX detection panel. The ANN840 operates as 80 outputs (RED & YELLOW).

Technical Specification

Dimensions: 25H x 232W x 133D mm
 Weight: 177g
 Power Consumption:
 1mA + MPM800 (Quiescent)
 85mA + MPM800 (25% zones in alarm (Alarm))
 340mA + MPM800 (Lamp test)

Product Code

557.202.021
 ANN840 LED annunciator

ANN880 LED Annunciator



The ANN880 is a standard LED annunciator user interface module, which can be driven from an OCM800 or an MPM800. The MPM800 can be mounted remotely or "piggy-backed" on the ANN880. The ANN880 has 80 red LEDs numbered 1 to 80. The functionality is programmed in the MX detection panel but is defaulted to zone alarm LED's.

Technical Specification

Dimensions: 25H x 232W x 133D mm
 Weight: 177g
 Power Consumption:
 1mA + MPM800 (Quiescent)
 85mA + MPM800 (25% zones in alarm (Alarm))
 340mA + MPM800 (Lamp test)

Product Code

557.202.022
 ANN880 LED annunciator

COM820 Status Command Module - 20 Way



The COM820 is a standard user interface module, which can be driven from an OCM800 or an MPM800. The MPM800 can be mounted remotely or "piggy-backed" on the COM820. The COM820 has removable legends for 20 status command functions. Each function includes a command button and a yellow status LED. The functionality is programmed in the MX detection panel. Typical applications include:

- . Manual/OFF/Auto/Isolate functions for evacuation or plant control
- . Selective isolate and evacuate functions for fireman's control
- . Selective plant shutdown and override functions
- . Selective system delay and timer functions
- . 2 can be driven from 1xMPM800.

Technical Specification

Dimensions: 25H x 232W x 133D mm
 Weight: 204g
 Power Consumption:
 0.267mA (Quiescent - No LED's)
 5mA (Alarm - 25% LED's)
 21mA (Lamp test)

Product Code

557.202.020
 COM820 Status/Command Module

Remote Mimics



The 80-Way Mimic allows custom-made display and presentation panels to be incorporated in the MINERVA MX addressable system. It is supplied as a single PCB, which may be mounted in an expansion box or on the rear of a free-standing panel, as required. It may be used to drive up to 80 zonal LED indicators, arranged in any configuration, together with two FIRE LEDs, one FAULT LED and one ISOLATE LED. These indicators can operate in the same manner as the corresponding indicators on the panel. A remote Mimic can be connected to the MPM800's configured as remote Mimic drivers via the remote bus. Up to 15 MPM800's may be connected on to the remote bus, each with a unique address [set on-board]. The Mimic includes audible and visible warning facilities.

Technical Specification

Dimensions: 235H x 190Wmm
 Operating Temp: -10°C to +55°C
 Storage Temp: -20°C to +65°C
 Relative Humidity: Up to 95% RH Non-Condensing
 Power Consumption: 11mA (Quiescent)
 200mA (25% Alarm)
 800mA (Lamp Test)

Product Code

557.180.005
 MINERVA 80 way mimic driver module



Features

- Drives up to 80 I/O points
- Direct Interface to Zonal Displays and other Modules
- Interfaces to FIM Board

MPM800 Multi Purpose Interface Module

The MPM800 is used to provide various expansion capabilities via the remote bus (RBUS). The MPM800 is provided as a standalone module but is also incorporated into the circuitry of the OCM800 operator control module to drive the LCD display, LEDs, keyswitch and keys on the OCM800 and the operator display module. The OCM800 and MPM800 have an XBUS which can be used to drive up to 80 I/O. The MPM800 also has a printer interface for connecting to a serial or parallel printer.

An additional printer driver kit is required to allow the MPM800 to drive a printer - a serial isolation module should be used to eliminate earth fault indications caused by some mains connected printers.

Up to 15 x MPM modules can be connected to each panel of which 8 can be in the form of OCM800 (including the main OCM800 user interface). One OCM800 can also be in the form of an emulated user interface on a remote PC connected via the network or dial up modem. The following I/O and LED annunciator modules can be slaved from an MPM800:

- Up to 5 x IOB800 (8 in/8 out expansion board)
- Up to 5 x XIOM800 (16 way universal I/O board)
- One Mimic Panel (80 way LED mimic driver PCB)
- One 80 way ANN880 LED mimic**
- One 40 way ANN840 LED mimic using red & yellow LEDs**
- Two 20 way COM820 LED status/command modules**

The MPM800 is mounted by plugging directly onto the back of those items marked **

Technical Specification

Dimensions:	25.4H x 92W x 167.64D mm
Weight:	98g
Power Supply:	24Vdc (from PSU830)
Communications:	RS-485, up to 19.6kB
Printer Connection:	Serial or Parallel

Product Codes

557.202.012	MPM800 multi-purpose interface modules
557.202.117	Serial printer cable for MPM800 or FIM800
557.180.052	Serial Printer Driver Kit only required for earlier MPM800 Modules
557.180.053	Isolated RS485 IC (for U16)

XIOM Input/Output Expansion Board



The XIOM is a 16 universal input/output expansion board.

The I/O on the XIOM can be set in banks of 8 to operate as follows:

- LED driver outputs (10mA source)
- Relay Driver Outputs (100mA sink)
- Voltage Monitor Input (8 - 30Vdc Normal)
- Volt Free Contact inputs

Features

- 16 I/P's or 16 O/P's or 8 I/P + 8 O/P
- 5 per MPM800 (80 I/O points)
- Fully configurable in MX consys

Technical Specification

Dimensions: 144H x 85W x 15D mm

Product Code

557.180.016
XIOM MINERVA Input/Output Expansion Module (16 Way)

FB800 Fuse Board

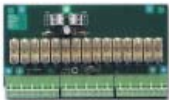

The FB800 fuse board provides terminations for 15 fused 24Vdc output spurs from a single 24V d.c. input. The FB800 is designed to be normally mounted on the PSU830 power supply. The fuses are rated at 500mA.

Technical Specification

Dimensions:
93H x 165W x 80D
mm
Weight: 149g
Input: 24Vdc
Output: 15 x 24V d.c / 500mA
Terminations:
2.5mm

Product Code

557.202.100
FB800 fuse board (15 way)

IOB Input/Output Expansion Board



The IOB800 is an LPCB approved board that provides 8 opto-isolated digital inputs and 8 x 24V d.c. relay outputs for providing I/O expansion capabilities to MX detection panels for interfacing to other subsystems and signalling devices. The IOB800 also incorporates a connector, which provides decoded signals for the 8 inputs and 8 outputs for specialist interfacing.

The IOB800 can be used to provide expansion I/O to the following MX panel components:

- FIM801/802 field interface modules (maximum 24 I/O 8IN/16OUT)
- OCM800 operator control modules (maximum 80 I/O)
- MPM800 multi-purpose interface (maximum 80 I/O)

The IOB800 can be mounted in the top of a battery box or repeater. The IOB800 has two expansion bus connectors which allow them to be daisy chained together.

Technical Specification

Dimensions:
15H X 164W X
80Dmm
Weight: 153g
Terminations:
1.5mm

Product Code

557.202.006
IOB800 Expansion Board and cables



Features

- High level interface to building automation systems
- Meet interfacing requirements for large integrated projects

Displayed on BACnet Client side:

- Zone alarms, point alarms from fire inputs
- MZX panel faults, faults from zones and points
- Mains fault, System faults
- Pre-alarms and alarm warnings
- Isolation of zones, loops & points
- Day/Night Mode status
- Analogue values of automatic detectors

Supported commands issued from the BACnet Client side:

- Silence, Resound
- Sounders On and Off
- Evacuate
- Fire Reset
- Isolation of zones and points

MZX BACnet Interface

BACnet can be provided from a stand-alone MZX Technology panel or from an MZX network via the MZX BACnet converter.

The MZX BACnet converter is a mini RISC-based embedded computer which converts fire data to the BACnet communications protocol. The converter needs special firmware that is simply uploaded from a PC.

Technical Specification

Mechanical

Weight:	130 g
Dimensions:	67 x 22 x 100.4 mm
Mounting:	DIN-Rail, wall
Operating Temperature:	-10 to 60°C
Operating Humidity:	5 to 95% RH
Storage Temperature:	-20 to 80°C

Electrical

Input Voltage:	12 to 48 VDC
----------------	--------------

Product Code

557.202.135 BACnet Converter for MZX

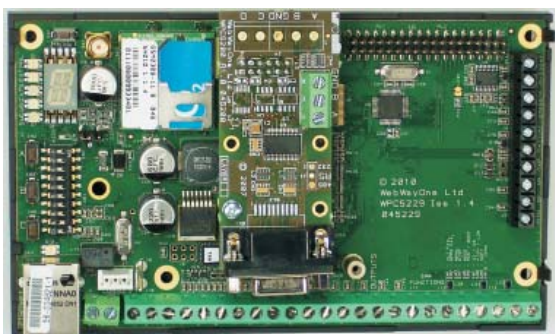

Features

- A cost effective digital communication platform to enable a range of remote services
- Robust dual path transmission over the clients IT network and the GPRS network, ensures continuity of communication in the event of a failure
- Regular polling of the IP path and the GPRS path confirms successful end to end communication - a failure will be reported within 3 minutes
- Secure communication is ensured by AES encryption with a 128 bit key and 256 bit hash code
- BRE approved to EN 54-21 for fire alarm transmission and fault warning routing equipment and LPCB Red Book listed
- Supplied with an activated 0₂ SIM card
- All access is securely controlled and logged

RS800-IP/GPRS - IP Communication Module

The RS800-IP/GPRS module connects to an individual or a network of MZX, MX, MX2 and T2000 fire control panels to provide a cost effective, secure and robust IP (Internet Protocol) based communication platform for alarm signalling, fault reporting and a range of remote services.

The RS800-IP/GPRS module connects to the communication ports and relays of a fire control panel and converts the RS232 and digital data into IP data that can be transmitted over the internet.

Communication is dual path. The primary path is the clients IP network, eliminating the additional cost of a traditional PSTN telephone line. Efficient, digital communication puts negligible demand on the network and ensures future compatibility as the traditional analogue systems are progressively phased out.

The GPRS mobile communication network is the secondary path and maintains communication in the event of a failure of the primary path.

Technical Specification

RS800-IP/GPRS

Type:	Dual Path Ethernet / GPRS EN 54-21 Alarm Transmission and Fault Routing Equipment Fire Alarms and Fault Warning Type 1 - Dual Path LPS 1277 Fire Type 1
Transmission protocol:	UDP/IP
Encryption:	AES standard with a 128-bit key and 256 bit hash code
Data bandwidth:	160 bytes (round trip including alarm and acknowledgement)
Approvals:	BRE 0832-CPD-1565: EN 54-21: 2006 LPCB Red Book to LPS1277
Power Supply:	From the connected panel's EN 54-4 power supply
Power Consumption:	100 mA / 24 VDC
Dimensions:	160 x 95 x 40 mm
Weight:	0.2 kg
Housing:	To be mounted in an IP30 / Access Level 2 metal enclosure, close coupled to MZX panel.

Enclosure for RS-800

Dimensions:	237 x 161 x 58 mm
Weight:	1 Kg
Material:	1.2 mm Mild Steel
Finish:	RAL 7035 Semi Textured
Ingress Protection:	IP30
Access Level:	2

Product Codes

557.202.090	RS800 WebWay IP/ GPRS For alarm signalling, fault reporting and remote IP services. Includes cables, SIM and first year's service
557.202.091	RS800 WebWay IP For remote IP services only. No GPRS SIM included. Includes cables and first year's service
557.202.093	Enclosure for RS-800
22-5054	WebWay Smart Disc Eng Pack High performance antenna with roaming SIM
22-5049-10M	WebWay High Gain Eng Pack High gain extension antenna with roaming SIM and 10m cable
22-5049-15M	WebWay High Gain Eng Pack High gain extension antenna with roaming SIM and 15m cable

Chapter 2 - MZX Technology

Desktop Printer



The printer is designed as a low cost business printer ideally suited for mounting adjacent to the fire control panel. The LQ-300+ combines high performance with paper handling flexibility and quiet operation.

Features

- 300 cps draft/ 90cps LQ.
- Quiet operation
- Lightweight and compact design
- 9 LQ fonts
- 2 paper feed paths
- Convertible push/pull tractor
- Paper guide
- Auto loading
- Paper park

- Cable feed recess
- Epson LQ standard terminal emulation available
- Parallel and serial interface

Technical Specification

Dimensions: 159H x 366W x 275D mm
Weight: 4.4kg
Operating Voltage: 180V to 264Va.c.

Product Codes

557.180.239
MINERVA printer LQ-300+
557.180.220
LQ 300+ Printer Ribbon (spare)
557.202.117
MX FIM/MPM to serial printer lead

In-Built Printer



The PRN800 Printer Kit is designed for use with the designer range of MX Controllers (MX4000 and T2000). It is fitted to the front cover of the MX battery housing and is powered from the PSU830 power supply via an FB800 fuseboard in the MX Controller housing.

Features

- A thermal printer mechanism which ensures high reliability.
- Quiet Operation
- Lightweight and Compact Design
- High Speed Printing: 40mm per second.

- High quality printing: 384 dots.
- 40 Columns
- Friction paper feed

Technical Specification

Dimensions: 230H x 137W x 85D mm
Weight: 0.38Kg
Operating Temp: +5°C to +45°C
Storage Temp: -20°C to +70°C
Relative Humidity: Up to 80% non-condensing
EMC: 61000-6-3 for emissions
BS EN 50082-1 for immunity

Product Codes

557.202.024
PRN 800 Printer c/w front cover module
557.301.014
Spare Paper Roll (pk of 5)

Remote LCD Display



The Remote LCD Repeater Module is designed to provide an independent scrolling log of system status at numerous points within a building or site. The module interfaces directly to a serial printer port of the MX addressable fire panel. If a local printer is already connected to the Panel's MPM800 serial port, a second MPM800 must be used.

Features

- Uses a backlit 4x20 character alphanumeric display.
- Provides an internal log of up to 330 events.
- Provides internal audible warning of an event.
- Allows the event log to be scrolled.
- Local internal buzzer silence.
- Connects to host panels RS232 port (maximum cable length between panels and first repeater of 15m).
- Provides an external sounder to mimic the internal buzzer.
- Can be connected to an unlimited number of other LCD Repeaters by using the RS232/RS422 converter (Up to 1200m between repeaters).

The LCD repeater must not be used in the primary fire path. It must not be used as the sole warning that a fire exists.

Technical Specification

Dimensions: 150H x 200W x 75D mm
Material: Bayblend polycarbonate/ABS alloy
Operating Temp: -10 C to +55 C
Relative Humidity: Up to 95% RH Non-Condensing
Power Supply: 200mA @24Vdc
Ext. Sounder Relay: 500mA@24Vdc
EMC: Product Family Standard EN50130-4 in respect of Conducted Disturbances, Radiated Immunity, Electrostatic Discharge, Fast Transients and Slow High Energy. EN61000-6 3 -1 for Emissions.

Product Codes

557.200.030
Remote LCD Repeater MKII (compatible with Version 4.1 and above for UK/UL/Marine/Western European Countries)
557.202.128
MX FIM com1 to RS422 Lead
557.180.151
RS232/422 converter for LCD Repeaters.

DDA Compliant Pager



Fire Tek Pro Paging System

The FireTek Pro paging system is designed for use with professional Fire Systems installed in commercial, industrial and educational premises. The system is primarily designed to alert the “hearing impaired” in the event of a fire or other emergency where an audible sounder is the normal means of indication.

The FireTek Pro has been designed to comply with the recommendations detailed in BS5839-1: 2002 for alerting the “hearing impaired” to the activation of a fire alarm system.

The system can also be used in conjunction with a security panel to alert guards who might be located remotely from the main premises.

The interface to the fire panel comprises of three Prioritised Fire Inputs and two Fault Inputs. For ease of installation, a monitored cable assembly is provided with each system which includes a “common fault” relay output back to the host fire panel. This output will activate if the FireTek Pro suffers a mains failure, transmitter fault, antenna mismatch, interface link failure, or low battery state.

Upon activation of any one of the Fire Inputs, the FireTek Pro will enter the fire alert condition, prioritising and transmitting the Fire message to all enrolled pagers. The transmissions will be repeated until the fire condition is reset. The FireTek Pro Pagers ensure that users are alerted by distinct vibration patterns and clear text messages.

UHF Radio Operation

Any alerting system is only as good as its weakest link. The FireTek Pro utilises UHF radio frequencies, the main benefits being superior in-building radio signal propagation and the option of a manual frequency co-ordinate license issued by OFCOM. Licensing the FireTek Pro provides a higher degree of protection from interference. This fact is acknowledged in Section 18.1 of BS 5839-1:2002.

Features

- UHF radio link for maximum licensable protection
- Unique coding avoids neighbouring system clashes
- Self monitoring of system health
- Rugged steel enclosure to IP65
- Backlit 2 line text display continuously reports system status
- Additional audible & visible status indicators
- Prioritised Fire Alarm Inputs
- Automated test calls alert pagers to loss of radio signal
- Fault Notification to the lost fire panel via a monitored link
- Key operated “System Test” facility for routine confidence checking
- Over 90 hour’s backup operation with internal battery
- Achieves Disability Discrimination Act (DDA) compliance

High Integrity Pagers

To complete the system the alphanumeric pagers have added features specifically incorporated for the “hard of hearing” when used with the FireTek Pro. These features include distinct vibrate alerts for emergency messages, a vibrating out of range indicator which displays “No Service” on the pager when the radio link is lost, and a vibrating low battery indicator.

Antenna Options

Mini Dipole Antenna - remote internally mounted antenna for large sites or areas of difficult signal propagation.

Folded Dipole Antenna - remote externally mounted antenna for maximum signal coverage e.g. campuses and multi-building sites.

Chapter 2 - MZX Technology

Technical Specification

Supply Voltage:	230V AC 50-60 Hz 12v 7Ah standby battery
Operational Current:	250mA
Inputs:	3 Prioritised Volt Free (Fire) Input 1 - Fire Alarm - Evacuate Building Input 2 - There is an Incident - Leave Building Input 3 - Prepare to Evacuate - Await Instructions
Outputs:	2 Volt Free (Fault) 1 off volt free relay output
Fault Notification:	Mains Failure Transmitter Fault Antenna Mismatch Panel Link Failure Low/Missing Battery
Visual Display:	2 Line Backlit LCD
Enclosure:	Steel Enclosure rated to IP65
Dimensions:	380 x 320 x 110 mm (H x W x D) (No antenna fitted)

Product Codes

557.200.071	Paging Transmitter
557.200.074	40 Character Alpha Numeric Pager
557.200.076	1/2 wave dipole antenna
557.200.077	Wall mounting folded dipole antenna
557.200.078	Pole mounting folded dipole antenna
557.200.079	5 metre antenna feeder cable
557.200.080	10 metre antenna feeder cable



Features

The pagers:-

- Display messages sent out by the MX as displayed on the MX LCD
- Internal log of up to 40 events
- Audible and/or vibrate warning of event
- Allows the event log to be displayed

The transmitter:-

- Connects using a 9 way D type MX interface lead to MX printer port

Pager Interface

The MX pager system is designed to provide a facility to signal all text messages or alarm/fault messages from a local transmitter to the pagers.

The transmitter connects to the serial printer port on the FIM800 or if already in use to a MPM800. The pager system requires a +12V d.c. connection from a remote psu. If the transmitter needs to be located further than 2 m from the MX Panel, then a non-standard serial printer cable may be used, up to a maximum distance of 14m.

The Type A alarm pager displays alarm and critical fault messages, (ie power supply failure or mains failure).

The Type A maintenance pager displays all messages sent by the fire controller.

CAUTION: Before any installation is carried out, an on site radio paging license must be obtained by the customer. Care should be taken when designing pager systems. Normal practice indicates that a site survey should be done. Contact Product Management for additional advice on site surveys.

Technical Specification

Dimensions:	328H x 190W x 75D mm
System operating voltage:	12 to 13.8Vdc
Effective radiated power:	500mW Max
Frequency range:	450-470 MHZ
Channel spacing:	25KHz
TX baud rate:	512 or 1200
Type approval	ETS 300 224, EC type approved to ETS 300 682

[Manual - Vol17A-2-Pager](#)

Product Codes

557.200.029	Pager Transmitter
577.002.002	Type A alarm pager
577.002.003	Type A maintenance pager
577.002.007	Pager aerial 60 db gain up to 1km (c/w mounting bracket)
577.002.008	Optional feeder cable (10m long)
G13801N-A	Elmdene 12V 1A PSU in Housing

Generation 6 Fire Detectors



Features

- Advanced multi-sensor designs
- Choice of heat, optical, optical and heat multi-sensor or 3oTec triple multi-sensor
- FASTLOGIC expert algorithms
- Up to 250 detectors per loop
- Built-in line isolator on 850 series
- Advanced commissioning features using the 850EMT Engineering Management Tool
- Two way infra-red communication to the 850EMT Engineering Management Tool
- Protective optical chamber screen
- Robust coated electronics
- Extended service life
- Fire, isolate and fault LED indications
- Green Passport Certified

850 and 830 Series Fire Detectors - Generation 6 - IEC 61508 Approved (SIL2)

The 850 and 830 series of fire detectors are designed to be both adaptable and flexible which means they can be used in most premises to protect against a wide range of potential fire risks. They use sophisticated digital signalling to communicate with the MZX Technology fire control panel, sending fire data from each sensing element for analysis. Because all of the sensed data is sent to the controller, powerful algorithms can be used to determine whether a fire condition is real or not. The sensitivity, mode and degree of verification can be altered by the user in response to environmental or activity changes.

A built-in line isolator incorporated into the 850 series devices means that when a single short circuit fault occurs on a loop, all the detectors will continue to operate. An on-board amber LED will give a local indication that the line isolator has operated. The 830 series detectors can be used with an isolator base to provide protection against short circuit faults.

Two way infrared communications allows the detector to work with the 850EMT Engineering Management Tool to speed up commissioning and service routines and to provide status / reports data without the need to physically access the device. Extended drift compensation reduces the lifetime cost of ownership by typically doubling the service life of the detector whilst a new insect screen and surface coating of electronics results in a robust industrial design.

Both 850 series and 830 series detectors are environmentally friendly. They do not use any radioactive parts and can be returned for recycling at the end of their life.

The detectors are constructed from hardwearing flame retardant FR3010 'BAYBLEND' plastic. They are supplied with dust covers as part of the packaging which essentially prevents contamination entering the detection chambers during installation, after which they are removed.

850PH, 851PH and 830PH Photo Heat Multi-Sensor Detectors



With its ability to detect a wide range of fires from flaming to smouldering types, the combined optical and heat multi-sensor detector is the preferred choice for a range of applications including light industrial, retail and office environments.

It operates in a number of approved modes and sensitivities that can be dynamically selected to suit different environmental conditions.

Technical Specification

Detector material: Flame Retardant FR3010 'BAYBLEND'
Dimensions: Height 43mm
Dia.109mm
Colour: White
Weight: (Excluding Base)76g.
Voltage: 20 – 40 VDC
Quiescent Current: 380uA
Alarm Current: 3.3mA
Operating Temp: -25 °C to +70 °C
Storage Temp: -40 °C to +80 °C
Relative Humidity: 95% (non-condensing)
Approvals: EN54-5 and EN54-7,CPD, VdS
Type Approval: CEA4021
851PH MED Approved

Product Codes

516.850.051
850PH Photo Heat Detector with built in line isolator
516.830.051
830PH Photo Heat Detector
516.850.055
851PH Photo-Heat Detector with built in line isolator Marine

850P and 830P Photo Detectors



More benign environments where any potential fire will be slow burning can be protected using the optical detector. A choice of sensitivities and modes gives this detector a broad range of applications.

Technical Specification

Detector material: Flame Retardant FR3010 'BAY BLEND'
Dimensions: Height 43mm Dia. 109mm
Colour: White
Weight: (Excluding Base)76g.
Voltage: 20 – 40 VDC
Quiescent Current: 380uA
Alarm Current: 3.3mA
Operating Temp: -25 °C to +70 °C
Storage Temp: -40 °C to +80 °C
Relative Humidity: 95% (non-condensing)
Approvals: EN54-7, CPD, VdS Type Approval
CEA4021

Product Codes

516.850.052
850P Photo Detector with built in line isolator
516.830.052
830P Photo Detector

Chapter 2 - MZX Technology

850H and 830H Heat Detectors



Complimenting the range is the heat sensor which can operate in fixed temperature and rate-of-rise modes with a number of approved sensitivities. It is most often used in areas where high levels of dust are present or where the environment precludes the use of smoke detectors.

Technical Specification

Detector material:
Flame Retardant
FR3010 'BAYBLEND'

Dimensions:
Height 43mm Dia.
109mm

Colour: White

Weight: (Excluding Base) 81g

Voltage: 20 – 40 VDC

Quiescent Current:
335uA

Alarm Current:
3.3mA

Operating Temp:
-25 °C to +70 °C,

Short-term:
to +90 °C

Storage Temp:
-40 °C to +80 °C

Relative Humidity:
95% (non-con
densing)

Approvals: EN54-5, CPD, VdS Type
Approval MED Approved

Product Codes

516.850.053
850H Heat Detector with built in line
isolator
516.830.053
830H Heat Detector

850PC and 830PC 3oTec Triple Sensor Detectors



3oTec Triple Sensor Detector



For life protection and when the environmental conditions are challenging, the 850PC/830PC 3oTec detector provides the ultimate in detector performance and false alarm rejection. It is a multi sensor that uses optical, heat and carbon monoxide sensors in concert to accurately determine the presence of fire.

Applications include industrial, retail, transport hubs, and healthcare. Its false alarm rejection properties make it the ideal choice for hotel bedrooms where steam from bathrooms is a common source of false alarms.

Technical Specification

Detector material: Flame Retardant
FR3010 'BAYBLEND'

Dimensions:
Height 43mm Dia.
109mm

Colour: White

Weight: (Excluding Base) 94g

Voltage: 20 – 40 VDC

Quiescent Current:
420uA

Alarm Current:
3.3mA

Operating Temp:
-10 °C to +55 °C

Storage Temp:
-20 °C to +55 °C

Relative Humidity:
95% (non- condensing)

Approvals: 850PC: EN54-5 and
EN54-7, CPD, VdS
Type Approval: VdS2806, CEA4021
MED Approved

Product Codes

516.850.054
850PC 3oTec Triple Sensor Detector
with built in line isolator
516.830.054
830PC 3oTec Triple Sensor Detector

850 and 830 Series Coloured Detector Covers & Bases

The existing white cover on the 850 and 830 Series Fire Detectors can be removed and replaced with any of the below coloured covers.



Product Codes

517.050.501 Sample set of coloured detector covers and bases - set of 10
517.050.502 Detector Cover & Base in Orange Semi Gloss-pack of 10
517.050.503 Detector Cover & Base in Yellow Gloss-pack of 10
517.050.504 Detector Cover & Base in Matt Green-pack of 10
517.050.505 Detector Cover & Base in Matt Red-pack of 10
517.050.506 Detector Cover & Base in Matt Brown-pack of 10
517.050.507 Detector Cover & Base in Blue Gloss-pack of 10
517.050.508 Detector Cover & Base in Pink Gloss-pack of 10
517.050.509 Detector Cover & Base in Metallic Silver-pack of 10
517.050.510 Detector Cover & Base in Metallic Gold-pack of 10
517.050.511 Detector Cover & Base in Matt Black-pack of 10

Chapter 2 - MZX Technology

800F Flame Detectors



The 800F is a digital addressable, low cost infrared flame detector with some high end features such as 'Solar Blind' operation for false alarm free reliability and an automatic health check feature. They will detect a 0.1m² flaming fire at a range of 20m. Uses the standard MX detector bases and MX base accessories. An Intrinsically safe version is available as part of the System 800 I.S. range.

Technical Specification

Dimensions (mm): 108Dia x 21.2H
Weight: 74g
Operation Temp: -20°C to +70°C
Storage Temperature: -40°C to +80°C
Relative Humidity: 90% RH continuous (non-condensing)
Range: 0.1m² n-heptane at 50m
Field of View: 100°
Standards EN54 pt10 Certification

Product Codes

516.800.006
801F LPCB
516.800.007
811F Marine

800I Ionisation Smoke Detector



The 800I ionisation detectors are offered for old specifications which still call for ionisation smoke detectors. The 800CH and 800PH detectors offer improved performance, significantly lower false alarms and environmental compatibility for smoke detection applications. The 800I nevertheless offers state-of-the-art ionisation smoke detection with self verification, smoke level indication and threshold

compensation for detector condition monitoring. The 801I is LPCB approved.

Technical Specification

Dimensions: 109dia x 43Hmm
Operating Temp: -20 to +70°C
Storage Temp: -40 to +80°C
Relative Humidity: <95% (non condensing)
Standards: EN54 pt 7

Product Codes

801I
516.800.515.A ADT
516.800.515.T THORN
516.800.515.Y TYCO

801PS High Sensitivity Smoke Detector



The 801 PS high sensitivity smoke detector is designed for applications which require a detector with a greater sensitivity than specified within EN54-7.

Having a response to smoke of 0.6%/m makes this device suitable for use in locations where early smoke detection is required, ie cabinet protection and areas where aspirating systems would have previously been considered.

Technical Specification

Dimensions: 109 Dia x 43Hmm
Operation temp: -25°C to +70°C
Storage temp: -40°C to +80°C
Relative Humidity 95% non-condensing

Product Code

516.800.518
801PS High sensitivity smoke detector

Line Shorting Adaptor



Low profile line shorting adaptor commissioning tool (shorts terminals together enabling cable resistance checks to be carried out) - ADT Branded

Product Code

517.050.002.A
Line Shorting Adapter

GD210 Gas Detector



The GD210 flammable gas detector is designed for use in non-hazardous areas where flammable gas detection is required, typical locations include kitchens, gas fired boiler rooms, meter rooms, sub basements and cable chambers.

This detector connects via a 4-20mA interface to the DDM800 Universal Fire and Gas Module

Voltage 12-30 VDC
Power 3.5 watts
Output 4-20mA 3 wire Source
Load resistance 250 ohms (max)
Operating temp - 40 to +65°C
IP rating - 55
Cable entry 1 x M20

Product Codes

516.100.050
GD210 Flammable Gas Detector
4 - 20mA interface
516.100.013
Test Gas Kit - 12 L can of 2.5% methane (50%LEL) c/w adaptor and tube
516.100.014
Test Gas - 12 L can of 2.5% methane (50%LEL)
516.100.051
Spare Flammable Gas Detector Sensor
516.100.052
Spare Flammable Gas Detector PCB

Beam and Linear Heat Detectors

Beam type smoke detection is ideal for large open span buildings where point type detection is unsuitable i.e. warehousing & sports halls. The range of Linear Heat Detection is of particular use in tunnels and cable ducts and other similar areas.



Features

- Motorised Auto-Aligning
- Up to 4 Detectors per System Controller
- Each Detector configurable from 8m to 100m
- Integral LASER
- Auto-Align Fast Automatic BeamAlignment
- Auto-Optimise Building Movement and Contamination Compensation
- Low Level System Controller
- 20mm Cable Gland Knockouts on System Controller
- 2-wire interface from System Controller to Detector
- Worldwide Approvals including EN54:12 and UL268
- Up to 4 Detectors per System Controller

FIRERAY 5000 Multi Head Auto Aligning Infrared Optical Beam Smoke Detector

The FIRERAY® 5000 motorised, auto aligning infrared optical beam smoke detector can now be installed with up to four detector heads per system, thus saving on installation time and costs. This innovative system has been designed from the ground up to include pioneering technology that fully addresses the needs of the installer and user, both now and in the future.

With its industry leading optics, the FIRERAY 5000 is ideally suited for the protection of large areas where the use of traditional detection technologies would prove to be too difficult and/or costly to install. The FIRERAY 5000 combines an infrared transmitter and receiver in the same discrete unit and operates by projecting a well-defined beam to a reflective prism, which returns the beam to the receiver for analysis. Smoke in the beam path causes a drop in power, which, if below a pre-determined level, results in an alarm signal.

Getting the system operational is simplified by a number of groundbreaking features that combine to make the FIRERAY 5000 the quickest and easiest detector of its type to install. Once the detector heads are connected, using the Easifit First Fix system, an integral LASER, which is aligned along the optical path of the beam, can be activated. This allows the reflective prism to be sighted quickly and with confidence. Once the LASER has been used to coarsely align the beam, the AutoOptimise beam alignment system takes over and automatically steers the beam into the optimum position.

Technical Specification

Controller:	202w x 230h x 81d mm 0.9 Kg
Detector:	134w x 135h x 134d mm - 0.5 Kg
Additional detector head	2mA @ 24VDC
Operating Current (low power mode):	10mA @ 24VDC
Operating Voltage:	14 to 28VDC
IP Rating:	IP54
Operating Temp:	-20 to +55°C
Humidity:	93% RH (non condensing) max

The system can be fully customised, according to local conditions; both alarm thresholds (sensitivity) and time to Alarm/Fault can be set from the ground level System Controller.

Each detector head is independently configurable from 8m through to 100m and has its own individual fire threshold. The System Controller retains one set of Fire and Fault relays that is common to all detectors that are installed.

The FR5000 MultiHead is supplied with one detector head and reflector for single beam operation from 8 to 50 meters. Up to 3 additional detector heads can be added to the controller to enable larger or more complex areas to be protected (Subject to local codes and standards).

The Fireray 5000 when used in its low power mode can be interfaced to the MZX Fire Controller using the BDM800 module.

Product Codes

516.015.020	FireRay 5000 System (50m)
516.015.021	FR 5000 Detector Head (50m)
516.015.007	FireRay Reflector 100 x 100mm
	4 reflectors are required for distances from 50 to 100m



Features

- Separate Transmitter and Receiver Heads
- Range 5 to 120 metres, configurable per set of Detectors
- Integral Laser Alignment in Receiver
- 2-wire Interface between Controller and Receiver
- Single and Twin Detector options
- Separate Fire and Fault Relays per Detector
- Low Level Controller with LCD display
- Programmable Sensitivity and Fire Threshold
- Automatic Gain Control (AGC) for drift compensation
- First Fix concept for Transmitter, Receiver and Controller
- Multiple cable gland knockouts for ease of wiring
- Optional Transmitter powering from Controller

Fireray® 3000 Optical Beam Smoke Detector

The FIRERAY® 3000 is ideal for applications where line of sight for the IR (infra-red) detection path is narrow and where the building structure uses reflective surfaces. It has also been designed to be aesthetically pleasing and thus can equally suit modern architectural buildings as well as heritage sites, particularly where ornate ceilings exist.

The FIRERAY® 3000 has been designed so that it can be installed by one operator, with its laser assisted alignment method combined with easy to use alignment LED's offering visual feedback. The integrated laser alignment aid can be activated at the controller or at the receiver head.

An additional detector head set (one transmitter & one receiver) can be added to the controller, separate relay contacts are provided for each of the 2 beam sets.

Technical Specification

Dimensions & Weight

Control Unit: 203 x 124 x 71.5mm (W x H x D)
606gms

Transmitter & Receiver: 78 x 77 x 161mm (W x H x D)
207gms

Operating Range: 5 to 120 m

Operating Voltage Range: 12 to 36V DC $\pm 10\%$

Operating Controller Current (with 1 or 2 Receivers): 14mA (constant)

Operating Transmitter Current: 8mA (per transmitter)

Power Down Reset Time: >10 seconds

Fire and Fault Relay Contacts: VFCO 2A @ 30Volts DC resistive

Operating Temp. (non-condensing):

UL - -20°C to +55°C

EN54 - -10°C to +55°C

IP Rating: IP54

Relative Humidity (non-condensing): 93%

Product Codes

516.015.030 Fireray3000 Optical beam detector
516.015.031 FireRay3000 Extra beam set

FireRay Optical Beam Smoke Detector Mounting Accessories

There are a range of mounting accessories available for use with FireRay® Optical Beam Smoke Detectors. These accessories will help reduce installation times and provide a professional mounting solution when faced with challenging building internals.



The Universal Mounting bracket can be used with the Fireray 5000 detector head and the 1 or 4 way prism plates to enable the detector head or prism plates to be easily mounted and adjusted when fixing to angled walls or cladding



The large prism plate will securely mount 4 prisms and is designed to be used in conjunction with the Universal Mounting Bracket (not included)



The Flat Mounting plate is a metal plate which will support a single prism or 4 prisms, the side mounting holes are compatible with Unistrut® racking systems.



The small prism plate will securely mount a single prism and is designed to be used in conjunction with the Universal Mounting Bracket (not included)



Adjustable bracket for use with the Fireray 3000 heads or Fireray 5000 head.

Product Codes

5000-005 Universal Mounting Bracket
5000-006 Flat Mounting Plate for 1 to 4 Prisms
5000-007 Prism Mounting Plate for 4 Prisms
5000-008 Prism Mounting Plate for 1 Prism
3000-201 FireRay3000 adjustable bracket

Linear Heat Detectors



Features

- Easy and cost effective installation
- Good sensitivity with adjustable alarm threshold
- Open and short circuit monitoring
- Suited for outdoor and indoor applications
- Can be used in hazardous areas
- Mechanical protection is provided for cables in areas where damage may occur
- Chemical resistance sheathing is available for areas where petro-chemical corrosion may occur.

Linear Heat Detection

The LD40 linear heat detection system is used to monitor fire (or overheat) conditions in confined or polluted areas or where there are adverse or unusually variable environmental conditions.

The sensor cable is unaffected by dust, moisture or vibration and requires little maintenance.

Technical Specification

Dimensions:	178H x 130W x 75D mm
Weight:	0.55Kg
Operating Temp:	-25°C to +70°C
Relative humidity:	Up to 98% RH non-condensing
Rating:	IP55
Operating Voltage:	+8 to +30Vdc
Quiescent Current:	60-80µA

Product Codes

516.016.005	LD40 High resistance sensor cable blue - 200M reel
516.016.006	LD40 High resistance sensor cable black - 200M reel (Nylon sheath suitable for petrochemical exposure)
516.016.010	LD40 EOL Termination kit (PK10)
516.016.011	LD40 In-line Jointing kit (PK10)
516.016.012	LD40 Analyser module with conventional detection zone interface
516.016.201	B6782-003 EDGE CLIP 2-3mm WEB
516.016.202	B6782-024 EDGE CLIP 3-8mm WEB
516.016.203	B6782-025 EDGE CLIP 8-13mm WEB
516.016.204	B6782-026 EDGE CLIP 14-20mm WEB
516.016.205	B6782-004 'T' CLIP
516.016.206	B6782-005 PIPE CLIP
516.016.207	B6782-023 'V' CLIP
516.016.208	B6782-008 NEOPRENE SLEEVE



Ceiling Clip



Edge Clip



Pipe Clip



V Clip

Standard Detector Bases

To complement the new 850 range and 830 range of detectors, a number of bases and detector accessories are available. They are designed to further enhance the installability and serviceability of the range with an emphasis on reducing engineering costs. The detector bases are designed to snap-fit to the ceiling tile adaptor or can be screw fixed to a ceiling or electrical box in the traditional manner. A park position allows the detector to be mechanically attached to the base without making electrical connection to facilitate the testing of electronic free bases.

4B-C 4" Continuity Base



The new 4B-C 4" continuity base is designed to snap-fit to the ceiling tile adaptor or it can screw fix to a ceiling in the traditional manner. The 4B-C 4" continuity base is designed specifically for use with the 850 series detector and provides a switching mechanism that ensures continuity when the detector (and built-in short circuit isolator) is removed. When used with the time saver ceiling tile adaptor, the 4B-C 4" continuity base uses a snap-fit mechanism that saves installation time.

Features

- For use with the 850 series detectors
- Compact rigid design that improves the appearance and is easy to install
- Built-in continuity switch that closes on detector removal
- Electronics free, permits in circuit testing
- Snap fit to the time saver ceiling tile adaptor
- Detector locking pin included
- Detector park position for service and commissioning, holds the detector mechanically in place whilst disconnected from the loop and continuity switch is closed
- Choice of 8 mini-trunking break-outs

Product Code

517.050.042
4B-C 4" Continuity Base

4B 4" Detector Base



The new 4B 4" detector base is designed to snap-fit to the ceiling tile adaptor or it can be screw fixed to a ceiling in the traditional manner.

Features

- Compatible with 830 series detectors
- Drives a remote indicator
- Detector locking pin provided with every base
- Snap fits to the Time Saver Ceiling Tile Adaptor
- Fits directly to a British or European electrical back box
- Temporary park position
- Break-outs for surface mount

Product Code

517.050.041
4B 4" Detector Base

4B-I 4" Isolator Base



The new 4B-I 4" Isolator base is designed to snap-fit to the ceiling tile adaptor or it can screw fix to a ceiling in the traditional manner. The 4B-I 4" base is designed specifically for use with the 830 series detectors and provides protection against short circuit faults on the MZX digital addressable loop.

Features

- For use with the 830 series detectors
- Compact rigid design that improves the appearance and is easy to install
- Up to 250 x 4B-I 4" isolators can be connected on each loop
- Snap fit to the time saver ceiling tile adaptor
- Detector locking pin included
- Detector park position for service and commissioning, holds the detector mechanically in place whilst disconnected from the loop
- Choice of 8 mini-trunking break-outs

Product Code

517.050.043
4B-I 4" Isolator Base

Chapter 2 - MZX Technology

Ceiling Tile Adaptor



The Time Saver Ceiling Tile Adaptor is used with the 4" snap fit base and consists of three parts, a bezel and clamp that are fitted to the ceiling tile and a back-box that carries the detector and base assembly. It is available as a complete unit or alternatively, the back-box can be ordered separately, as can the bezel and clamp assembly. Ordering the parts separately may be preferred if there is an extended period before the false ceiling is installed e.g. "shell and core" projects. Requires a 127mm diameter hole. The CTA adaptor plate allows the Time Saver Ceiling Tile Adaptor to be used with other devices such as the AV Base, 802SB or Mini Firecryer.

Features

- Cuts installation time by 30%
- Commission the system before the suspended ceiling is installed
- Suitable for ceiling tiles from 1mm to 30mm thick
- Made from flame retardant material
- No additional back-box is required
- Time saver is designed for use with a new snap-fit 4" detector base
- Adaptor available for use with the AV base & other devices

Product Codes

[517.050.060](#)
Ceiling Tile Adaptor Kit consists of 1 x [517.050.056](#) and 1 x [517.050.057](#)
[517.050.056](#)
CTA-BB CTA Back Box
[517.050.057](#)
CTA-BC CTA Bezel and Clamp
[517.050.058](#)
CTA-AP CTA Adaptor Plate

4B-6A 4" to 6" Adaptor



The 4B-6A 4" to 6" Adaptor is designed for use with U.S. style 6" electrical back boxes and provides a flush architectural trim between the electrical box and the 4B-C 4" continuity base. It can also be fixed directly to a ceiling and used to conceal marks left when older, large diameter detectors are replaced with MZX Technology.

Features

- Adapts 6" electrical boxes to fit the 4B-C 4" continuity base
- Architectural trim for neat appearance
- Concealed fixings
- Use to conceal marks left by old detectors when replaced by MZX Technology

Product Code

[517.050.054](#)
4B-6A 4" to 6" Base Adaptor

Functional Detector Bases

The range of standard bases is supplemented by this selection of sounder bases, relay bases and accessories, including loop powered sounder bases for use on MX technology controllers. In addition, changes to the building during its life can be easily adapted to, by retrofitting sounders and relay outputs to existing detection points.

When functional bases are fitted to universal bases, they automatically lock into position. Removal is then achieved using the detector removal tool. This feature ensures that the detector and functional bases are removed separately.

Tyco MKII Sounder Base



A new low current range of sounder bases for use with Conventional and Addressable Fire Alarm Control Panels.

Features

- Manufactured to EN54 part 3
- Integral sounder and detector base
- Volume and tone adjustable after installation
- Low Power Synchronisation
- Do not require use of a standard base (maybe installed directly onto a standard besa box)

Product Codes

516.800.911
901SB Universal Sounder Base
516.800.910
802SB MX Loop Powered Sounder Base
516.800.913
812SB MX Loop Powered UL Sounder Base
516.800.912
912SB Universal UL Sounder Base
517.050.022
Volume Pot Spare Cover (1 sheet of 144)
517.050.005
4" Detector Base Locking Pin Kit (PK100)

SAB 801 Sounder Addressable Beacon



The SAB 801 Sounder Addressable Beacon is an MX Addressable Beacon that fits into the Standard Minerva Universal Base. Alternatively the SAB may be fitted to the 802SB, 812SB, 901SB and 912SB Sounder Bases to enable the MX Control Panel to communicate with and control these sounder bases and also provide a Flashing Beacon effectively turning the 802SB, 812SB, 901SB and 912SB into a combined addressable loop powered sounder and beacon.

The SAB is suitable for wall or ceiling mounting. Sound selection and tones will be as per the 802SB, 812SB, 901SB and 912SB.

Product Code

516.800.956
SAB 801 Low Power Sounder Addressable Beacon (Compatible with Consys Version 8.1 and above)

801RB - Functional Relay Base



The 801RB provides dual relay contacts for signalling external devices on MX addressable systems. A very low operating current even when the relay is energised enables the relay base to be used without any additional power. The dual contacts are under the control of a programmable output, through the powerful cause and effect software.

Features

- Dual pole 24V DC relay contact (60VA)
- Very low power consumption (<20µA except startup)

Product Code

516.800.905
801RB Relay base

Volume Adjustment Tool



A simple Volume Adjustment Tool, specific to the task of sounder volume selection on the "variable-volume" range of Tyco MKII Sounder Bases.

Sounder volume can be easily varied between the maximum 90dBA and minimum 68dBA-volume settings, using this simple, functional tool.

Product Code

517.050.015
Volume Adjustment Tool

Note: Sounder Bases are supplied with the volume pre-set to maximum volume.

Detector Base Ancillaries

801RIL - Remote Indication LED



All detector bases have the ability to drive a remote LED in the event that the installed position of the detector is not easily visible. The 801RIL is primarily designed for LPCB influenced markets but is compatible with all 800 Series detectors.

Features

- UK Single gang mounting
- High intensity red LED

Product Code

516.800.908
801RIL remote indication LED

800HL - Indication Lamp

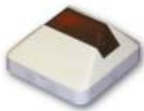

The 800HL remote indicator lamp provides a larger indicator for use in place of the RIL when longer distances are involved or in VdS influenced markets. Typically used to indicate the source of an alarm in buildings with long corridors eg. Hotels, hospitals, apartments.

Product Code

516.800.909
800HL indication lamp

4B-EM 4" Euro Mount



The euro-mounting base provides a matching back box, which allows the 4" bases to be ceiling mounted with conduit entries for standard 18 and 21mm conduit.

Features

- 2 x 18mm conduit entries
- 2 x 21mm conduit entries
- Fits all 4" Bases
- Accepts up to 8 accessory terminals

Product Codes

517.050.052
4B-EM 4" Euro Mount
517.050.612
Base Accessory terminal kit
(pack of 10)

4B-DHM Deck Head Mounting



Where the detectors are mounted in humid and environmentally challenging situations such as marine or offshore installations, the 4B-DHM deck head mount provides a sealed waterproof mounting which protects the electrical connections in the base. Can be screwed, bolted / welded to the deckhead. Supplied with 1 terminal. If more are required, use the optional base accessory terminal kit.

Features

- 4 x 20mm gland entries
- Fits ALL 4" bases
- IP55 with supplied gasket

Product Codes

517.050.051
4B-DHM Deckhead Mount
517.050.612
Base accessory terminal kit
(pack of 10)

Protective Detector Cage



Robust steel protective cage for Series 800 detector ranges using the 5" bases. Ideal for schools and sporthalls or whenever detectors need protection.

Strong coated steel construction with 4 point fitting.

Product Code

517.050.614
CW-5B Detector Cage

Protective Detector Sounder Base Cage



White powder coated steel protective cage for Series 800 Detectors fitted with a sounder base. Internal dimensions: 120mm dia x 80mm deep.

Product Code

517.050.011
Steel Protective Detector Cage

Detector Ancillaries



800 Series MX Address Flag

The 800 Series detectors incorporate a feature, which automatically transfers the address flag to the detector base, when the detector is plugged into the base. On removal of the detector the address flag remains on the ceiling, thus ensuring that detectors are not accidentally returned to the wrong detector base following service routines. Most MX detection panels incorporate additional fail

Features

- Provides clear identification of address
- Colour coded
- Flag remains on base

Product Codes

516.800.915	MX Address flags (pack of 100)
516.800.931	Address flag labels Loop A - White
516.800.932	Address flag labels Loop B - Yellow
516.800.933	Address flag labels Loop C - Purple
516.800.934	Address flag labels Loop D - Green

safe software features to ensure that incorrect detector positioning does not compromise the system. Address flags are supplied in packs of 100. Labels are provided on sheets of 250 in eight colours to enable quick identification between different loops.

516.800.935	Address flag labels Loop E - Grey
516.800.936	Address flag labels Loop F - Blue
516.800.937	Address flag labels Loop G - Orange
516.800.938	Address flag labels Loop H - Red



Features

- Colour coded for Easy Loop Identification
- Space for Zonal Label
- Strong Adhesive Backing

Callpoint & Ancillary Address Labels

Detectors have a special address flag for carrying the address labels - detailed in the detector section. For other devices or on detectors where zone information is also required a series of address labels are available.

Numbered 1 to 250, the address labels are available in 8 different colours to distinguish between different loops. In addition small zone labels can be fixed to the address labels.

Product Codes

<i>Zone Labels</i>	
599.047.011	Zone labels - Zones 1 - 16
599.047.012	Zone labels - Zones 17 - 32
599.047.013	Zone labels - Zones 33 - 48
599.047.014	Zone labels - Zones 49 - 64
599.047.015	Zone labels - Zones 65 - 80
599.047.016	Zone labels - Zones 81 - 100
599.047.018	Zone labels - Zones 101 - 120
599.047.019	Zone labels - Zones 121 - 140
599.047.020	Zone labels - Zones 141 - 160
599.047.021	Zone labels - Zones 161 - 180
599.047.022	Zone labels - Zones 181 - 200

599.047.023	Zone labels - Zones 201 - 220
599.047.024	Zone labels - Zones 221 - 240

Address Labels

599.047.030	Address Labels 1 - 250 Loop A - White
599.047.031	Address Labels 1 - 250 Loop B - Yellow
599.047.032	Address Labels 1 - 250 Loop C - Purple
599.047.033	Address Labels 1 - 250 Loop D - Green
599.047.005	Address Labels 1 - 127 Loop E - Grey
599.047.006	Address Labels 1 - 127 Loop F - Blue
599.047.007	Address Labels 1 - 127 Loop G - Orange
599.047.008	Address Labels 1 - 127 Loop H - Red

Duct Probe Air Sampling

Where smoke within duct work needs to be detected these duct probe units provide an economical solution, for use with 800 series detectors.

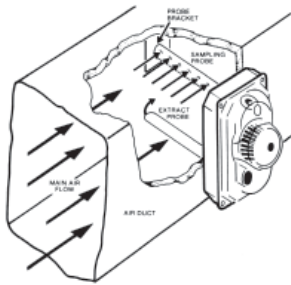

SMP Duct Probe Units

The SMP Duct Probe Units are designed to be installed in air conditioning supply and exhaust ducts for the purpose of monitoring the airflow for smoke and combustion products.

The SMP69 probe units are designed to accept and operate with the 800 series detectors. For general applications it is recommended that photoelectric smoke detectors rather than ionisation smoke detectors are used.

The SMP stainless steel probe unit is designed to withstand the more demanding environments of the offshore oil and gas industries.

The units are designed to operate in airspeeds of 1.5 to 25 metres per second. A range of sampling tubes from 525mm to 1575mm are available.

Warning

Duct probe units sited in the common duct work to several extract grills may fail to respond to smoke from any one extract due to the effect of dilution. The SMP units will not respond to airflow of less than 1.5m/sec.

SMP69
Height 90mm
Width 150mm
Length 225mm
Weight 1.2Kg

Technical Specification

Operating temperature:	-20°C to + 70°C
Storage temperature:	-25°C to + 80°C
Relative Humidity:	0 to 95%
SMP69	Stainless steel 316 housing with transparent polycarbonate cover

SMP69 Duct Probe Air Sampling - Stainless Steel



Product Codes

517.025.035

SMP69 Stainless Steel Duct Probe unit and universal detector base for Series 600/800 Detectors.

517.025.028

DPS450 Probe tube stainless steel 450mm and exhaust

517.025.029

DPS600 Probe tube stainless steel 600mm and exhaust

517.025.030

DPS750 Probe tube stainless steel 750mm and exhaust

517.025.031

DPS900 Probe tube stainless steel 900mm and exhaust

577.025.032

DPS1200 Probe tube Stainless Steel 1200mm and exhaust

517.025.033

DPS1500 Probe tube stainless steel 1500mm and exhaust

Datasheet - Product Code PSF92 "SMP69 Duct Probe Unit"

Manual - Vol 01B-06-D1 "Detectors Fire Manual"



DPK4 Duct Probe

The DPK4 and DPK4I duct probe units have been developed to detect smoke in ventilation ducts. They offer significant benefits in terms of performance and installation. The system comprises a single duct probe tube and housing specially designed for optimum airflow through the smoke detector and suitable for use in incoming, outgoing and circulation air ducts of ventilation and conditioning systems.

The duct probes can operate across a wide range of airflow speeds and are especially recommended for installations in ducts with air flow velocities between 1 m/s and 20 m/s.

Unlike more traditional duct probe units that employ an inlet and exhaust tube with sampling holes, the DPK4 and DPK4I units use a highly efficient single sampling tube that is slotted along its length. This allows the sampling tubes to be cut to the desired length whilst maintaining maximum efficiency.

Features

- Built-in MZX Detector base
 - DPK4 - with built-in MZX detector base 5" - 5B
 - DPK4I - with built-in MZX detector base 5" - 5BI
- DPK4 is suitable for addressable and conventional systems
- DPK4I with built-in line isolator for use with MZX Technology® systems
- Suitable for air velocities from 1 m/s to 20 m/s
- Can be used in combination with a wide range of optical smoke detectors e.g. 801PH, 813P, 601P or 601PH
- One-pipe air sampling system simplifies installation
- Range of aluminium probe tubes are available for ducts up to 2700 mm
- Transparent lid allows detector to be seen
- Test hole on cover
- Sensitive flow indicator
- Simple service and maintenance
- Installer friendly connection of cables
- Easy installation of duct probe tubes

The transparent cover gives clear visibility of the detector, its LED indication and airflow indicator. A red plastic flag is fixed inside the housing providing a simple but effective confirmation that there is no leakage and that the air flow from the air duct is in fact passing through the housing.

In order to reduce the time required to test the duct probe detector during routine maintenance, an aperture is provided that allows aerosol test gas to be directed at the detector without having to dismantle the unit.

Accessories

Tyco Fire Protection Products offers 3 lengths of the duct probe tubes. The tube is made of aluminium and can easily be shortened to suit the span of the air duct. Where the unit is mounted on insulated or circular air ducts, the DPKM mounting bracket is required.

Product Codes

517.025.049	DPK4 - Duct Probe with MZX detector base 5" - 5B
517.025.050	DPK4I - Duct Probe with MZX detector base 5" with isolator - 5BI
517.025.051	DPK600 - Duct Probe Tube 600 mm
517.025.052	DPK1500 - Duct Probe Tube 1500 mm
517.025.053	DPK2800 - Duct Probe Tube 2800 mm
517.025.054	DPKM - Duct Probe Mounting Bracket
517.025.055	Spare Filters for DPK4/DPK4I (PK of 10)

Detector supplied separately

MX Addressable Input/Output Modules

APM800 Addressable Power Supply Monitor



The APM800 is an MX addressable power supply monitoring module which is usually used with the PSM800/820/821 power supply module to make an addressable power supply. The APM800 is designed to fix to studs on the top of the PSM800/820/821. The APM800 monitors the PSM800/820/821 for mains failure, earth fault, battery charger fault and battery fault. It can reset the PSM800/820/821 resettable 24Vdc output and initiate a battery test which then reports a battery voltage and current to the controller.

Technical Specification

EMC/RFI: Equal or exceeds EN50081- 1 & EN50130-4
 Operating Temp.: -25°C to +70°C
 Relative Humidity: up to 95% RH non-condensing
 Dimensions: 24H x 127W x 57D mm
 Weight: 0.794Kg

Product Code

557.202.027
 APM800 addressable power supply monitor

MIM800 Mini-Input Module



The MIM800 is a small MX addressable module designed for monitoring a single input circuit. The MIM800 can monitor normally open or normally closed inputs and provides open and short circuit monitoring of the line. The MIM800 is designed for fitting in small devices such as flow switches, special detection devices and explosion proof callpoints. A variant of the MIM800 is used in all callpoints and pullstations.

Technical Specification

EMC/RFI: Equal or exceeds EN50081- 1 & EN50130-4
 Operating Temp.: -25°C to +70°C
 Relative Humidity: up to 95% RH non-condensing
 Dimensions: 13H x 48W x 57D mm
 Weight: 100g
 EOL Resistor: 200 Ohm
 Monitor Resistor: 100 Ohm

Product Code

555.800.001
 MIM800 mini-input module

CIM800 Contact Input Module



The CIM800 is a flexible addressable input-monitoring device that fits in the standard ancillary housings. The CIM800 provides two inputs to current MX panels though this can be implemented as two separately wired spurs (Style B) or as a loop (Style A). Both spur and loop input wiring can be configured to monitor normally open or normally closed inputs. In addition both can be configured to initiate an alarm or short circuit fault message in the event of a short circuit on normally open monitoring circuits.

Technical Specification

EMC/RFI: Equal or exceeds EN50081-1 & EN50130-4
 Operating Temp.: -25°C to +70°C
 Relative Humidity: up to 95% RH non-condensing
 Dimensions: 14H x 148W x 87D mm
 Weight: 100g
 EOL & monitor resistor: 10k Ohms

Product Codes

555.800.002
 CIM800 contact input monitor
 555.800.032
 CIM800 Module c/w Front Cover

DIM800 Detector Input Module



The DIM800 is designed to power and monitor a circuit of low voltage conventional detectors and callpoints. The detection circuit is powered from an external 24V d.c. supply and is reset by the MX addressable panel. The DIM800 monitors the external 24V d.c. and provides a fault signal if it is lost. The input detection circuit can be wired as one or two spur circuits (Class B), one loop configured circuit (Class A) or one 4 wire detection circuit. The DIM800 is designed to be compatible with most conventional detection products. Compatibility has been tested to date on the following products: Compatible Thorn detectors: M300 Series, M601 Series, S100 Series, H Series, S231F, S231F+ & CP200.

Technical Specification

EMC/RFI: Equal or exceeds EN50081- 1 & EN50130-4
 Operating Temp.: -25°C to +70°C
 Relative Humidity: up to 95% RH non-condensing
 Dimensions: 14H x 148W x 87D mm
 Weight: 100g

Product Codes

555.800.012
 DIM800 detector input monitor
 555.800.042
 DIM800 Module c/w front cover

LIM800 Line Isolator Module



The LIM800 Ancillary Line Isolator Module is designed to be used on all MX addressable loops. It monitors the line condition and upon detection of a short circuit it isolates the affected section whilst allowing the rest of the addressable loop to function normally. The LIM800 Ancillary Line Isolator Module ensures that on a looped addressable system a short circuit fault cannot disable more detection devices than would be lost on a conventional non-addressable system in accordance with BS5839 Part 1.

Technical Specification

EMC/RFI: Equal or exceeds EN61000-6-3 & EN50130-4
 Operating Temperature: -25°C to +70°C
 Relative Humidity: Up to 95% RH non-condensing
 Dimensions: 14H x 148W x 87D mm
 Weight: 100g

Product Codes

545.800.004
 LIM800 Ancillary Line Isolator Module
 545.800.033
 LIM800 Ancillary Line Isolator Module c/w front cover

TM520 Timer Module



The TM520 provides 2 x outputs that can be activated based on a delay time. If either the key-switch on the module is activated, or a predefined event within the control panel occurs then a timed delay (set between 10 minutes and 2 hours 10 minutes) is started. When the delay reaches zero the TM520 outputs are activated. The unit sounds an internal buzzer and illuminates a red LED when the

outputs are active, and illuminates a yellow LED when the timer is counting down. To provide a warning that the delay is nearly over, the red LED and the buzzer will pulse 5 minutes before the end of the delay. The TM520 requires a separate 24V DC supply to operate. The module is not addressable and will therefore not take an address on the loop.

Technical Specification

Powered: 24Vdc
 Temperature Range: -20°C to +70°C
 Operating Humidity: <95% RH
 Dimensions: 87H x 148W x 14D mm

Product Code

557.180.423
 TM520 timer module - non addressable

SIO800 Single Input/Output Module



The SIO800 Single Input/Output Module is designed to provide a monitored input and a volt free relay changeover output. It consists of an input for monitoring the status of a normally open contact and a single changeover relay contact. The relay is controlled by a command sent from the Minerva MX Fire Controller via the addressable loop.

The state of the relay (activated, deactivated or stuck) is reported to the Minerva MX Fire Controller. The LED may be turned ON or OFF by the controller during a relay activated condition.

Technical Specification

EMC/RFI: Product Family standard EN50130-4 in respect of Conducted Disturbances, Radiated Immunity, Electrostatic Discharge, Fast Transients and Slow High Energy. 61000-6-3 for Emissions.
 Operating Temperature: -25°C to +70°C
 Relative Humidity: Up to 95% RH non-condensing
 Dimensions: 14H x 148W x 87D mm
 Weight: 105g

Product Codes

555.800.063
 SIO800 Single Input/Output Module
 555.800.064
 SIO800 Single Input/Output Module c/w Front Cover

DDM800 Universal Fire and Gas Module



The DDM800 provides the ability to connect and interface 2 zones of conventional 2 wire fire detectors or two 4-20mA sensors to the MX Fire alarm controllers.

When used to interface conventional detection devices, Open & Short circuit and device removal monitoring is provided. Intrinsically safe (IS) detection is supported when used with a galvanic isolator. An integral line isolator is incorporated in the module. Loop powered or 24vdc operation. The 4-20mA interface can be used to monitor devices such as gas detectors, temperature alarms or any 4-20mA interfaced device. Compatible with MXConsys version 15 or later.

Technical Specification

EMC/RFI: Equal or exceeds EN61000-6-3 & EN50130-4
 Operating Temperature: -25°C to +70°C
 Operating Humidity: Up to 95% RH non-condensing

Product Codes

577.800.006
 DDM800 Universal Fire and Gas Module
 577.800.036
 DDM800 Universal Fire and Gas Module c/w front cover
 577.800.056
 DDM800 Universal Fire and Gas Module housed in IP55 D800 Enclosure
 557.800.057
 DDM800 Detector Removal End of Line Resistor (pack of 10)

Chapter 2 - MZX Technology

RIM800 Relay Interface Module



The RIM800 provides a single programmable relay output from the MX DIGITAL addressable loop which can be programmed for a variety of applications including signalling fire conditions to plant, machinery, fire doors, dampers & security systems. The RIM800 relay coil is monitored. The RIM800 relay contact is rated for 2A @ 24V d.c. but can be used to switch mains voltage when used with the HVR800. This unit has two opto-isolated terminals specifically for driving the HVR800.

Technical Specification

EMC/RFI: Equal or exceeds EN61000.6.3 & EN50130-4

Operating Temp.: -25°C to +70°C

Relative Humidity: up to 95% RH non -condensing

Dimensions: 14H x 148W x 87D mm

Weight: 100g

Quiescent Current: 200µA

Relay contacts: 2A @ 24V d.c.

Product Codes

568.800.003
RIM800 relay interface module
568.800.033
RIM800 Module C/W Front Cover

HVR800 High Voltage Relay Module



The HVR800 module is a non-addressable device which allows a low current mains rated relay to switch up to 10A. Alternatively a low voltage drive signal such as that provided by the RIM800 or 80 way mimic can be used to switch the integral mains relay via the opto-isolated input.

Technical Specification

EMC/RFI: Equal or exceeds EN61000.6.3 & EN50130-4

Operating Temp.: -25°C to +70°C

Relative Humidity: up to 95% RH non-condensing

Dimensions: 26.5H x 42W x 74D mm

Relay Contacts: Up to 10A @ 250Va.c.

Product Codes

568.800.004
HVR800 high voltage relay
568.800.034
HVR800 in isolated D800 housing

SNM800 Sounder Notification Module



The SNM800 is a remote addressable sounder circuit output device capable of switching sounder and speaker circuits up to 2A @ 24V d.c. or provide a monitored output facility for other applications. These can be used in addition to the two circuits provided as standard on most MX detection panels. The SNM800 can support sounder circuits wired as a spur (Class B – Style Y) or in a loop configuration (Class A – Style Z). The SNM800 can be configured with a RIM800 to provide a secure monitored extinguishing release solenoid control.

Technical Specification

EMC/RFI: Equal or exceeds EN61000.6.3 & EN50130-4

Operating Temp.: -25°C to +70°C

Relative Humidity: up to 95% RH non-condensing

Dimensions: 14H x 148W x 87D mm

Weight: 100g

Output rating: 2A @ 24V d.c.

EOL resistor: 27k 1/2W

Product Codes

577.800.005
SNM800 sounder notification module
577.800.035
SNM800 Module c/w Front cover

LPS800 Loop Powered Sounder Module



The LPS800 provides a single monitored sounder output circuit with up to 75mA of power sourced from the MX panel.

Technical Specification

EMC/RFI: Equal or exceeds EN61000.6.31 & EN50130-4

Operating Temp: -25°C to +70°C

Relative Humidity: up to 95% RH

Dimensions: non- condensing 14H x 148W x 87D mm

Weight: 100g

Output rating: 75mA @ 24V d.c. max

Product Codes

577.800.011
LPS800 Loop Powered Sounder module
577.800.041
LPS800 Module c/w front cover

NOTE: Each MX Digital Loop can provide up to 495mA for loop powered sounders and modules

SB520 Sounder Booster Module



The SB520 sounder booster module enables the SNM800 to drive circuits with higher currents whilst maintaining the reverse polarity integrity line monitoring.

Technical Specification

EMC/RFI: Equal or exceeds EN61000.6.31 & EN50130-4

Operating Temp: -25°C to +70°C

Relative Humidity: up to 95% RH non--condensing

Dimensions: 14H x 148W x 87D mm

Weight: 100g

Output rating: 15A @ 24V d.c./10A Max. per terminal
Non addressable

Product Codes

577.001.023
SB520 Sounder Booster Module
577.001.033
SB520 Module c/w Front Cover

BDM800 Beam Detector Module - Loop Powered



The BDM800 Beam Detector Module is designed to interface the FIRERAY 50R or the 100R reflective beam detector to the MX Digital Addressable Loop. The BDM800 provides power from the loop, monitors the Fire and Fault outputs of the detector and also monitors inter-connections for open and short circuit faults. The BDM800 can also be used with the FIRERAY 2000 active infrared beam detector. Supplied fitted in a standard double gang ancillary housing, the BDM800 greatly simplifies the wiring normally associated with beam detection.

The considerable cost of providing local power supplies that satisfy the stringent requirements of BS5839 part 1 is eliminated.

Features

- Power Beam detectors directly from the MX Digital loop
- Reduced wiring and installation costs
- Monitors beam detector for fire and fault
- Inter-connection monitored for open and short circuit faults
- LPCB and VdS approved (pending)
- Can be installed to BS5839 part 1

2002

- On board LED indicates polling and active
- Use with reflective beams FIRERAY 50R or 100R for greater savings on installation
- Compatible with FIRERAY 2000 + FIRERAY 5000 beam detectors
- Optional BTM800 beam termination module to further simplify installation

Product Code

555.800.066
BDM800 Beam
Detector Module c/w Cover

BTM Beam Termination Module



In many cases it will be necessary to site the BDM800 Beam Detector Module some distance from the beam detector itself. To minimise and simplify wiring in such cases an optional unit, the BTM800 beam termination module is available. The BTM800 is also housed in a standard double gang ancillary cover and has

all the connections and components required to minimise installation time.

Features

- Simplifies the wiring between Beam detector and BDM800
- Allows BDM800 to be sited up to 40m from the beam detector

Product Code

555.800.067
BTM800 Beam Terminal Module c/w Cover

MIO800 Multi-Input Output Module



The MIO800 is a general purpose interface module for use with MX technology™ fire detection systems. It allows multiple input and output connections to be made between external equipment and the MX Digital loop. Three input and four outputs are provided. Each input and output can be programmed independently using the MX Consys configuration tool to provide customised functionality.

An IP55 rated D800 style housing is used as the standard enclosure with the option of a DIN-rail mounting kit for in-cabinet installations.

Features

- Normally open or normally closed inputs
- Inputs monitored for open or short circuit faults.
- STYLE B (short circuit gives an alarm) or STYLE C (short circuit gives a fault) selectable for inputs
- Provides four digital outputs
- All four outputs can drive a self-powered high voltage relay HVR800
- Two outputs have both volt free change over contacts and HVR Drivers.

Technical Specification

Operating Temperature:
-25°C to + 70°C
Storage Temperature:

-40°C to +80°C
Operating Humidity:
Up to 95% non-condensing
Dimensions (HWD):
Module 72 x 110 x 18mm
Boxed 124.5 x 166.5 x 84.5mm
Weight: Module 70g
Boxed 271g
Relay Contact Rating:
DC - 2A @ 24V dc

Product Codes

555.800.065
Multi I/O Module
557.201.401
D800 Ancillary Housing
557.201.303
Din Rail Mounting Kit

TSM800 Door Control Module



The TSM800 is used to control fire doors in accordance with BS2723 Part 4. When activated, either by a fire signal or by a fault or isolation within the fire door zone, the TSM800 will interrupt the supply to the door holders and the doors under control of the module will close. The module has the provision to monitor a contact to report to the fire controller if the door fails to close. The module also includes a built-in line isolator.

This module requires MX Consys 10 or later to function.

Technical Specification

EMC/RFI: Equal or exceeds EN61000.6.3 & EN50130-4
Operating Temp: -25°C to +70°C
Relative Humidity: up to 95% RH non-condensing
Dimensions: 14H x 148W x 87D mm
Weight: 100g
Relay contacts: 2A @30VDC

Product Code

555.800.069
TSM800 PCB

VIO800 MX Vesda Interface



The VIO800 MX Vesda Interface will enable all versions of the popular LaserPLUS Detectors and 7 relay versions of the Laser SCANNER Detectors to be interfaced directly to the MXDigital detection loops. 3 configurable inputs and 1 output signal are available from the interface enabling it to integrate fully with the Vesda detector.

This module is designed to fit in bay one of the Vesda Detectors.

Product Code

516.018.014
VIO800 MX VESDA Interface

Chapter 2 - MZX Technology

Quad Input/Output Module (QIO850)



The Quad Input/Output Module connects directly to the MZX Digital loop and provides four change over relay outputs, four High Voltage Relay (HVR) outputs and four monitored inputs. It is loop powered and therefore does not need a power supply, however it can monitor the presence of a local 24Vdc or 48Vdc power supply.

Features

- Four change over relay outputs and four monitored inputs each individually programmable for a wide range of applications
- Four HVR drivers. No need for a local power supply to switch 240Vac mains
- Inputs can monitor normally open or normally closed contacts
- The relay contacts are monitored and users are alerted to "output stuck" conditions
- Uses 2 addresses when configured for 2 inputs with 2 associated outputs
- Uses 4 addresses when configured for 4 inputs with 4 associated outputs
- Uses 8 addresses when configured for 4 inputs and 4 independent outputs
- Compact DIN rail mount design saves space
- Lower installation costs than individual modules
- Built-in line isolators improve fault tolerance
- Status LED's provide rapid diagnostics
- Two way IR communication to the 850EMT programming tool speeds up commissioning
- Monitors input power supply for improved system integrity
- VdS and CPD approved to EN54-17, EN54-18 and EN54-13

Product Code

555.800.071
Quad Input/Output Module (QIO850)

Quad Monitored Output Module (QMO850)



The Quad Monitored Output Module connects directly to the MZX Digital loop and requires a 24Vdc or 48Vdc power supply. It provides four monitored outputs for connection to conventional sounder circuits or auxiliary relays.

Features

- Four polarity reversal monitored outputs
- Class A or Class B wiring for versatility
- Uses 2 addresses when configured for 2 outputs
- Uses 4 addresses when configured for 4 outputs
- Compact DIN rail mount design saves space
- Lower installation costs than individual modules
- Built-in line isolators improve fault tolerance
- Status LED's provide rapid diagnostics
- Two way IR communication to the 850EMT programming tool speeds up commissioning
- Monitors input power supply for improved system integrity
- VdS and CPD approved to EN54-17, EN54-18 and EN54-13

Product Code

555.800.070
Quad Monitored Output Module (QMO850)

Quad Relay Output Module (QRM850)



The Quad Relay Output Module connects directly to the MZX Digital loop and provides four change over relay outputs or four High Voltage Relay (HVR) outputs. It is loop powered and therefore does not need a power supply, however it can monitor the presence of a local 24Vdc or 48Vdc power supply.

Features

- Four change over relay outputs each individually programmable for a wide range of applications
- Four HVR drivers. No need for a local power supply to switch 240Vac mains
- The relay contacts are monitored and users are alerted to "output stuck" conditions
- Uses 2 addresses when configured for 2 outputs
- Uses 4 addresses when configured for 4 outputs
- Compact DIN rail mount design saves space
- Lower installation costs than individual modules
- Built-in line isolators improve fault tolerance
- Status LED's provide rapid diagnostics
- Two way IR communication to the 850EMT programming tool speeds up commissioning
- Monitors input power supply for improved system integrity
- VdS and CPD approved to EN54-17, EN54-18 and EN54-13

Product Code

555.800.073
Quad Relay Output Module (QRM850)

IP66 Housing for Quad I/O Modules



A polystyrene/polycarbonate IP66 rated housing prefitted with a din rail for mounting either 1 x Quad Input/Output Module (QIO850), or 1 x Quad Monitored Output Module (QMO850) or 1 x Quad Relay Output Module (QRM850) complete with a transparent front cover.

Features

- Ingress Protection rating of IP66
- Polystyrene/polycarbonate construction hence will not corrode
- Supplied prefitted with a din rail to enable the Quad Modules to snap fit into the housing
- Transparent front cover allows the status LEDs of the Quad Module to be viewed without removing the cover and also allows two way IR communication with the 850EMT programming tool
- Supplied with M20/M25/M32/M40 cable entry knockouts

Product Code

557.201.410
IP66 Housing for Quad I/O Modules

Chapter 2 - MZX Technology

Technical Specification

	QIO850	QMO850	QRM850	HOUSING FOR QUAD I/O MODULES
System Compatability	Any MZX Fire Alarm Controller configured with MZX Consys Version 20.0 or later			
Mechanical				
Dimensions (H x W x D)	103 x 134 x 49 mm			170 x 254 x 90 mm
Material				Grey Polystrene similar to RAL 7035 (Base). Transparent Polycarbonate (Cover).
Cable Entry Knockouts				24 x M20, 4 x M25/32, 4 x M32/40
Electrical				
Voltage	40VDC			
Current	1.1 mA (standby), 5.9 mA (alarm)	2.1 mA (standby), 6.7 mA (alarm)	1.1 mA (standby), 5.9 mA (alarm)	
Wire Size	0.5mm ² to 2.5mm ²			
Output Circuit (Relay Contacts)	Nominal switching capacity 2A at 30VDC (resistive load), Maximum switching power 60W, 125VA (resistive load)			
Auxiliary Voltage Input	Auxiliary voltage 24VDC to 55VDC (threshold voltage for auxiliary voltage fault indication: 18VDC +/- 1VDC). Auxiliary voltage 48VDC to 55VDC (threshold voltage for auxiliary voltage indication 36VDC +/- 2VDC).	Auxiliary voltage 24VDC to 55VDC (threshold voltage for auxiliary voltage fault indication: 18VDC +/- 1.5VDC). Auxiliary voltage 48VDC to 55VDC (threshold voltage for auxiliary voltage indication: 36VDC +/- 2.5VDC). Wiring monitoring (threshold resistance for auxiliary voltage fault indication 50 ohms +/- 5 ohms).	Auxiliary voltage 24VDC to 55VDC (threshold voltage for auxiliary voltage fault indication: 18VDC +/- 1VDC). Auxiliary voltage 48VDC to 55VDC (threshold voltage for auxiliary voltage indication 36VDC +/- 2VDC).	
Environmental				
Operating Temperature		-25°C to +7°C		-25°C to +40°C
Storage Temperature		40°C to +80°C		
Operating Humidity		Up to 95% Non condensing		100% at 25°C (SHORT TERM)
Ingress Protection	IP66			
Electromagnetic Compatability	EN50130-4 for immunity EN61000-6-3 for emissions			
Approvals	EN54-17, EN54-18 and EN54-13			



Features

- Connects directly to the MX Digital Loop.
- Reduced installation time and cost since no external module is required.
- Easier Programming and Commissioning – predefined in MXconsys.
- EN60950:2000 Compliant PSU.
- EN50130-4:1996 & EN50081-1:1992 Compliant PSU.
- Mains and Fault LED Indicator on front cover.
- Output fuse protected.
- 24VDC Voltage Door Release Relay.
- Specifically designed for the safe actuation of release mechanisms for doors.
- Satisfies the requirements of BS7273 Part 4 for category A actuation of Fire Doors.
- Built in line isolator.
- Self monitoring operation.
- Approved to EN54-18 (Input/Output Devices) and EN54-17 (Line Isolators).

MZX Compatible 4 Amp 24VDC Addressable Door Holder PSU

The MZX compatible ELM24TSM 4 Amp 24VDC Addressable Door Control & Power Supply Unit, is designed to provide monitoring and activation in compliance with the most stringent local door control standards.

This Door Holder PSU is interfaced to the MZX Panels via an integral TSM800 Door Control Module which is field mounted inside the Door Holder PSU and connects to the MZX Detector Loop.

Technical Specification

Input Voltage:	230VAC 50Hz
Output Voltage:	22 - 30Vdc
Output Current:	4 Amps Continuous
Temperature:	-10C to + 40C
Relative Humidity:	95% RH
IP Rating:	IP41 (excluding rear face)
Material:	1.2mm white powder coated steel
Dimensions:	230mm (W) x 200mm (H) x 80mm (D)

Product Code

558.004.011	ELM24TSM 4 Amp 24VDC Addressable Door Holder PSU
-------------	--

Housings

MX Ancillary Housings

A variety of ancillary housings are available to fit the 800 Series MX ancillaries. The standard sized modules are mechanically compatible with all options. LPCB approvals are with the M520 double gang cover plate or ancillary housings. The M520 double gang cover provides external access for the MX SERVICE TOOL to plug into the ancillary module which is mounted in the cover. All options allow the ancillary to be programmed and tested when the cover is removed.

M520



M520 Ancillary cover for use with 800 series modules. Will fit onto a MK style double gang back box.

Product Code

517.035.007
M520 Ancillary Cover

D800



D800 IP55 ancillary housing 140W x 120H x 70mmD incorporates window to view module LED

Product Code

557.201.401
D800 IP55 Ancillary Housing

ANC-3 Ancillary Housing



ANC-3 MINERVA ancillary housing - for use with M800 ancillary modules (can accommodate up to 3 M800 modules). 340W x 290H x 90mm D

Product Code

557.180.097.A
ADT Branded

ANC-8 Ancillary Housing



ANC-8 MINERVA ancillary housing - for use with M800 ancillary modules, houses 8 modules, expandable to 16 using the STK8 stacking kit. 440W x 320H x 140mm D

Product Codes

557.180.096.A
ADT Branded
557.180.095
STK8 stacking kit

DIN Rail Mounting Bracket



DIN Rail mounting bracket enables any module which can be mounted to a M520 ancillary cover to be DIN rail mounted using this bracket. Clip-on PCB mounting pillars are included. Will fit standard 35mm DIN Rail bracket.

Product Code

547.004.002
DIN rail mounting bracket

Chapter 2 - MZX Technology

QFB/2



QFB/2 Dry lining flush mount (for plasterboard etc) MK backbox for use with 800 Series addressable ancillaries using 517.035.007 cover.

Product Code

517.035.015
QFB/2 Dry Lining Flush Mount MK backbox

K2214 ALM



K2214 ALM Metal surface mount MK backbox for use with 800 Series addressable ancillaries using 517.035.007 cover.

Product Code

517.035.011
K2214 ALM Metal Surface Mount MK backbox

K2142



K2142 White plastic surface mount MK backbox for use with 800 Series addressable ancillaries using 517.035.007 cover.

Product Code

517.035.010
K2142 White Plastic Surface Mount MK backbox

8621C



8621C Steel flush mount MK backbox for use with 800 Series addressable ancillaries using 517.035.007 cover.

Product Code

517.035.014
8621C Steel Flush Mount MK backbox

Technical Specification

Product Code	MK Ref	Mounting	Dimensions	Knockouts	Earth Screw	Material
517.035.011	K2214	Surface	146x86x40mm	1x20mm rear/7x20mm sides	Yes	Steel
517.035.010	K2142	Surface	146x86x34mm	One rear (25x35mm)	N/A	Plastic
517.035.014	8621C	Flush	132x72x26mm	4x20mm rear/12x20mm sides	Yes	Steel
517.035.015	QFB/2	Flush/ Dry Lining	146x85x38mm	2 top & bottom	N/A	Plastic

Callpoints



Features

- Integral LED indicator for easy identification of operation
- Surface or flush mounting
- Extensive range of digital addressable callpoints
- Test key facility, speeds maintenance visits
- Hazardous areas models available (See Special Hazards Section)
- IP67 Waterproof models for external applications

CP Series Callpoints

A comprehensive range of callpoints for use with addressable systems. All the callpoints are designed to enable an alarm signal to be given by breaking a glass element.

This operates a switch and is indicated by an LED indicator. If required, an optional transparent hinged cover may be installed to guard against accidental operation.

Technical Specification

(Indoor & Outdoor)

Housing:	PC/ABS
Operating Temp.:	
Outdoor	-25°C TO +70°C
Indoor	-10°C TO +55°C
Relative Humidity:	up to 95% RH (non-condensing)

Chapter 2 - MZX Technology

Callpoints CP820/MCP820M/CP830/MCP830M

Indoor Callpoint

Weight: 110g

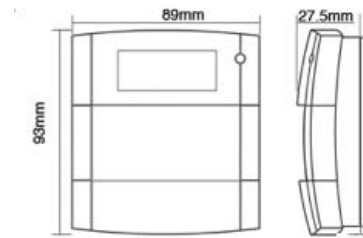

Outdoor Callpoint

Weight: 240g

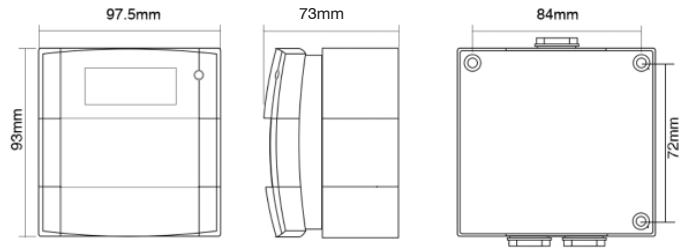

CP820/MCP820M Indoor Callpoint



The CP820 is an indoor MX addressable manual callpoint with programmable status LED. The CP820 is designed for LPCB approvals and the MCP820M for Marine approvals. The CP820 provides high speed communication to the MX panel of a manual fire alarm.

Technical Specification

Meets BS5839 Pt.2 and pr EN54

Pt:11

EMC/RFI: EN50130-4/
EN61000-6-3

Operating Temp.:
-10° to +55°C

Relative Humidity:
up to 95% RH
non-condensing

Dimensions:
93H x 89W x 59.5D
(27.5 mm flush mount)

Weight: 110g

IP Rating: 24D

Product Codes

[514.800.603.T](#)

CP820 Indoor Callpoint
(Thorn Branded)

[514.800.603.A](#)

CP820 Indoor Callpoint
(ADT Branded)

[514.800.603.Y](#)

CP820 Indoor Callpoint
(TYCO Branded)

[514.800.609](#)

MCP820M Indoor Callpoint c/w
Isolator

CP830/MCP830M Outdoor Callpoint



The CP830 is an outdoor MX addressable manual callpoint with programmable status LED. The CP830 is designed for LPCB approvals and the MCP830M for Marine approvals. The CP830 provides high speed communication to the MX panel of a manual fire alarm.

Technical Specification

Meets BS5839 Pt.2 and pr EN54

Pt:11

EMC/RFI: EN50130-4/
ENG61000-6-3

Operating Temp.:
-25° to +70°C

Relative Humidity:
up to 95% RH
non-condensing

Dimensions:
93H x 97.5W x 73Dmm

Weight: 240g

IP Rating: 67

Product Codes

[514.800.604.T](#)

CP830 Outdoor Callpoint
(Thorn Branded)

[514.800.604.A](#)

CP830 Outdoor Callpoint
(ADT Branded)

[514.800.604.Y](#)

CP830 Outdoor Callpoint
(TYCO Branded)

[514.800.610](#)

MCP830M Outdoor Callpoint c/w
Isolator

Chapter 2 - MZX Technology

Callpoint Ancillaries

**Product Codes**

90-107

Red M141 spacer for red CP200/800 KAC callpoints



515.001.045

Test key for all MCP and CP style callpoints



515.001.128

Callpoint hinged cover for use with MCP callpoints models (Colour -Clear)



515.001.026

Black callpoint bezel for CP200/800 models.

Ancillaries - Back Boxes

**Product Codes**

515.001.021

Standard Red surface mounting back box for MCP & CP indoor callpoints

Unless stated the indoor callpoints are supplied as flush mount units. The range is approved for use with the standard backbox. However, SR2-T backboxes are also available.



10-115

SR2-T Optional Back Box (2 terminals)

Callpoint Spare Glasses - Current

**Product Codes**

515.001.119

EN54 Part 11 Spare Glass for MCP and CP series Callpoints (Pack of 5)

515.001.127

Deformable operating unit "glass" for use in place of glasses, for kitchens or other areas where glass is not acceptable. For MCP callpoints only.

515.001.025

CP200/500/900 Glasses, clear English text on white background. No logo (Pack of 5).

Features

- Prevents accidental operation of callpoints
- Strong polycarbonate construction
- Optional break seal kit



STOPPER

The callpoint STOPPER provides protection from malicious or accidental activation of manual callpoints. Available for flush or surface mounted callpoints the 'STOPPER' is also available with optional high pitch sounder which is activated when the lid is lifted.

An optional 'Break-Seal' fitting kit allows 'Break-Seals' to be used to provide extra protection.

WARNING:- Break seals should only to be fitted by agreement with relevant fire authorities.

The STOPPER is suitable for all callpoints up to 100mm square.

Product Code	Ref	STOPPER		STOPPER II	With Sounder	Weatherproof
		Flush	Surface			
515.001.029	STI6530	✓				
515.001.030	STI6531		✓			
515.001.036	STI6535		✓			✓
515.001.034	STI1230			✓		
515.001.035	STI3150			✓		✓
515.001.031	STI6532	✓			✓	
515.001.032	STI6533		✓		✓	

STOPPER Dimensions

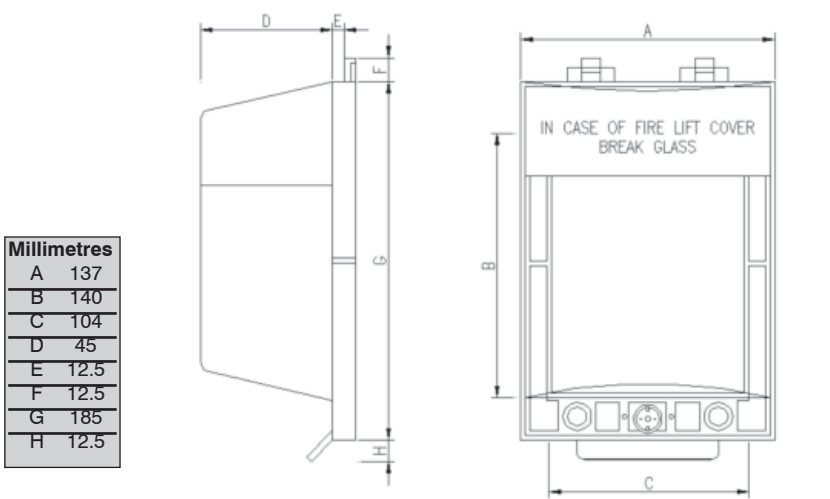

Product Code

515.001.033 IPO36 Break Seal Kit (pack of 1)

	Flush Fit	Surface Fit (+30mm)
Stopper	STI6530	STI6531
Stopper with Sounder	STI6532	STI6533

	STOPPER	STOPPER II
Max. Callpoint Size	100 x 100mm	160 x 160 mm
Max. Callpoint Depth	57.5	120 (+30mm Surface)

STOPPER II Dimensions

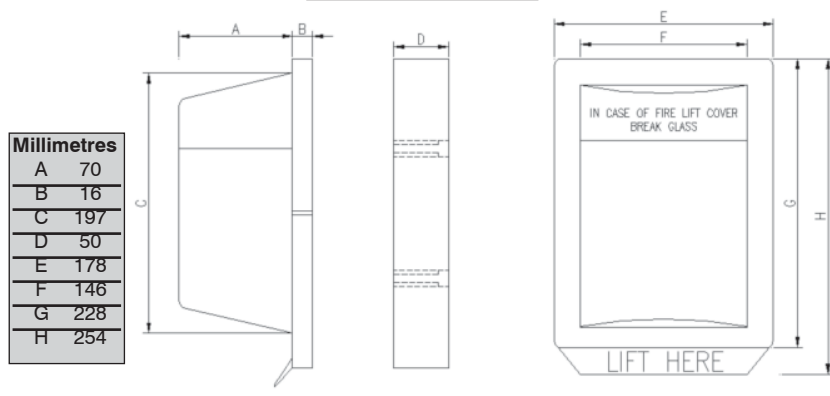

Stopper II Surface Fit - STI1230



Features

- Strong polycarbonate construction
- Tamper resistant

STOPPER II

The STOPPER II is constructed as the STOPPER from tough injection moulded polycarbonate. Physically larger than the STOPPER the STOPPER II extends the number of products to which these tough multi-purpose covers can protect.

It consists of a strong tamper-proof clear polycarbonate cover and frame that fits easily over such products as break glass callpoints.

STOPPER II can also be fitted with an integral battery powered sounder which activates if the cover is lifted.

The STOPPER II is suitable for callpoints up to 160mm square.

Product Code

515.001.034 STI1230 Surface fit STOPPER II



Features

- Strong polycarbonate construction
- Provides environmental protection
- Ideal for offshore environments

Weather STOPPER & Weather STOPPER II

The Weather STOPPER and Weather STOPPER II extends the life of weather exposed devices, such as break glass callpoints, by offering protection against harsh conditions and environments. Experience has shown that this protective cover can extend the life of products installed in saline atmospheres, such as oil rigs and ship decks.

While offering environmental protection the Weather STOPPER and Weather STOPPER II are constructed from tough durable polycarbonate which will also guard against tampering, vandalism or accidental operation of devices such as emergency switches.

Product Codes

515.001.036 STI6535 Surface fit Weather STOPPER
515.001.035 STI3150 Surface fit Weather STOPPER II

Smoke Beam/CCTV Guard



The Smoke Beam/CCTV Guard is manufactured from tough coated steel rod and is designed to protect projected beam detectors or CCTV cameras from vandalism or accidental damage.

Suitable for use with System Sensor, Hochiki and Fireray 2000 detectors.

Technical Specification

Dimensions: 260H x 200W x 321D mm

Product Code

516.015.009
STI9625 Smoke beam/CCTV guard

Keybox



This tough polycarbonate breakglass keybox is available to protect emergency keys.

Product Code

515.001.043
STI6720 Keybox with printed glass

Sounders & Beacons



Features

- Wide range of both bells and electronic sounders
- High sound output characteristics
- Low current consumption
- Clean lines, modern styling
- Easy to install, low installation costs
- Weatherproof units for outdoor use
- Distinct sounds are available
- Motorised and Solenoid bells available
- Wide range of voltages available

Sounders

A range of sounders to meet a wide variety of alarm applications where loud, penetrating and distinctive warnings must be given to alert people of fire situations.

In addition, multi-tone electronic sounders can give a variety of sounds to signal other conditions e.g. "extinguishing gas release imminent," etc.

Note: For I.S. & Flameproof sounders, please see the special hazards section in Chapter 10.

Loop Powered Sounders & Beacons



Sounder/Beacon and Sounder Bases

One Point of Installation – Unique Solution with Huge Savings

Combining a detector base, sounder, beacon and line isolator in one low cost unit will result in a dramatic reduction in the final installation cost. Typically 40% to 55% of the installation costs per point can be saved. This presents an exciting opportunity for sellers in the DDA compliant market. This is achieved without the need for specialist high cost detector heads as standard 800 series Minerva® MX detectors are used.

Unique

When used with the 801PC 3oTec detector ADT can provide a completely unique solution combining fire detector, toxic gas detector, isolator, sounder and beacon into a single very cost effective point of installation.

Reflective Sound Monitoring (RSM) – Patented* Solution significantly reduces Risk

Reflective Sound Monitoring is employed to monitor the audio output of the LPSB3000 and LPAV3000 by listening to the output and reporting any sounders that are not working. RSM is a Tyco patented* technology and was successfully introduced with the Minerva® MX Loop powered Symphoni sounders. It is particularly beneficial during regular weekly sounder tests where users can be satisfied that all their sounders are working, even if the building is not fully occupied at the time of the test. Failure of the beacon would also generate a fault at the Minerva® MX control panel.

Technical Specification

System	For use with MX/ZX fire alarm controllers
Environment	Up to 95% RH (non condensing) IP Rating 21 C EN60529
Temp- Operating	-20°C to +70°C
Temp - Storage	-25°C to +70°C
Dimensions	102 mm dia x 42 mm high
Weight:	LPSB3000 0.160 kg LPAV3000 0.170 Kg
Materials	Housing ABS FR & Polycarbonate
EMC	The range complies with the following: Product family standard EN50130-4 in respect of conducted disturbances, radiated immunity, electrostatic discharge, fast transients and slow high energy EN61000-6-3 for emissions

Features

- High output programmable sounder base and sounder beacon base
- One point of installation for detector, isolator, sounder & beacon
- Loop powered from the MX Technology® Digital Loop
- High brightness Multi-LED Beacon
- Software programmable
- 15 Tones and 2 Flash Rates
- Integral line isolator
- RSM (Reflective Sound Monitoring)
- Can be used as a standalone device using the sounder blanking cap
- Optional surface mount plastic conduit adaptor

Loop Power Capacity

The advanced 3000 series sounders and beacons are independently addressed and are therefore separately controllable from the Minerva® MX Digital loop. The maximum number that can be driven from a single loop is dependant on the number of addresses available, the volume selected and the flash rate of the beacon. MXDesigner version 5.0 should be used to accurately determine loop loading and battery size. Typically, at full volume of 90dBA, 50 x LPSB3000 sounders or 35 x LPAV3000 sounder beacons at 0.5Hz flash rate can be driven by a single 1Km loop. That gives a typical maximum of 280 sounder beacons at full volume from a single 8 loop Minerva® MX panel.

Built-in Isolation

As the line Isolator is now integral to the device the need for separate line isolation devices is reduced.

Tones

15 Tones are available from the sounder, which include tones compatible with the LP Symphoni range, 802SB sounder base and the LPBB520 (loop powered Besson Banshee). 4 sound levels 60dB to 90dB (±3dB) and 2 flash rates 1/2Hz & 1Hz are available.

MXConsys

The AV base range of devices are fully supported by Consys Version 14 and later, the point input dialog box provides an easy method for setting the Tones, Volume and Flash rate of the device. The only operation required at the device is to set the address using the 850EMT device programmer.

Product Codes

516.800.957	LPSB3000 Sounder only L/P addressable base
516.800.958	LPAV3000 Sounder beacon L/P addressable base
516.800.959	DAB3-4 Mounting flange – type B for conduit (supplied in packs of 10)
557.001.040.A	Mark 2 Sounder Cap (ADT Branded)
557.001.040.Y	Mark 2 Sounder Cap (Tyco Branded)

Note: Detectors supplied separately



Features

- Loop Powered – Reduced installation costs
- High Output/Low consumption – Lower lifetime costs
- Indoor and Outdoor models – Same sounder tones in all areas
- Sounder/LED Beacon Version – DDA Compliant
- 16 Tones and 2 Flash rates – Suits individual requirements
- Reflective Sound Monitoring RSM - Reassurance that ALL sounders are working
- Integral Line Isolator – Saves cost and installation time

Loop Powered Symphoni Sounders and Sounder Beacons

Models Available

The Sounder only models are available with a red or white housing suitable for indoor use and an IP65 rated red housing for outdoor applications.

The Audio / Visual models, which incorporate a highly efficient LED beacon, are also available with a red or white housing for indoor use and an IP65 rated red housing for outdoor applications.

Reflective Sound Monitoring

Up to now sounder circuits have been monitored up to the EOL but not the individual sounders, fault detection has relied on human feedback from the weekly tests that should be carried out to meet the requirements of BS5839.

The LP Symphoni utilising Reflective Sound Monitoring (RSM) employs a transducer to actively monitor the units sound output during the weekly sounder test and will report back to the MX controller if it fails to detect the sounder operating when it has been commanded to, this ensures that the LP Symphoni range of sounders will in the unlikely event of a fault, display it immediately on the fire controller and is therefore not dependant upon the staff within a building reporting a sounder failure.

Technical Specification

Operating temp:

Indoor devices -10°C to +55°C

Outdoor devices -20°C to +70°C

IP rating:

Indoor devices IP21C

Outdoor devices IP65

EMC:

Product family standard EN50130-4 in respect of Conducted Disturbances, Radiated Immunity, Electrostatic Discharge, Fast Transients and Slow High Energy

EN61000-6-3 for Emissions

Built-in Isolation

As the line Isolator is now integral to the device the need for separate line isolation devices is reduced.

Tones

16 Tones are available from the sounder, which include tones compatible with the 802SB sounder base and the LPBB520 (loop powered Besson Banshee). Dutch slow whoop and the DIN 1Hz sweep are included. Two sound levels 103dB & 90dB (± 3 dB).

MXConsys

The LP Symphoni range of devices will be fully supported by Consys Version 10 and later, the point input dialog box provides an easy method for setting the Tones, Volume and Flash rate of the device. The only operation required at the device is to set the address using the 850EMT device programmer.

Product Codes

516.800.960	LPSY800-R L/P Symphoni (indoor use) red
516.800.961	LPSY800-W LP Symphoni (indoor use) white
516.800.962	LPSY865 L/P Symphoni IP65 (outdoor use)
516.800.963	LPAV800-R L/P Symphoni Sounder/Beacon (indoor use) red
516.800.964	LPAV800-W L/P Symphoni Sounder/Beacon (indoor use) white
516.800.965	LPAV865 L/P Symphoni Sounder/Beacon IP65 (outdoor use)

Bells



Features

- CE marked
- Low current 6" bell (ONLY 11mA)
- Low cost
- Extra high 95dBA/m
- Slim profile (53mm)
- Fully suppressed and polarised
- Quick and easy to install
- LPCB approved to EN54 Pt 3

6" & 8" Motorised Bells

Model	MBF-6EV	MBF-8EV	MBA 8EV
Rated Voltage	24V d.c.	24V d.c.	24V d.c.
Rated Current	11mA	17mA	18mA
Sound output	90-95dBA	90-97dBA	91-97dBA
Operating Temp	-12 to +50°C		-10 to +50°C
Colour	Red		
Weight	410g	640g	1100g with back box

Product Codes

576.501.039.A	MBF-6EV ADT Branded
576.501.039.T	MBF-6EV Thorn Branded
576.501.040.A	MBF-8EV ADT Branded
576.501.044.A	MBA-8EV ADT Branded
576.501.044.T	MBA-8EV Thorn Branded
576.501.045	BBX4 (2) W/P Backbox for MBA-8 Bell



Features

- Weatherproof Option
- Flexible Mounting Option
- Attractive Design

Electronic Solenoid Bell

Unique patented alarm bell with miniature solenoid and integrated electronic control. No backbox required for surface wiring.

Technical Specification

Dimensions:	6" diameter
Voltage:	18-30Vdc
Typical Current:	30mA @ 24Vdc
Typ. Sound Output:	94dB (A) @ 1m

Product Codes

20-100	6" 24Vdc Electronic bell, weatherproof IP33C - Wormald Branded
20-101	6" 24Vdc Electronic bell - red IP21C - Wormald Branded
20-111	6" 24Vdc Electronic bell - white IP21C

Marine Approved Products

576.501.407	MED 6" 24Vdc Electronic bell, weatherproof - red IP33C
576.501.408	MED 6" 24Vdc Electronic bell - red IP21C



Features

- Low Current Consumption
- Suppressed and Polarised
- Sturdy Construction

CF Motorised Bell

The CF Motorised Bell is low current, fully suppressed and polarised.

Technical Specification

Dimensions:	6" Diameter
Colour:	Red
Output Voltage:	20-28Vdc
Typical Current:	25mA @ 24Vdc
Typical Sound Output:	95dB (A) @ 1m

Product Code

Marine Approved Product

576.501.405	MED 6" Red 24Vdc Motorised bell, "Fire" text with Thorn Branding
-------------	--

Electronic Sounders



Features

- Modern aesthetic design
- 32 Selectable tones
- 3 Volume settings
- Push and twist mount
- Shallow and deep bases
- Available in red or white
- Low current consumption
- 2 Stage alarm available
- Independently switched sounder or beacon
- Xenon beacon with the Excel Lite

Banshee Excel Sounders

The Banshee Excel sounder replaces the Banshee Multi Tone range of Sounders. It uses the same technically superior rocking arm transducer to reproduce the familiar 32 tones of the previous Banshee and Bedlam ranges.

Banshee Excel Lite Sounder Beacon

The new Banshee Excel adds the Banshee Excel Lite Sounder Beacon to its range using a high output xenon with the familiar sounder. The Banshee Excel Lite can be used as a multi stage device by switching the beacon and the sounder independently using a third wire.

Technical Specification

Approvals:	VdS approved to EN54-3
Tones available:	32
Operating voltage:	9-30Vdc
Tone current consumption:	See Tone Table in Chapter 11
Flash current consumption:	40mA
Operating temperature range (Deg C):	-40 to +70
Volume control via DIL switch:	Maximum, Medium (-10dBA), Low (-20dBA)
Flash rate per second:	1
Ingress Protection:	IP45 or IP66
Termination:	Screw terminals for 028mm ² to 2.5mm ² wire conductor

Product Codes

576.501.060	Banshee Excel sounder, red, IP45 (replaces 576.501.005.A & 576.501.005.T)
576.501.061	Banshee Excel sounder, white, IP45 (replaces 576.501.009 & 576.501.025.A)
576.501.062	Banshee Excel sounder, red, IP66 (replaces 576.501.016.A & 576.501.016.T)
576.501.063	Banshee Excel Lite, red sounder, red xenon beacon, IP45

Accessories



The combined mounting bracket for the Besson Multi-tone Banshee and Xenon Beacon allows quick and neat installation of combined sounders and beacons. The bracket allows the following electronic sounders to be mounted with the range of 1W Xenon Beacons:

- Besson Banshee
- MINERVA FIRECRYER voice enhanced sounder

The bracket can be used with any of the 24Vd.c 1W Xenon beacons in red, clear, amber or blue (Part no.'s 540.001.030/031/032 & 033)

Product Code

576.501.047
Banshee/Xenon bracket

Besson Wafer Sounder



The standard Besson Wafer sounder is supplied in white with a blank cover included. The specification is as follows:

Input voltage: 24V d.c. (+/-25%)
Sound Output: 60dBA/90dBA at 1m typical (pot. Adjustable) offering the same sound formats as the Banshee sounder range. It can therefore be used in conjunction with the Banshee sounders on the same site.

Technical Specification

Current: 4mA to 15mA

Temperature Range:
-40°C to + 70°C

Dimensions:
Dia 103mm, Height 22mm (excluding coverplate)

Product Code

576.501.038
Besson wafer sounder and blank cover in white

Flush Mount Bedroom Sounder



Meeting the requirements for BS5839 part 1, the Bedroom Sounder range is well suited to hotels and residential environments where aesthetics is a prime concern. Matching the sound output of the Banshee range of sounders so therefore they can be mixed on the same site.

Features

- Low current consumption 7mA
- Dual sound options selected via a jumper switch: 'Continuous' and 'Fast Sweep' 90dB
- Can be both Flush and Surface mounted
- Robust terminal connectors to accommodate up to 2.5mm² conductors

Product Codes

576.501.032.A
Flush Mount Sounder ADT Branded
576.501.032.T
Flush Mount Sounder Thorn Branded

Yodalarms



This versatile range of sounders are ideally suited for fire, safety and security hazard warning.

Technical Specification

Dimensions:
YO3: 89H x 89W x 85D mm
YO5: 134H x 134W x 128D mm
YO8: 216H x 216W x 153D mm

Product Codes

576.501.001
YO3 Yodalarm 3" 24Vdc 100dB @ 1Mtr
576.501.002
YO5 Yodalarm 5" 24Vdc 106dB @ 1Mtr
576.501.003
YO8 Yodalarm 8" 24Vdc 112dB @ 1Mtr

24Vdc Symphoni Sounder



The 24Vdc Symphoni Sounder is a general purpose internal sounder, available either as a very high output sounder for noisy areas, or a high output low current sounder for applications where power is limited. Both versions share the same horn and backbox which has double cable entries for ease of installation.

The low power version has 3 selectable tones which may be employed for one, two or three stage alarm applications. The high output version has 32 selectable tones and retains full tone compatibility with the Roshni, Squashni and Askari product ranges.

Product Codes

- 576.501.200
SY/R Low Power Red Symphoni Sounder (3 tone)
- 576.501.201
SY/W Low Power White Symphoni Sounder (3 tone)
- 576.501.202
SYHO/R High Output Red Symphoni Sounder (32 tone)
- 576.501.203
SYHO/W High Output White Symphoni Sounder (32 tone)

Technical Specification

Model	Symphoni High Output	Symphoni (Low Power)
Operation	2 Hours Continuous	Continuous
Operating Voltage Range	9-28Vdc	12-30Vdc
Sound Output @ 1m	Up to 120dB(A)	100dB(A) +/- 2dB(A) @24Vd. c.
Volume Control		Down to 80dB approx.
Current Consumption	240mA +/- 20mA on Tone 3	5mA +/- 1mA at all volumes
Tones	1 to 32	Alternating 990Hz/650Hz@2Hz Continuous 990Hz Intermittent 990Hz, On/Off@1Hz
Synchronisation	Synchronised Start	Synchronised Start
Frequency Stability	+/- 0.15%	+/- 0.5%
Operating Temperature	-25 °C to +55°C	-25°C to +70°C
Line Monitoring Method	Polarised Input	Polarised Input
Construction	ABS Plastic Case	ABS Plastic Case
Ingress Protection	IP21C	IP21C
Weight	0.58Kg	0.212Kg

Roshni



A flexible alarm sounder for Fire and Security applications complete with volume control and dil switch to provide 32 tones.

Low profile Roshni with Deep base offers IP65 protection. All Roshni sounders have synchronised start for self synchronisation without third wire.

Technical Specification

Dimensions: 93 Dia x 105D mm (Deep base)
Colour: Red or white
Output Voltage: 9-28 Vdc
Typical Current: 16mA @ 24Vdc
Typ. Sound Output: 102dB @ 1m

Product Codes

- ROSHRDSR
ROSHNI Sounder c/w deep base - red
- 576.501.220
ROSHNI Sounder c/w shallow base - red
- 576.501.221
ROSHNI Sounder c/w shallow base - white
- 576.501.222
ROSHNI/Flashni Deep Base - Red
- 576.501.223
ROSHNI/Flashni Deep Base - White

Marine Approved Products

- 576.501.401
MED W/P ROSHNI Sounder c/w deep base-red
- 576.501.402
MED ROSHNI Sounder c/w shallow base-red



Features

- Single Message or Multiple Message using the same sounder
- Multi Message facilitates multi evacuation strategies
- Clear and unambiguous alarm messages
- Voice Alarm Messages provoke an immediate response
- Sound Output – Up to 100db(A) (Fire-Cryer® Plus), 90db(A) (Mini Fire-Cryer® Plus), 110db(A) (Midi Fire-Cryer® Plus)
- Optional integral Red Strobe
- Low current consumption – average 20mA
- No special wiring easily retro fitted
- Fully synchronised over multi zones
- Deep base version available to IP66
- Ultra slim base sounder to fit industry standard detectors
- Suitable for ceiling or wall mounting (Mini Fire-Cryer® Plus)
- Optional front plate for stand alone use (Mini Fire-Cryer® Plus)
- Voice Message Controller makes manual message switching easy

Fire-Cryer Plus® - Voice Enhanced Sounders

The Fire-Cryer® Plus range of voice sounders are electronic sounders which are pre-programmed with 9 messages. Each of the Fire-Cryer® voice sounders can be used as a single message voice sounder by simply installing them on to a conventional 24Vdc sounder circuit or by using a sounder controller on a loop. The choice of message(s) broadcast can be selected using a DIL switch on the rear of the sounder. **See Table A**

The Fire-Cryer® Plus offers an excellent service upgrade opportunity for systems as well as a highly flexible and cost effective solution to providing a voice evacuation system to many buildings. The choice of Fire-Cryer® voice sounders can be selected using **Table B**

Messages 1 to 7 in **Table A** can be used in a multi message installation with the addition of a Multi Message Switching PCB (576.501.171) or a Voice Message Controller (576.501.181 or 576.501.182) interfaced between the fire alarm control panel and the sounder circuits. The Voice Message Controllers can be supplied with a 2.5A or 5.25A power supply built in. A Zone Extension PCB (576.501.172) is available to extend the system to 4 zones or 8 sounder circuits. **See Table C**

A special Extinguishing PCB (576.501.173) used with the 576.501.135 will enable 1st, 2nd Stage, 'Hold' and 'Gas Released' messages to be automatically broadcast dependent on the state of the alarm. **See Table A1**

Chapter 2 - MZX Technology

Fire-Cryer® Plus Multi Message PCB



Product Code
576.501.171 Fire-Cryer® Plus Multi Message PCB

Fire-Cryer® Plus Zone Extension PCB



Product Code
576.501.172 Fire-Cryer® Plus Zone Extension PCB

Fire-Cryer® Plus Extinguishing PCB



Product Code
576.501.173 Fire-Cryer® Plus Extinguishing PCB

Din Rail Mounting Kit for Fire-Cryer® Plus Extinguishing PCB



Product Code
557.201.303 Din Rail Mounting Kit

IP66 Housing for Fire-Cryer® Plus Extinguishing PCB



Product Code
557.201.410 IP66 Housing

VMC / Multi Message PCB and 2.5A PSU



Product Code
576.501.181 VMC / Multi Message PCB and 2.5A PSU

VMC / Multi Message / Zone Extension PCB and 5.25A PSU



Product Code
576.501.182 VMC / Multi Message / Zone Extension PCB and 5.25A PSU

Technical Specification

Fire-Cryer® Plus Model	Fire-Cryer® Plus	Mini	Midi
VDC Operating Voltage	20-28	20-28	20-28
Current mA @ 24VDC Peak/Avg - Sounder only	27/20	27/20	180/100
Current mA @ 24VDC Typical: Sounder with low current strobe	33/26	n/a	n/a
Current mA @ 24VDC Typical: Sounder with high current strobe	52/60	n/a	n/a
Current mA @ 24VDC Low current strobe only	13	n/a	n/a
Current mA @ 24VDC High current strobe only	32	n/a	n/a
Strobe Output Cd (LOW)	2	n/a	n/a
Strobe Output Cd (HIGH)	6	n/a	n/a
Volume Adjustment from Max. dBA Output to max output -18dBA	82 to 100	72 to 90	101 to 110
Weatherproofing (IP66 requires Deep Base)	IP45 or IP66	n/a	IP44
Housing Material	ABS	ABS	Aluminium/ Plastic Base
Temperature Range °C	-25 to +70	-10 to +55	-25 to +70
Colour	Red or White	White	Red
Connections	Screw TB 1.5mm ²	Screw TB 1.5mm ²	Clamp 2.5mm ²

Figure 1 - Direct Connection to FACP

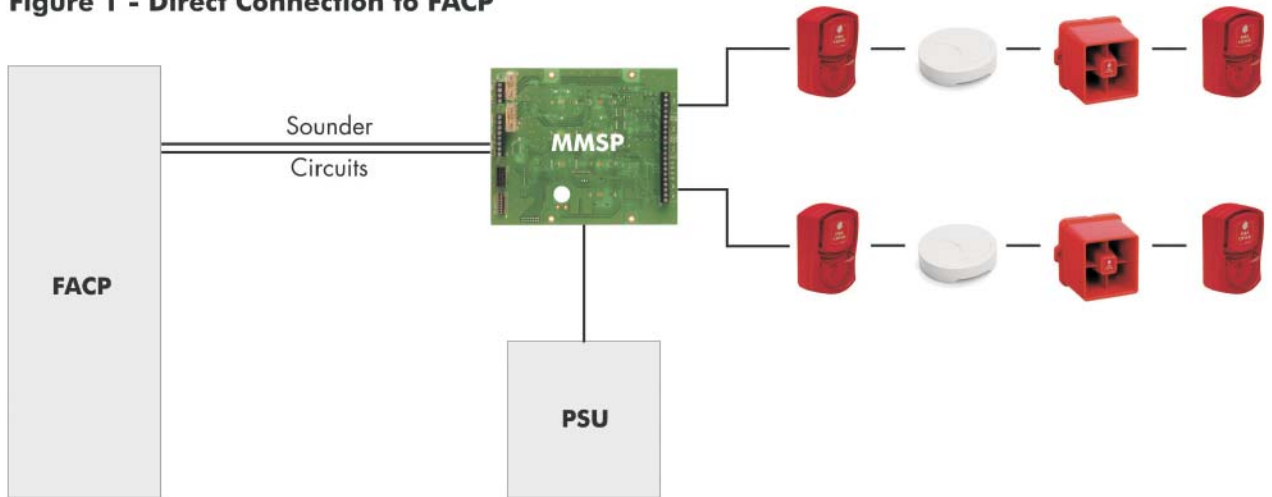
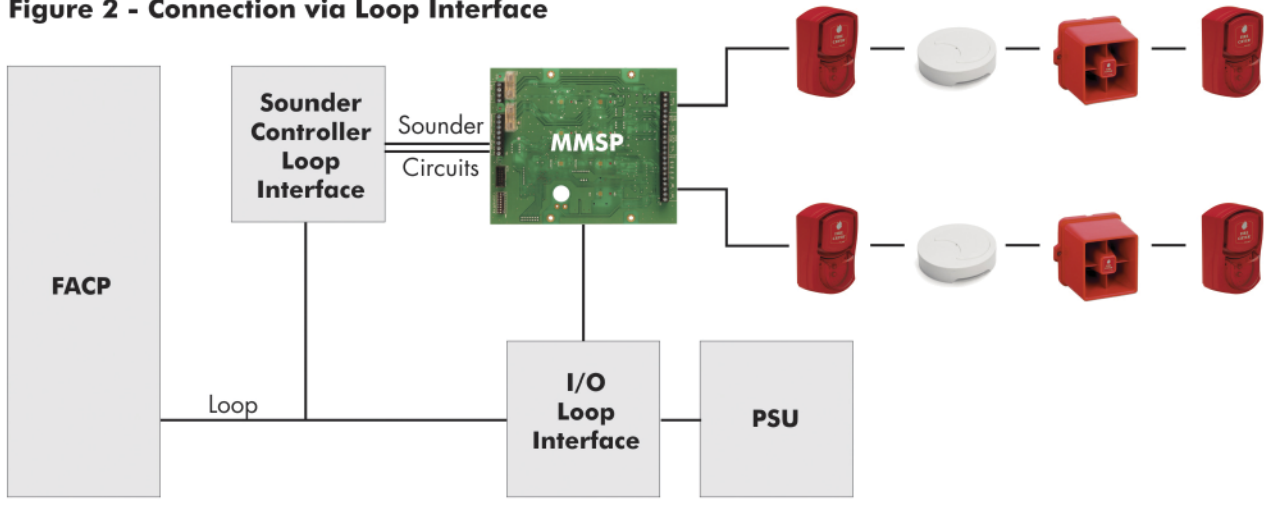

Figure 2 - Connection via Loop Interface



Chapter 2 - MZX Technology

Standard Message Set which consists of 9 pre-programmed messages with tones (See Table A)

When used as a Multi Message sounder DIL Switches 4, 5, 6, 7 and 8 are OFF. When used as a single message sounder use the DIL Switch settings in the table below 1 = ON, 0 = OFF

When used as a Multi Message Sounder the Multi Message Switching PCB (576.501.171) will assign the messages to the following triggers:

Message	Starting Tone (See Table (A2) below)	Two Letter Message Code	Beacon Flashes Y/N	Speech Message		SW4	SW5	SW6	SW7	SW8
Message 1	1	AK	Y	Fire emergency. Please remain calm and evacuate the building immediately	S1A/S1B	1	0	0	0	0
Message 2	2	AB	Y	This is a fire alert. This is a fire alert. Await further instructions. Await further instructions.	MA	0	1	0	0	
Message 3	2	MA	Y	Standby alert. Close all blinds and move to the middle of the room.	MB	1	1	0	0	0
Message 4	0	AD	N	All clear. All clear. No further action required.	MC	0	0	1	0	0
Message 5	0	SP	N	This is an ADT fire test. No action required.	MD	1	0	1	0	0
Message 6	3	CC	N	This is a class change announcement.	ME	0	1	1	0	0
Message 7	1	AF	Y	Fire detected. Keep calm. Leave the building by the nearest exit.	MF	1	1	1	0	0
Message 8	2	AZ	Y	Ladies and gentlemen – due to unforeseen circumstances we must ask you to leave the building immediately by the nearest exit or as directed by members of staff.		0	0	0	1	0
Message 9	2	AX	Y	We have an emergency situation. Please leave the building by the nearest exit. Members of staff will assist you.		1	0	0	1	0

Table A1 GAS EXTINGUISHANT MESSAGES (Used with 576.501.135)

Message	Starting Tone (See Table (A2) below)	Two Letter Message Code	Beacon Flashes Y/N	Speech Message
1st Stage	2	CG	Y	First stage extinguishant release warning.
2nd Stage	2	CH	Y	Second stage extinguishant release warning.
Hold	0	LU	N	Extinguishant gas release on hold.
Gas Released	1	CJ	Y	Extinguishant released.

Table A2

Tone	Description
0	No tone
1	Banshee LF Fast Sweep. 800Hz to 950Hz swept @ 9hz
2	Banshee LF Fast Sweep. 800Hz to 950Hz swept @ 9hz Pulsed at 1 second ON, 1 second OFF
3	Bell tone, pulsed

Chapter 2 - MZX Technology

Ordering Fire-Cryer Plus® Voice Sounders

Step 1 - Choose your Fire-Cryer® Sounder



Table B				
Type	Body Colour	Beacon	Base	Part Ref.
Wall Mount	Red	Red	Shallow	576.501.131
			Deep	576.501.132
		None	Shallow	576.501.133
			Deep	576.501.134
Wall Mount	White	Red	Shallow	576.501.141
		None	Shallow	576.501.142
Wall Mount	Red	Red	Shallow	576.501.135
Wall Mount	Red	None	Deep	576.501.151
Base Mount	White	None	N/A	576.501.161

Step 2 - Choose your Interfaces for Multi Message Systems

Table C				
Standard Multi Message Switching PCB				576.501.171
Zone Extension PCB (adds 3 Zones of 2 Sounder Circuits i.e. 6 sounder circuits. Must be used with 576.501.171)				576.501.172
Extinguishant Interface PCB				576.501.173
Voice Message Controllers & PSUs (All VMC enclosures include a 576.501.171)				
576.501.171	576.501.172	PSU	Box Size	Part Ref
Yes	No	2.5A	M2	576.501.181
Yes	Yes	5.25A	M3	576.501.182
Box Sizes	M2 Enclosure 385W x 310H x 90D mm			
	M3 Enclosure 385W x 520H x 90D mm			

Product Codes

576.501.131	Standard Fire-Cryer® Plus, red wall mounted, shallow base, red beacon
576.501.132	Standard Fire-Cryer® Plus, red wall mounted, deep base, red beacon
576.501.133	Standard Fire-Cryer® Plus, red, wall mounted, shallow base
576.501.134	Standard Fire-Cryer® Plus, red, wall mounted, deep base
576.501.135	Standard Fire-Cryer® Plus (for use with 576.501.173 in Gas Extinguishant systems)
576.501.141	Standard Fire-Cryer® Plus, white wall mounted, shallow base, red beacon
576.501.142	Standard Fire-Cryer® Plus, white, wall mounted, shallow base
576.501.151	Midi Fire-Cryer® Plus, c/w back box, red
576.501.161	Mini Fire-Cryer® Plus, base mounted, white, c/w cover
576.501.052	Mini Fire-Cryer® Plus, voice enhanced base sounder cable spacing ring
576.501.171	Fire-Cryer® Plus Multi Message PCB
576.501.172	Fire-Cryer® Plus Zone Extension PCB
576.501.173	Fire-Cryer® Plus Extinguishing PCB
557.201.303	Din Rail Mounting Kit for Fire-Cryer® Plus Extinguishing PCB
557.201.410	IP66 Housing for Fire-Cryer® Plus Extinguishing PCB
576.501.181	Voice Message Controller c/w Multi Message PCB and 2.5A PSU
576.501.182	Voice Message Controller c/w Multi Message PCB, Zone Extension PCB and 5.25A PSU
576.501.191	Fire-Cryer® Plus Demo Unit

Beacons

Single Gang Lamp/Buzzer Units



Lamp Buzzer units may be used for local alarms when high level audible warnings may not be appropriate. Available in flush and surface mount versions to fit standard single gang backboxes.

Features

- Low Current
- Flush or Surface Mount
- Hi-Brightness LED

Technical Specification

Dimensions: 90H x 90W
x 40D mm
Current Rating: 15mA at 24Vdc
nominally

Product Codes

[540.011.012](#)
Single gang flush mount LED (red)/Buzzer Unit labelled 'Fire Alarm'
[540.011.013](#)
Single gang surface mount LED (red)/Buzzer Unit labelled 'Fire Alarm' c/w surface backbox.

Solista LED Beacon



Ultra low power requirement 3mA or 6mA at 24Vdc. Long life low profile design. Protected to IP54, supplied complete with base.

Product Code

[576.501.230](#)
Solista LED Beacon (Red)

Easy AV™ Retrofit LED Beacon



This low power LED beacon is designed to be retrofitted to existing Banshee electronic sounders. Easy and fast installation typically 3 min. Low power 6mA max at 24Vdc. High Output LEDs.

Product Code

[576.501.012](#)
Easy AV strobe for Banshee Sounders



Features

- Available in 1, 2, 3 and 5 watts
- Protected to IP65
- Attractive low profile design
- Optional bracket for mounting both Beacon and Banshee Sounder

Xenon Beacons - 24V Including Surface Mount Adaptor

This high quality range of Xenon beacons are tested to IP 65 making them ideal for the most stringent applications.

Each beacon incorporates a low profile Fresnel lens designed to give maximum light output.

Technical Specification

Voltage Vdc	Power Output Watt(s)	Alarm Current mA	Flash Rate	Rating	Temp. Range	Dimensions (mm)	
						Height	Diameter
24	1	42	60/min	IP65	-30 to +70°C	51	75
24	2	84	60/min	IP65	-30 to +70°C	51	75
24	3	126	60/min	IP65	-30 to +70°C	51	75
24	5	210	60/min	IP65	-30 to +70°C	75	90

Product Codes

540.001.030	Low profile clear 24Vdc 1 watt
540.001.031	Low profile blue 24Vdc 1 watt
540.001.032	Low profile amber 24Vdc 1 watt
540.001.033	Low profile red 24Vdc 1 watt
20-112	Low profile red 24Vdc 2 watt
20-113	Low profile red 24Vdc 5 watt
20-120	Low profile red 24Vdc 3 watt



Flashni

A combined sounder and beacon which combines the features of the Roshni electronic sounder with a fully integrated Xenon beacon.

Technical Specification

Dimensions:	93 Dia x 92D mm (Shallow base)
	93 Dia x 121D mm (Deep base)
Input Voltage:	18-30Vdc
Typical Current:	68mA@24Vdc
Typ. Sound Output:	101dB (A)@1m

Features

- Combined strobe & sounder
- Matches Roshni sounders
- Weather Resistant to IP65

These sounders are fully compatible with all Roshni tones.

Product Codes

20-118	Combined Roshni sounder/strobe complete with deep base (IP65).
576.501.224	Combined Roshni Sounder/Strobe, Red Body/Red Lens complete with shallow base & tone switch.
576.501.227	Combined Roshni Sounder/Strobe, Red Body/Red Lens, deep base, tone switch & separate sounder/strobe operation.

Marine Approved Product

576.501.403	MED Combined Roshni Sounder/Strobe, Red Body/Red Lens complete with shallow base
-------------	--



Squashni G3/AV Sounder Beacon

This low current combined sounder/beacon is ideal for standalone usage utilising the optional blanking cap or can be used in conjunction with a 4" base and detector. When used with a detector it will provide a single point of installation for the detector, sounder and beacon.

Features

- Combined Sounder and LED Beacon
- Low Current -10mA @ 24VDC
- 6 selectable tones
- Volume control (2 levels)
- White housing, clear lens with red LED's
- DDA compliant audio visual solution for UK
- Neat unobtrusive design
- Ideal for hotels, care homes, schools & offices
- Independent power cables allow a large number of AV platform sounders to be driven from a single 24V circuit
- 90dB sound output
- > 1Cd light output at 1 Hz
- Approved to EN54-3

This is a conventional sounder / beacon and needs to be powered from the panel sounder outputs or a sounder module.

Product Codes

576.501.250	Squashni G3/AV Sounder Beacon
576.501.255	Squashni G3/AV Blanking Cap – Pack of 5
517.050.041	4B 4" Detector Base

Software Tools & Accessories

MX Technology Fire controllers are supported by a comprehensive suite of software programmes which provide key features to enable fast and accurate configuration and commissioning of the MX systems.

MXConsys

MXConsys, the highly flexible and extremely powerful programming tool that has been used successfully with MX systems since day one. Specially designed for MX it is constantly being extended and refined to meet ever changing demands. Available for free download from the Tyco Fire and Security Website but requires a dongle and license to operate.

Incorporated into MXConsys is MXConsys-Express – An alternative approach to system configuration that simplifies the programming effort by automating many of the processes. Its heart lies in a number of pre-defined templates that have been expertly designed to match a selection of building types. The demands on users in terms of experience and training are considerably reduced.

MXDesigner

MXDesigner is a sophisticated engineering design tool that not only ensures system parameters and design rules are obeyed but are key to the ordering and documentation processes. Battery calculations, loop loading calculations, remote bus parameters, system schematics and parts lists are all included. The extensive use of graphics and 'drag and drop' techniques makes the system easy and quick to use. In addition, a design module for the intrinsically safe MXDigital detectors and associated system 800 components is included. Available for free download from the Tyco Fire and Security Website.

MXFlow

MXFlow - If you have ever been involved in the configuration process for a complex 'cause and effect' programme, you will appreciate the benefits of an automated method of documenting your work. MXFlow does just that; it takes your MXConsys 'event action' and transcribes it into a graphical format that is comprehensive and easy to follow. It can be a valuable commissioning tool that saves time and effort as well as an easily understood form of documentation for future service use.

Available for free download from the Tyco Fire and Security Website to authorised personnel.

MXChecker

MXChecker - MXChecker replaces, in software, all configured MX loop devices on a single panel. It offers a user the following major functionality:

Connection to a panel directly, or indirectly via the MXNetwork (in the same way Consys does to perform a download/upload).

Provides the input status of each and every device configured on the Loops, e.g. make a Sounder go 'No Response', a detector appear active, etc. The ability to display the General Status of each and every Point configured on the Loops, e.g. indicate a Sounder is Isolated, a Callpoint is Disarmed, a Detector is Resetting, etc. The ability to display the Output Status of each and every Point configured on the Loops, e.g. indicate a Sounder is being driven to P1, a Relay Module is not being driven, etc.

MXLogger

MXLogger – MXLogger enables the engineer to selectively monitor any device or devices on the addressable loops. The returned values are displayed on a PC screen and can be saved to a file for later analysis. Available for free download from the Tyco Fire and Security Website.

MXRemote

MXRemote - Remote communications software provides a fast and efficient means of diagnosis without anyone having to leave the office. In situations where access to a site may be difficult or where an attending technician requires high level assistance then MXRemote is the tool for the job. Using modems, MXRemote can link to the MXDigital fire system via PSTN or IP and once connected, becomes an integral part of the fire system, acting as a fully functional repeater. All system functions are then available to the MXRemote operator. Available for free download from the Tyco Fire and Security Website but requires a dongle and license to operate.

MXService Tool

The TYCO MXService tool is a powerful and flexible tool for assistance in the installation, commissioning, diagnostics and service of Tyco MX detection systems. The MXService tool allows all MX addressable devices to be interrogated, tested and programmed. Suitable for desktop or single handed operation the MXService tool is battery operated using standard rechargeable batteries.

MXLoop Tester

The MXLoop Tester can test, commission and fault-find a loop of up to 250 MX analogue addressable detectors/devices, without a fire panel. A laptop is generally used for operation & display, but a "One Person Installation Mode" is automatically enabled on power up.

Identifies all devices on the loop, determining addresses and types. Over-addressed (>250), unknown device types, and, generally, duplicate addressed devices are recognised. Monitors analogue values of all detectors/modules on the loop to determine device status: normal/alarm/fault/dirty etc.

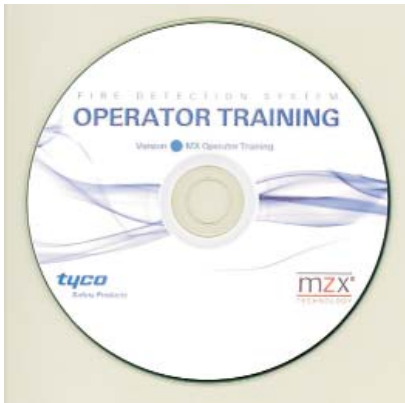

Features

- MZX Product Line Overview.
- Key Terms & Conditions.
- Key Functions & Features.
- System Display and Controls.
- Set Time and Date.
- Enter Pass Codes.
- Customer Operator Access Levels.
- Accept Fire Alarm Events.
- Accept Incoming Events.
- Walk Test.
- Isolate Detectors.
- Isolate Field Devices.
- View Status of a Loop Device.
- View Event Log.
- Interpret System Faults.
- Carry out Routine Testing.

MZX Interactive Training CD

An Operator Training CD which contains an interactive training programme that provides information on the MZX Fire Detection System.

Product Code

TCD-1 MZX Interactive Training CD

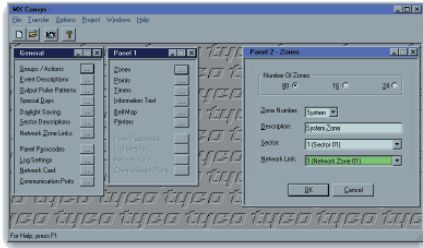

MXConsys

MXConsys is a powerful Windows programming tool which provides full system programming functions and project configuration and issue control. MXConsys is used on MINERVA MX, MX2,T2000 & MZX panels.

Features

- Programs the system across multiple sub-panels
- Downloads to the system from one point
- Provides Firmware download as well as configuration download
- Dongle protected
- Provides full project configuration printouts. Includes MX consys express

It also supports automatic data transfer to MXGraph & TXG graphical mimic and alarm management systems. MXConsys is available under document control from authorised personnel in the Tyco businesses.

Product Codes

557.203.001	MXConsys Dongle and license (parallel)
557.203.003	MXConsys Dongle and license (USB)
557.202.118	MXConsys Download lead



MXRemote

MXRemote is a Windows based software tool for remote service and support of MX detection panels. MXRemote provides a full function fire panel repeater running on a PC either locally or over dial up telephone lines or via the internet. Providing the operator has the correct passwords MXRemote allows all operator, manager, service and engineer functions available at the panel to be provided at the PC.

Features

- Facilitates remote diagnostics
- Display identical to panel view
- Remote Assistance

This allows the customer or the Tyco service organisation to provide remote assistance, service and limited configuration assistance to the installation.

MXRemote is available as a stand-alone software application for Tyco service operations. Alternatively Tyco Fire Protection Products are able to provide consultancy and assistance in implementing MXRemote as an integrated part of a central station and service centre system.

Product Codes

557.203.002	MXRemote Dongle and license (parallel)
557.203.004	MXRemote Dongle and license (USB)
557.202.116	MX-FIM Modem Lead
UDS1100	Lantronics Device Server LAN

Programming and Service Tools

Features

- Simplifies installation and commissioning
- Reduces the possibility of engineer error
- Improves health and safety by removing the need to work at height
- Provides peace of mind through evidence based digital reporting



850EMT Engineering Management Tool

The engineering management tool communicates with the 850 series and 830 series devices using a 2 way infrared wireless link. Commissioning data is held within the 850 EMT and the technician will be prompted to select and confirm configuration details resulting in an evidence based commissioning document that can be downloaded from the programmer.

Technical Specification

- 2 way wireless infrared communication with detectors
- TFT colour touch screen display
- Save time with One Visit Commissioning (OVC)
- Facilitates evidence based commissioning
- Read/write the detector/ancillary address
- Display and confirm zone and point strings
- Display temperature/ CO levels / smoke obscuration
- Programme the device LED
- Initiate detector self verification test
- Display detector dirtiness level
- Control ancillary outputs
- Read ancillary statuses
- Compatible with all 800 series devices

Product Codes

- 516.850.900 850EMT engineering management tool
- 516.800.922 Spare ancillary programming lead
- 516.800.924 Pack of 10 spare pins for ancillary lead
- 516.800.923 Accessory kit (Carry case, shoulder strap & car 12v adaptor)





MXService Accessory Kit

A carry case which contains the following items:-
Car Lighter Adapter
Shoulder Strap

This provides space for the following:-
850EMT Engineer Management Tool
Ancillary Programming Lead
Mains Charger

Features

- Compact
- Organises Tools
- Sturdy Construction Protects Tools

Product Code

516.800.923 850EMT Engineer Management Tool
accessory kit



MZX AVR Programmer

This unit will allow the MZX Technology® Fire Controller Loop Drivers to be updated to the latest software version. When required upgrades can be performed easily and quickly in the field with minimal system downtime. The MZX AVR Programmer is designed for use with MX, MZX, ZX and T2000 addressable fire controllers, please check document 17-05-AVR for compatibility details.

Features

- Pre-Programmed with latest AVR firmware
- Powered from XLM Loop card or FIM, No external power required
- Simple to operate
- Compact handheld device
- Complete with ribbon cable and connector

Technical Specification

2 Button Keypad
3 Status LEDs
Operating Temperature 0°C to 50°C
Size 189 x 80 x 31

Product Code

516.800.941 Tyco MZX AVR Programmer



MXLoop Tester

The MX Loop Tester can test, commission and fault-find a loop of up to 250 MX digital addressable detectors/ devices, without a fire panel. A laptop is generally used for operation & display, but a "One Person Installation Mode" is automatically enabled on power up.

Identifies all devices on the loop, determining addresses and types. Over-addressed (>250), unknown device types, and, generally, duplicate addressed devices are recognised. Monitors analogue values of all detectors/modules on the loop to determine device status: normal/alarm/fault/dirty etc. Provides alarm test for detectors that support it.

Allows Walk Test. Any device going into alarm is shown on the laptop with address and time. Walk Test Status (devices not tested yet) can be requested. Walk test mode overrides detection algorithm delays for fast testing.

Technical Specification

Powered from 110V/230V mains supply via 24V, 3A plug pack, or from 24V batteries (batteries not included).

Dimensions

Unit: 200mm x 122mm x 46mm

Carry Bag: 250mm x 250mm x 70mm

Weight: 2 kg (without battery)

Features

- Ability to commission loops without a panel
- Verify installed loops before connection to panel
- Fault find loops whilst disconnected from panel

Monitors loop current and status, identifying open / short and over-current conditions. Details devices present on each side of break (so that position of break or tripped isolator can be determined).

Includes commands to operate device LED and control output modules (relays and sounders).

Turns on LED of faulty detectors (when there is no alarm) to aid visual identification.

Automatic addressing mode allows un-programmed devices to be added in sequence and be automatically addressed. Detailed diagnostics and commissioning modes via laptop.

Product Codes

557.203.021	MXLoop tester with EUROPEAN/UK MAINS to IEC CABLE
557.203.022	SPARE ECM prog DB6 (FEM) - DB9 (FEM) null modem
557.203.023	Spare carry bag with 2 pockets and strap
557.203.024	Spare PSU 90-264VAC IN/24VDC 3A out
557.203.026	Spare MX loop tester battery lead set



MX Service Case

There are 11 main circuit boards shared between the Minerva® MX4000 and MX2 Control Panels, Repeater Panels and Black Box Panels. The MX Service Case is designed to hold one of each board in a convenient lightweight and portable case that will protect the boards whilst taking the minimum amount of space in a service engineer's vehicle. The case also contains a fault finding manual.

Features

- Lightweight
- Convenient
- Compact

The MX Service Case allows a service engineer to carry onto site, sufficient spares to effect a panel repair efficiently and in a professional manner. It will avoid unnecessary return trips to the service vehicle or branch to collect spares and negates the need to carry cumbersome panels & enclosures in service vehicles.

Product Code

557.202.298	MX Service Case
-------------	-----------------

Service & Spares

Keys & Keyswitches

557.203.005	Set of spare keys for MX Panel (AL102)
557.180.209	Keyswitch assembly for use with MX2 controllers (spare)
557.180.208	MX2 Spare Keys
557.201.508	MZX Spare Key Set

Housings & Metalwork

557.201.300	BFP801 Blank Half Module - Grey Overlay
557.201.306	Standard MX Expansion backbox and chassis plate
557.201.310	Deep MX Expansion backbox and chassis plate
557.202.206	MX2 expansion aperture installation kit

CPU FIMs & Loop Cards

557.202.000	FIM801 1-Loop Field I/F Module
557.202.001	FIM802 2-Loop Field I/F Module
557.202.008	FIM801CV – T2000CV only
557.202.007	XLM800 2-Loop Expansion Card
557.202.002	CPU800 Central Processor Unit

Power Supplies

557.202.003	PSM800 Power Supply Unit
557.202.004	LBM800 Loop Booster Module PCB
557.202.210	PSU830 Power Supply with Loop Booster
557.202.208	MX2 8 Loop Expansion kit
557.201.210	Dual power supply mounting kit
557.202.050	PSM800 Temp Sensor Accessory Kit
557.202.113	PSB to FIM Cable
557.202.608	PMM800 Power monitor module
557.202.609	BAQ60T24 2.5A MZX PSU
557.202.610	BAQ140T24 5A MZX PSU
557.202.611	PMM805 Power Monitor Module - 5V Repeater
557.202.612	PMM840 Power Monitor Module - 40V Loop Power

Indication & Expansion

557.202.013	OCM800 Operator Control Module
557.202.019	ODM800 Operator Display Module
557.202.021	ANN840 40-Way Alarm/Fault LED Module
557.202.022	ANN880 80-Way Alarm LED Module
557.202.020	COM820 20-Way Status/Command Module
557.202.200	DCM800 MX2 Display Control Module (without LCD assy)
557.202.601	DCM816 16 zone display PCB for MZX125/MZX16R
557.202.602	DCM832 32 zone display PCB for MZX250/251/252
557.202.209	MX2 LCD assembly
557.202.028	RSM800 Power Supply
557.180.053	Isolated RS485 IC (for U16)
557.180.052	Serial Printer Driver Kit
557.202.613	DCM864R Spare Display / Control PCB for MZX 253 (64 red zonal LEDs)
557.202.614	DCM8240 240 zone display PCB for MZX254 and MZXDR

Callpoint Key & Glasses

515.001.045	MCP test key
515.001.119	MCP EN54 Spare Glasses pk of 5

MX Service Tool

516.800.922	MX Service tool, Spare programming lead
516.800.924	MX Service tool, Spare pins for programming lead pk of 10

MX Loop Tester

557.203.022	MX Loop Tester ECM Prog Null Modem
557.203.023	MX Loop Tester Carry Bag
557.203.024	MX Loop tester PSU
557.203.026	MX Loop Tester Battery lead set

Flammable Gas Detector

516.100.051	Spare Flammable Gas Detector Sensor
516.100.052	Spare Flammable Gas Detector PCB

This page is left intentionally blank.

Control Panels and Repeater Panels



Features

- 2, 4 and 8 zone versions available.
- Supports the complete range of EN54 approved series 600 detectors including photo multi-sensor and CO multi-sensor.
- Supports Tyco twin wire sounders on all eight detection zones.
- Drives up to 3 repeater panels (4 and 8 zone panels).
- Access to controls via key switch.
- Space for 2 x 3.4 A/H batteries providing up to 72 hour standby.
- Remote control inputs for class change, alert, evacuate, silence alarms and reset.
- Zone 1 configurable for latching or non latching.
- Selectable zonal or general alarm sounder operation.
- Alert sounder option.
- Configurable zone co-incidence for automatic detectors.
- Fully monitored fire signalling output.
- Single pole volt free change over fire relay output.
- Single pole volt free change over fail safe fault relay output.
- Short circuit fire option.
- Auxiliary 24VDC 250mA power supply output.
- Open collector output for buzzer active, disablement active and evacuate active.
- Earth fault monitoring.
- Zone/Output disablement for each zone, fire signal output and all sounders.
- Buzzer disable feature.
- One man zone test.
- One man sounder test.
- Automatic fire detector and manual alarm call point fire event discrimination.
- Alarm counter.
- Compatible with diode bases for detector removal.

Minerva® MZX-c

The Minerva MZX-c range of conventional twin wire firealarm control panels will satisfy a wide range of applications from 2 to 8 zones and have many features that are normally associated with more expensive addressable systems.

The Minerva MZX-c range of conventional fire detection control panels are designed to be both installer and user friendly. A high degree of flexibility and programmability allows the systems to be customised without the need for any configuration software.

The range consists of 2, 4 and 8 zone panels together with an 8 zone repeater which is compatible with the 4 and 8 zone variants. The matching repeater panel has an inbuilt 240Vac power supply.

Chapter 3 - Conventional Systems

Technical Specifications

	Panels			Repeater
	2 Zone	4 Zone	8 Zone	8 Zone
Electrical				
Mains Supply	230VAC +10% - 15%			
Power Consumption (max)	138W			
PSU/Charger Output	1.5A			
Sounder Circuits 24VDC Nominal	2 x 0.5A	4 x 0.5A	4 x 0.5A	N/A
Aux DC Output 24VDC Nominal	0.25A			N/A
Maximum Battery Space	2 x 3.4 A/H (PS-1230)			
Environmental				
Operating Temperature	-5°C to +40°C			
Operating Humidity	95% Non Condensing			
Mechanical				
Dimensions (W x H x D mm)	365 x 273 x 110			
Weight Excl Batteries Kg	2.2			
Enclosure Colour	Light Grey RAL7035			

Product Codes

- 508.031.004.EG MZX-c 2 ZONE PANEL TYCO 2 WIRE
- 508.031.005.EG MZX-c 4 ZONE PANEL TYCO 2 WIRE
- 508.031.006.EG MZX-c 8 ZONE PANEL TYCO 2 WIRE
- 508.031.016.EG MZX-c 8 ZONE REPEATER PANEL



Features

- 4, 8, 16 and 32 zone versions available
- Semi-Flush mounting using optional bezel
- Supports the complete range of EN54 Approved Series 600 Detectors including photo multi-sensor and CO multi-sensor
- Compatible with System 620 ATEX and IECEx approved intrinsically safe system
- Extensive custom options programmable via switches and front panel controls
- Two stage alarms and investigate delay options
- Day/Night modes and alarm counter (with optional timer module)
- Full EN54 zone operation with options for non-latching, short circuit alarm or indication only circuits

Minerva® MZX-c+ (Does not support Tyco twin wire sounders)

The MZX-c+ range of Conventional Control Panels are designed to be both installer and user friendly.

They are designed and manufactured to a high standard and are approved by LPCB to EN54 parts 2 & 4.

These Panels are available in 4,8,16 & 32 zone versions along with suitable Repeaters for all models.

The 8 to 32 Zone Panels are capable of driving any combination of 8 channel output expansion boards (relays, alarm circuits & open collector 0v outputs) up to a maximum of 12 boards which can be set to zonal activated or common output modes.

Each Panel has extensive configuration options but remains easy to install, program and operate and are supported by detailed documentation on commissioning, operation and maintenance.

The Panels are designed to work with a wide range of manufacturers detectors (in addition to Tyco detectors) and are suitable for use in many types of installation including upgrades and new installations

Ancillaries and Expansion

- C1631 Repeater Interface Board provides a port for driving up to 5 repeater panels. One C1631 Repeater interface board is required for the panel and one for each repeater. Repeaters are supplied with a C1631 fitted.
- C1630 Output Expansion Interface Board provides a port for driving up to 12 output expansion boards.
- EXP 4 and EXP 4 PSU Expansion Housings are designed to house any combination of up to four output expansion boards. The PSU version is equipped with a 5A 24Vdc power supply with space for 2 x 12V 12Ah batteries. Housing dimensions 325W x 370H x 126D mm
- EXP 5 and EXP 5 PSU Expansion Housings are similar to the EXP 4 and EXP 4 PSU but accommodate five output expansion boards. Housing dimensions 400W x 441H x 131D mm

- C1633 LED Driver Board provides eight open collector outputs rated @ 60mA. Outputs can be zonal alarm or common alarm.
- C1634 Relay Output Module provides eight volt free changeover contacts rated at 1A 30Vdc. Outputs can be zonal alarm or common alarm.
- C1635 Monitored Output Board provides eight fault monitored 24Vdc outputs. Power can be derived from the control panel or an external source. Outputs can be zonal alarm or common alarm..
- C1651 MZX-c+ Timer Module is an optional plug-in board with an alphanumeric LCD to provides a real-time clock display. The clock can be programmed to provide investigate delays, sequential alarms and day night settings. The unit is also used to store and display a total count of the number of times the panel enters the alarm condition. Can be fitted to 8, 16 and 32 zone panels.

Additional Benefits

- Inputs for remote Silence, Evacuate, Reset and Class change
- Configurable monitored or volt free outputs for Fire, Fault and Protection
- Outputs for zones 1 to 4 (open collector) with 8, 16 or 32 zonal outputs provided by optional expansion boards
- Outputs for Disablement active, Evacuate active and buzzer active (open collector)
- Volt free reset relay. Active for 10 seconds following a panel reset
- 8 to 32 zone systems can drive up to 12 expansion input / output modules per panel
- Drive up to 5 repeater panels

Chapter 3 - Conventional Systems

Technical Specifications

	Panels				Repeaters		
Electrical							
	4 Zone	8 Zone	16 Zone	32 Zone	8 Zone	16 Zone	32 Zone
Mains Supply	230Vac +10% - 15%						
Power Consumption	85W	165W	165W	240W	85W	85W	85W
PSU / Charger Output	1.5A	3.0A	3.0A	5.0A	1.5A	1.5A	1.5A
Sounder Circuits 24Vdc nominal	4 @ 500mA	4 @ 1A	4 @ 1A	4 @ 1A	N/A	N/A	N/A
Aux. DC Output 24Vdc nominal	500mA	1A	1A	1A	N/A	N/A	N/A
Maximum Battery Space	2 x 3Ah	2 x 7Ah	2 x 12Ah	2 x 17Ah	2 x 3Ah	2 x 3Ah	2 x 3Ah
Environmental							
Operating Temperature	-5 to +40 °C						
Operating Humidity	5% to 95% non-condensing						
Mechanical							
Dimensions (W x H x D mm)	325x370x126			400x441x131	325x370x126		400x441x131
Space for 8 way expansion	N/A	2 Boards	2 Boards	Use Exp Hsg	N/A		
Weight Excl. Batteries Kg	6.2	7.1	7.1	10.25	6.2	6.2	7.6
Enclosure Colour	RAL7035 Light Grey						

Product Codes

508.032.002.EA	MZXC+ 4 Zone Panel English/Arabic
508.032.003.EA	MZXC+ 8 Zone Panel English/Arabic
508.032.004.EA	MZXC+ 16 Zone Panel English/Arabic
508.032.005.EA	MZXC+ 32 Zone Panel English/Arabic
508.032.006.EA	MZXC+ 8 Zone Repeater 240Vac English/Arabic
508.032.007.EA	MZXC+ 16 Zone Repeater 240Vac English/Arabic
508.032.008.EA	MZXC+ 32 Zone Repeater 240Vac English/Arabic
508.032.012	MZXC+ 4 Way Expansion Housing
508.032.013	MZXC+ 4 Way Expansion Housing with PSU
508.032.014	MZXC+ 5 Way Expansion Housing
508.032.015	MZXC+ 5 Way Expansion Housing with PSU
557.201.502	Flush Mount Bezel for MZXC+ 4/8/16 Zone Panel and Repeater
2605060	C1630 O/P Expansion Interface Board
2605061	C1631 Repeater Interface Board
2605062	C1632 16 Zone Interface Board
2605063	C1633 LED Driver Board
2605064	C1634 Relay Output Board
2605065	C1635 Monitored Output Board
2605070	C1651 MZX-c+ Timer Board



T1200 Conventional Marine Controller

Developed and Manufactured in the United Kingdom the T1200 range of Conventional Panels are a powerful yet user friendly series of Control Panels. The range is fully approved by all major Marine Authorities and takes advantage of the very latest technological advancements both in terms of design and manufacturing to the latest European, Marine and Asian standards.

Benefits

Allows very early detection of accommodation fires with significantly reduced false alarms when used with Tyco's unique heat enhanced Compensated Carbon Monoxide (CCO) Detector.

Configurable Detection Zones allowing zones to be configured for any or all of the following :- Latching or Non Latching Fire Indication Normal or Intrinsically Safe Zone Monitoring of Machinery space zones.

Crew Alert Mode :- Manages Alarm Annunciation.

Pre-configured for Immediate use.

Detection Options

Optical Detector - An excellent all round detector suited to all applications.

High Performance Optical (HPO) Detector - A direct replacement for the Ion Chamber Smoke Detector.

Flame Detector- Used where there is a risk of large flaming fires e.g. Machinery Spaces.

Enhanced Compensated Carbon Monoxide (CCO) Detector – The best detector for early warning without false alarms, used in life threatening applications e.g. Cabins, Public Spaces etc.

Heat Detector - Used where smoke detectors cannot be used e.g. Galleys, Laundries, Drying Rooms etc.

Extensive configuration options using simple on board DIL switches and links.

Features

- Developed for use in vessels which require between 4 and 32 zones of fire detection.
- Compact 4 zone option for Console Mounting.
- Range includes a separate Water Mist Panel.
- Integrated Voyage Data Recorder output on 16 and 32 Zone Panel.
- No external secondary power source required.
- Discrimination between Automatic Fire Detectors and Manual Alarm Call points to provide the appropriate response.
- Optional Marine Approved Muster Alarm.
- Text label Inserts for Controls and Indicators in customer supplied language.

Fault Finding Features

- The following fault finding indications are available :-
- General Fault - Any Fault Condition.
- Power Supply Fault - Mains or standby power supply/ charger fault.
- System Fault - Micro Controller or memory fault.
- Earth Fault - Positive or Negative Power Supply Earth Fault.
- Fuse Fault - Auxiliary Supply Fuse Failure.
- Repeater Fault - Repeater Fault or Repeater communications failure.
- Sounder Fault - Any Sounder Fault.
- Fire Protection Fault - Fault on the Fire Protection Output.
- Fire Output Fault - Fault on the Fire Output.
- Fault Output Fault - Fault on the Fault Output.

Technical Specification

Dimensions:

T1204 & T1216RDC	– 335w x 270h x 148d mm
T1216 & T1216R	– 420w x 445h x 148d mm
T1232/T1216W/T1232RAC/T1232RDC/T1200EA/T1200EDC	– 500w x 535h x 174d mm
T1200B	– 335w x 170h x 102d mm

Environmental

IP Rating:	Designed to IP56
Operating Temp:	-10°C to +55°C
Humidity:	95% RH (non condensing)

Chapter 3 - Conventional Systems

Product Codes

508.023.001	T1204DC 4 ZONE PANEL C/W 1.5A 24VDC PSU (requires T1200B battery box)	Spares	
508.023.002	T1204A1 4 ZONE PANEL C/W 1.5A 110VAC PSU (requires T1200B battery box)	509.023.001	C1626 4 ZONE PANEL MOTHERBOARD C/W AC PSU
508.023.003	T1204A2 4 ZONE PANEL C/W 1.5A 230VAC PSU (requires T1200B battery box)	509.023.002	C1626 4 ZONE PANEL MOTHERBOARD WITHOUT AC PSU
508.023.004	T1216 16 ZONE PANEL C/W VOYAGE DATA O/P MODULE & 5.0A 110/230VAC PSU	509.023.003	C1627 16 ZONE PANEL MOTHERBOARD WITHOUT AC PSU
508.023.005	T1216W 16 ZONE WATER MIST FIRE DETECTION PANEL C/W 2 X 8 WAY ZONAL RELAY OUTPUT MODULES (C1634) AND 5.0AMP 110/230VAC PSU	509.023.004	C1627 16 ZONE PANEL MOTHERBOARD WITHOUT AC PSU FOR T1232
508.023.006	T1232 32 ZONE PANEL C/W VOYAGE DATA O/P MODULE & 5.0A 110/230VAC PSU	509.023.011	C1626 REPEATER MOTHERBOARD C/W AC PSU
508.023.011	T1216RDC 16 ZONE REPEATER WITHOUT PSU	509.023.012	C1626 REPEATER MOTHERBOARD WITHOUT AC PSU
508.023.013	T1216RA2 16 ZONE REPEATER C/W 1.5A 230VAC PSU	509.023.021	C1628 4 ZONE PANEL DISPLAY
508.023.014	T1232RDC 32 ZONE REPEATER WITHOUT PSU	509.023.022	C1628 16 ZONE PANEL DISPLAY
508.023.016	T1232RA2 32 ZONE REPEATER C/W 1.5A 230VAC PSU	509.023.023	C1629 32 ZONE PANEL DISPLAY
508.023.021	T1200EA EXPANSION BOX C/W 5.0A 110/230VAC PSU	509.023.031	C1628 16 ZONE REPEATER DISPLAY
508.023.022	T1200EDC EXPANSION BOX (NO PSU)	509.023.032	C1629 32 ZONE REPEATER DISPLAY
508.023.023	T1200B BATTERY BOX FOR T1204 4 ZONE PANEL	2605060	C1630 OUTPUT EXPANSION INTERFACE BOARD
508.023.025	T1200 RMRS DOOR STAY KIT	509.023.042	C1632 16 ZONE PANEL EXPANSION BOARD
2605061	C1631 REPEATER INTERFACE BOARD	509.023.051	PS136 5.0A 110/230VAC PSU
2605063	C1633 LED DRIVER BOARD	509.023.052	PS40 1.5A 24VDC PSU
2605064	C1634 RELAY OUTPUT BOARD	509.023.061	T1200 & T1200-C SPARE KEY SET
2605065	C1635 MONITORED OUTPUT BOARD		
508.023.035	C1665 MUSTER INTERFACE BOARD		
508.023.036	A1466 RELAY OUTPUT BOARD		
508.023.051	T1216 ENGLISH/CHINESE/JAPANESE INSERT SET		
508.023.052	T1232 ENGLISH/CHINESE/JAPANESE INSERT SET		
508.023.053	T1216R ENGLISH/CHINESE/JAPANESE INSERT SET		
508.023.054	T1232R ENGLISH/CHINESE/JAPANESE INSERT SET		

Extinguishing Panels, Repeaters & Accessories



MZX-e Extinguishing Control Panel

The MZX-e gaseous extinguishant control panel is powerful yet user-friendly and is designed and manufactured to a high standard. The panel features approval to BS EN 12094- 1:2003, BS EN 54-2 and 4 and is designed to BS 7273 part 1. The panel has extensive configuration options but is easy to install, programme and operate. The removable chassis enables the engineer to “first fix” an empty cabinet and then fit the chassis at the commissioning stage.

This is supported by comprehensive documentation on commissioning, operating, maintenance and fault finding. In addition there is a comprehensive range of compatible accessories available to meet most customer requirements.

Operation

Three fully-monitored detection zones are provided. Zones 1 and 2 normally provide first stage and second stage fire conditions to allow extinguishant discharge (coincidence detection zones). Zone 3 is an auxiliary zone for detection only purposes. Zone 4 is used as a manual release zone.

Facilities

Three fully-monitored alarm circuits are provided, each rated at 0.5A with various configuration options via the engineers DIL switch settings. Two circuits are designed to provide audible warning of any fire condition and one circuit to provide an individually distinct audible warning of the pre-discharge, discharged and emergency hold condition.

Two fully-monitored actuator/solenoid circuits, each rated at 1A, operate simultaneously upon “extinguishant release”.

An RS485 multi-drop circuit link supports up to 7 Status Controller/Indicators of any type mixed on the communication path. Additional terminals and configuration options allows the engineer to configure the manual release, abort and hold switches to either data comms or hard wired inputs as required.

Features

- Approval to BS EN 12094-1:2003 additional options
- Approval to BS EN 54-2 and 4
- Designed to BS7273-1:2000
- Comprehensive facilities for gaseous extinguishing systems
- Monitored inputs for gas discharged, gas low, isolation valve closed/abnormal, gas trapped in manifold
- Control inputs for auto/manual, gas hold, gas abort
- 1 minute actuator cut off option
- Monitored actuator/solenoid release
- Extensive disablement options
- Common fire, fault, relay / monitored output facilities
- 1st, 2nd, 3rd stage and gas discharged relay / monitored output facilities
- Reset relay facilities

Normally-open inputs provide for remote evacuate, silence alarms, system reset, lock-off input, low pressure and gas discharged pressure switch input.

Outputs are provided for first stage signalling, second stage signalling, system discharged, common fire and common fault . These outputs may be configured as either Volt-Free C/O contacts or monitored 24V (50mA) outputs. A system reset Volt-Free relay is also provided.

Configuration

The use of DIL switches on the internal motherboard enables the engineer to easily configure the extensive options available and view the panel’s configuration upon any return visit.

Additional Benefits

- Intrinsically safe barrier settings
- Metron or solenoid compatible
- Single or double knock operation
- Pre-discharge delay adjustable from 0 to 60 seconds
- Discharged indication with or without pressure switch
- Inhibit silence alarms until gas discharged
- Latching or non latching fault indication option
- Option for rapid buzzer pulse when gas discharge is imminent
- One man zone and sounder test
- Easily removable chassis

Product Codes

- 508.033.050.EA MZX-e Extinguishing Control Panel English / Arabic
- 508.033.002.EA MZX-e SLU1 Status Lamp Unit, Indication only English / Arabic
- 508.033.003.EA MZX-e SLU2 Status Lamp Unit, Indication, Auto/Manual Select and Manual Release English / Arabic
- 508.033.004.EA MZX-e SLU3 Full Function Status Lamp Unit, Indication, Auto/Manual Select, Manual Release, Hold, Abort & Time Counter English / Arabic
- 508.033.005.EA MZX-e SLU4 Weatherproof Status Lamp Unit, Indication and Auto/Manual Select English / Arabic

Chapter 3 - Conventional Systems

Extinguishing Door Interlock Ancillaries & T500 Series Spares

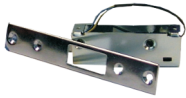

A microswitch lock keep can be used with a deadlock to provide a signal to the panel to ensure that the extinguishing system is only put into Automatic mode when the door is locked shut.

Product Codes

527.001.028
 Micro-switch Lock Keep & Back-plate For Deadlock
 599.001.012
 Lamp 28V 60mA Used On T525

T561 Electrical Manual Release Unit



A stand alone manual extinguishant release unit with selectable activation and end of line resistors making the T561 compatible with MZXE, Prescient 3, System 1700 and NTR Extinguishing Panels.

Product Code

509.030.117
 T561 Extinguishing Release Manual Callpoint.

Weatherproof Extinguishing Indicator Units



E1 Single Red lamp unit
 Single 24V d.c. red lamp labelled 'Extinguishing System Operated'

Product Codes

540.007.001
 E1 Single Red lamp unit
 Heavy Duty IP67 Cast Aluminium Surface Mount Lamp Unit
 599.001.029
 Spare bulb for E1/E3 24V-5W

	Technical Specification Dimensions:		
	H(mm)	W(mm)	D(mm)
E1	100	100	115
E3	300	100	115



E3 Red/Amber/Green lamp unit
 Heavy Duty IP67 Cast Aluminium Surface Mount Lamp Unit Three 24Vdc lamps:
 Red labelled 'Extinguishing System Operated'

Amber labelled 'Extinguishing System Automatic Control'
 Green labelled 'Extinguishing System Manual Control'

Product Codes

540.007.002
 E3 Red/Amber/Green lamp unit
 599.001.029
 Spare Bulb for E1/E3 24V-5W

DDA Compliant Pager



Fire Tek Pro Paging System

The FireTek Pro paging system is designed for use with professional Fire Systems installed in commercial, industrial and educational premises. The system is primarily designed to alert the "hearing impaired" in the event of a fire or other emergency where an audible sounder is the normal means of indication.

The FireTek Pro has been designed to comply with the recommendations detailed in BS5839-1: 2002 for alerting the "hearing impaired" to the activation of a fire alarm system.

The system can also be used in conjunction with a security panel to alert guards who might be located remotely from the main premises.

The interface to the fire panel comprises of three Prioritised Fire Inputs and two Fault Inputs. For ease of installation, a monitored cable assembly is provided with each system which includes a "common fault" relay output back to the host fire panel. This output will activate if the FireTek Pro suffers a mains failure, transmitter fault, antenna mismatch, interface link failure, or low battery state.

Upon activation of any one of the Fire Inputs, the FireTek Pro will enter the fire alert condition, prioritising and transmitting the Fire message to all enrolled pagers. The transmissions will be repeated until the fire condition is reset. The FireTek Pro Pagers ensure that users are alerted by distinct vibration patterns and clear text messages.

UHF Radio Operation

Any alerting system is only as good as its weakest link. The FireTek Pro utilises UHF radio frequencies, the main benefits being superior in-building radio signal propagation and the option of a manual frequency co-ordinate license issued by OFCOM. Licensing the FireTek Pro provides a higher degree of protection from interference. This fact is acknowledged in Section 18.1 of BS 5839-1:2002.

Features

- UHF radio link for maximum licensable protection
- Unique coding avoids neighbouring system clashes
- Self monitoring of system health
- Rugged steel enclosure to IP65
- Backlit 2 line text display continuously reports system status
- Additional audible & visible status indicators
- Prioritised Fire Alarm Inputs
- Automated test calls alert pagers to loss of radio signal
- Fault Notification to the lost fire panel via a monitored link
- Key operated "System Test" facility for routine confidence checking
- Over 90 hour's backup operation with internal battery
- Achieves Disability Discrimination Act (DDA) compliance

High Integrity Pagers

To complete the system the alphanumeric pagers have added features specifically incorporated for the "hard of hearing" when used with the FireTek Pro. These features include distinct vibrate alerts for emergency messages, a vibrating out of range indicator which displays "No Service" on the pager when the radio link is lost, and a vibrating low battery indicator.

Antenna Options

Mini Dipole Antenna - remote internally mounted antenna for large sites or areas of difficult signal propagation.

Folded Dipole Antenna - remote externally mounted antenna for maximum signal coverage e.g. campuses and multi-building sites.

Chapter 3 - Conventional Systems

Technical Specifications

Supply Voltage:	230V AC 50-60 Hz 12v 7Ah standby battery
Operational Current:	250mA
Inputs:	3 Prioritised Volt Free (Fire) Input 1 - Fire Alarm - Evacuate Building Input 2 - There is an Incident - Leave Building Input 3 - Prepare to Evacuate - Await Instructions 2 Volt Free (Fault)
Outputs:	1 off volt free relay output
Fault Notification:	Mains Failure Transmitter Fault Antenna Mismatch Panel Link Failure Low/Missing Battery
Visual Display:	2 Line Backlit LCD
Enclosure:	Steel Enclosure rated to IP65
Dimensions:	380 x 320 x 110 mm (H x W x D) (No antenna fitted)

Product Codes

557.200.071	Paging Transmitter
557.200.074	40 Character Alpha Numeric Pager
557.200.076	1/2 wave dipole antenna
557.200.077	Wall mounting folded dipole antenna
557.200.078	Pole mounting folded dipole antenna
557.200.079	5 metre antenna feeder cable
557.200.080	10 metre antenna feeder cable

Point Detectors



Features

- Unique early detection enhanced CO fire detector
- Intelligent Universal HPO Smoke Detector
- Low profile, discreet and unobtrusive
- Superior performance and reliability
- Designed for fast, easy installation
- Integral and remote alarm LED
- Series of Product Approvals

Through innovative design the Series 600 detectors have reduced the installation and servicing time to a minimum, needing only one visit to complete the installation and having a park position for the detector to ease the servicing.

The Series 600 detectors include the unique enhanced Carbon Monoxide CO fire detector, which provides a general purpose fire detector with unprecedented early detection capability and excellent false alarm immunity. The CO fire detectors are the first choice for sleeping risks.

Also included within the range is the intelligent high performance optical smoke (HPO) detector. The use of the patented optical sensing chamber, together with refined signal processing, has enabled the introduction of a smoke detector suitable for fast, reliable smoke detection of both slow and fast developing fires.

The HPO can be seen as a truly universal smoke detector, suitable for most applications.

Approvals:-



Chapter 3 - Conventional Systems

High Performance Optical Smoke



These detectors react to the whole range of fire products from slow smouldering fires, producing visible particles to open flaming fires producing large numbers of very hot smaller sized aerosols. It combines optical and heat detector technology to detect clear burning fire products which hitherto could only be easily detected by ion-chamber detectors. For normal ambient conditions, the high performance optical detector behaves as a normal optical detector. Only when a rapid rise in temperature is detected does the sensitivity of the

detector increase and the presence of smoke will confirm a fire condition. The HPO will not operate on a rate of rise of temperature alone.

Datasheet - Product Code PSF123 Manual - Vol 01C-02-D2 "Detectors Fire Manual"

Product Codes

516.600.002

Approval	Model
LPCB	601PH

516.600.202

Approval	Branded	Model
Marine	Tyco	601PH-M

Enhanced Carbon Monoxide Fire



The CO fire detector is a unique general purpose fire detector which provides very early warning of slow smouldering fires. Ideal for sleeping risks the CO fire detector is also well suited to many applications where heat detection is insufficient but smoke detection causes false alarms. As CO travels more freely than smoke the position of CO fire detectors is more flexible.

This feature is particularly useful in large complex structures such as atria and warehouses, where position of smoke detectors is difficult.

Datasheet - Product Code PSF123 Manual - Vol 01C-02-D3 "Detectors Fire Manual"

Product Codes

516.600.004

Approval	Model
LPCB	601CH

516.600.204

Approval	Branded	Model
Marine	Tyco	601CH-M

Optical Smoke



These detectors are capable of detecting the visible smoke produced by materials which smoulder or burn slowly, i.e. soft furnishings, plastic foam etc.; or 'smoke' produced by overheated but unburnt PVC. These detectors are particularly suitable for general applications and areas where cable overheating may occur e.g. electrical services areas. The novel design of the asymmetrical sampling chamber and signal processing techniques stop unwanted alarms caused by very small insects. i.e.

thrips. Smoke entering the sampling chamber scatters the infra-red light pulses onto a photo-diode. These pulses are converted to an electrical signal which is compared against a preset alarm level.

Datasheet - Product Code PSF123 Manual - Vol 01C-02-D6 "Detectors Fire Manual"

Product Codes

516.600.001

Approval	Model
LPCB	601P

516.600.201

Approval	Branded	Model
Marine	Tyco	601P-M

Heat



These detectors use two networked thermistors in a bridge configuration to provide a fast response, that depends both on absolute temperature and notes the change of temperature. The rate of rise/fixed temperature heat detectors can be used in areas where smoke sensors are unsuitable due to environmental conditions (smoke, dust etc.). Such areas include kitchens, locker rooms, canteens, garages, loading bays etc.

Rate of Rise

Product Codes

516.600.003

Approval	Model
LPCB	601H-R

516.600.203

Approval	Branded	Model
Marine	Tyco	601H-R-M

Fixed Temperature 60°C

Product Code

516.600.214

Approval	Model
LPCB/Marine	611H-F

Fixed Temperature 90°C

Product Code

516.600.033

Approval	Model
LPCB/Marine	631H-F

Datasheet - Product Code PSF123 Manual - Vol 01C-02-D5 "Detectors Fire Manual"

Ion Chamber Smoke



These detectors react to the visible and invisible fire aerosols (products of combustion) and are therefore capable of detecting the early presence of hot smouldering and flaming fires, such as wood, paper etc.

They are particularly suitable for general applications in all areas and use a dual ionisation chamber in which the air is ionised by a single radioactive source (33k Bq Americium 241). The presence of smoke in the sampling chamber causes a change in the balance voltage, between the two chambers.

This is then compared against an alarm level.

Datasheet - Product Code PSF123 Manual - Vol 01C-02-D4 "Detectors Fire Manual"

Product Code

516.600.005

Approval
LPCB

Model
6011

Solar Blind Infra Red Flame Detector



Flame detectors, unlike smoke and heat detectors, do not rely on convection to transport the fire product to the detector, nor do they rely on a ceiling to trap the products. They can therefore, be used to protect large open areas without sacrificing speed of response to flaming fires. In order to ensure full coverage, however, flame detectors do require direct line of sight to all parts of the protected area. Infra-red flame detectors such as the 601F are designed to respond

rapidly to fires which involve clean-burning fuels such as alcohol or methane, ie fires which would not be detected by smoke detectors. The 601F Flame detector, by virtue of it's operating wavelength and flicker discrimination, is insensitive to normal environmental influences. For outdoor use, a solar-blind detector (e.g. the S200Plus) should be used. The 601F flame detector should, normally, only be used inside buildings to supplement heat and smoke detectors.

Product Codes

516.600.006

601F

516.600.007

601F-M Marine

Datasheet - Product Code PSF132 Manual - Vol 01C-02-D9 "Detectors Fire Manual"

Chapter 3 - Conventional Systems

Series 600 Detector Specifications

Dimensions of Smoke/Heat/Co Detector

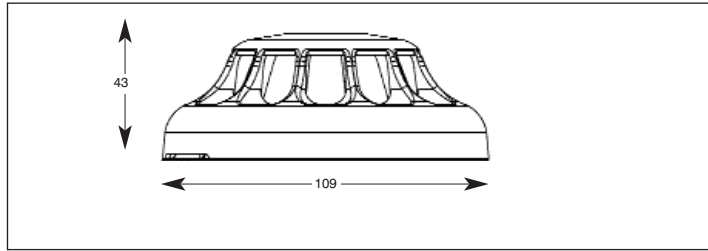

Dimensions of Flame Detector

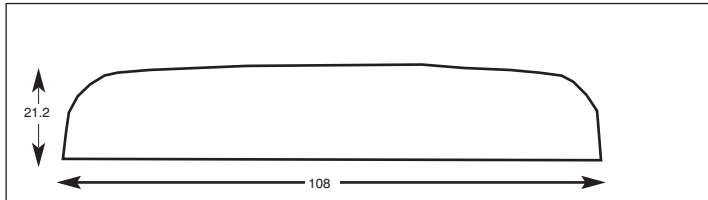

Technical Specification - Series 600

	601I	601PH/P/601PH-M/601P-M	601H-R/611H-F/601H-R-M/631H-F	601CH/601CH-M	601F/601F-M
Weight	100g	93g	80g	90g	74g
Material	FR 110 Bayblend				
Operating Temp.	-20 to +70°C	-20 to +70°C	-20 to +70°C*	-10 to +55°C	-20 to +70°C
Storage Temp.	-40 to +80°C	-25 to +80°C	-25 to +80°C	-20 to +55°C	-40 to + 80°C
Relative Humidity	95/98% Non-Condensing				
Quiescent Current(typ)	62µA	65µA	61/65µA	87µA	300µA
Alarm Current(typ)	54mA	45mA	53mA	53mA	42mA
Operating Voltage	10.5 - 33 Vdc	10.5 - 33 Vdc	10.5 - 33 Vdc	10.5 - 33 Vdc	18-28Vdc
*Short Term (<3min) -40 to +120°C					



Features

- Sealed Stainless Steel Construction
- Suitable for use in hazardous areas

T54B - Point Type Heat Detector

Constructed from stainless steel, the T54B is an extremely rugged heat detector that can be used to detect fires in the harshest of environments. The T54B can be used in environments with ambient temperatures up to 200°C and, being hermetically sealed is impervious to most contaminants.

Classified as a simple device, the T54B can be used in Zone 0 areas when connected to a suitable intrinsically safe barrier.

For reliable operation, it is recommended that T54B detectors have set points 20°C or 20% (whichever is higher) above the maximum temperature they will be exposed to in normal operation.

Preferred factory preset temperatures are: 60, 90, 100, 145°C; normally with open contacts.

Technical Specification

Operating voltage @ 0.5A:	240Va.c. to 24Vdc
Switching Current:	5 to 500mA
Contact Resistance:	<1 ohm
Actuating Temp: (factory set)	60 to 240°C
Fixed Temp. only:	Type E
Accuracy:	+ or - 5%
Ambient Temp.:	-40 to +270°C
Relative Humidity:	100% RH
Protection Category:	IP67
Thread Size:	M20 x 1.5mm

Product Codes

516.033.011	T4E60X T54B Point Type heat detector - 60°C
516.033.012	T4E90X T54B Point Type heat detector - 90°C
516.033.013	T4E100X T54B Point Type heat detector - 100°C
516.033.014	T4E145X T54B Point Type heat detector - 145°C

Other temperatures and normally closed contacts are available by request.

Beam Detectors



Features

- Motorised Auto-Aligning
- Up to 4 Detectors per System Controller
- Each Detector configurable from 8m to 100m
- Integral LASER
- Auto-Align Fast Automatic BeamAlignment
- Auto-Optimise Building Movement and Contamination Compensation
- Low Level System Controller
- 20mm Cable Gland Knockouts on System Controller
- 2-wire interface from System Controller to Detector
- Worldwide Approvals including EN54:12 and UL268
- Up to 4 Detectors per System Controller

FIRERAY 5000 Multi Head Auto Aligning Infrared Optical Beam Smoke Detector

The FIRERAY® 5000 motorised, auto aligning infrared optical beam smoke detector can now be installed with up to four detector heads per system, thus saving on installation time and costs. This innovative system has been designed from the ground up to include pioneering technology that fully addresses the needs of the installer and user, both now and in the future.

With its industry leading optics, the FIRERAY 5000 is ideally suited for the protection of large areas where the use of traditional detection technologies would prove to be too difficult and/or costly to install. The FIRERAY 5000 combines an infrared transmitter and receiver in the same discrete unit and operates by projecting a well-defined beam to a reflective prism, which returns the beam to the receiver for analysis. Smoke in the beam path causes a drop in power, which, if below a pre-determined level, results in an alarm signal.

Getting the system operational is simplified by a number of groundbreaking features that combine to make the FIRERAY 5000 the quickest and easiest detector of its type to install. Once the detector heads are connected, using the Easifit First Fix system, an integral LASER, which is aligned along the optical path of the beam, can be activated. This allows the reflective prism to be sighted quickly and with confidence. Once the LASER has been used to coarsely align the beam, the AutoOptimise beam alignment system takes over and automatically steers the beam into the optimum position.

The system can be fully customised, according to local conditions; both alarm thresholds (sensitivity) and time to Alarm/Fault can be set from the ground level System Controller.

Each detector head is independently configurable from 8m through to 100m and has its own individual fire threshold. The System Controller retains one set of Fire and Fault relays that is common to all detectors that are installed.

The FR5000 MultiHead is supplied with one detector head and reflector for single beam operation from 8 to 50 meters. Up to 3 additional detector heads can be added to the controller to enable larger or more complex areas to be protected (Subject to local codes and standards)

Technical Specification

Controller:	202w x 230h x 81d mm 0.9 Kg
Detector:	134w x 135h x 134d mm - 0.5 Kg
Additional detector head	2mA @ 24VDC
Operating Current	
(low power mode):	10mA @ 24VDC
Operating Voltage:	14 to 28VDC
IP Rating:	IP54
Operating Temperature:	-20 to +55°C
Humidity:	93% RH (non condensing) max

Product Codes

516.015.020	FireRay 5000 System (50m)
516.015.021	FR 5000 Detector Head (50m)
516.015.007	FireRay Reflector 100 X 100mm
	4 reflectors are required for distances from 50 to 100m



Features

- Separate Transmitter and Receiver Heads
- Range 5 to 120 metres, configurable per set of Detectors
- Integral Laser Alignment in Receiver
- 2-wire Interface between Controller and Receiver
- Single and Twin Detector options
- Separate Fire and Fault Relays per Detector
- Low Level Controller with LCD display
- Programmable Sensitivity and Fire Threshold
- Automatic Gain Control (AGC) for drift compensation
- First Fix concept for Transmitter, Receiver and Controller
- Multiple cable gland knockouts for ease of wiring
- Optional Transmitter powering from Controller

Fireray® 3000 Optical Beam Smoke Detector

The FIRERAY® 3000 is ideal for applications where line of sight for the IR (infra-red) detection path is narrow and where the building structure uses reflective surfaces. It has also been designed to be aesthetically pleasing and thus can equally suit modern architectural buildings as well as heritage sites, particularly where ornate ceilings exist.

The FIRERAY® 3000 has been designed so that it can be installed by one operator, with its laser assisted alignment method combined with easy to use alignment LED's offering visual feedback. The integrated laser alignment aid can be activated at the controller or at the receiver head.

An additional detector head set (one transmitter & one receiver) can be added to the controller, separate relay contacts are provided for each of the 2 beam sets.

Technical Specification

Dimensions & Weight

Control Unit: 203 x 124 x 71.5mm (W x H x D)
606gms

Transmitter & Receiver: 78 x 77 x 161mm (W x H x D)
207gms

Operating Range: 5 to 120 m

Operating Voltage Range: 12 to 36V DC \pm 10%

Operating Controller Current (with 1 or 2 Receivers): 14mA (constant)

Operating Transmitter Current: 8mA (per transmitter)

Power Down Reset Time: >10 seconds

Fire and Fault Relay Contacts: VFCO 2A @ 30Volts DC resistive

Operating Temp. (non-condensing):

UL - -20°C to +55°C

EN54 - -10°C to +55°C

IP Rating: IP54

Relative Humidity (non-condensing): 93%

Product Codes

516.015.030 Fireray3000 Optical beam detector

516.015.031 FireRay3000 Extra beam set

FireRay Optical Beam Smoke Detector Mounting Accessories

There are a range of mounting accessories available for use with FireRay® Optical Beam Smoke Detectors. These accessories will help reduce installation times and provide a professional mounting solution when faced with challenging building internals.



The Universal Mounting bracket can be used with the Fireray 5000 detector head and the 1 or 4 way prism plates to enable the detector head or prism plates to be easily mounted and adjusted when fixing to angled walls or cladding

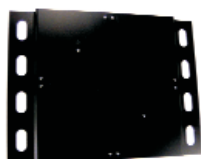

The Flat Mounting plate is a metal plate which will support a single prism or 4 prisms, the side mounting holes are compatible with Unistrut® racking systems.



Adjustable bracket for use with the Fireray 3000 heads or Fireray 5000 head.



The large prism plate will securely mount 4 prisms and is designed to be used in conjunction with the Universal Mounting Bracket (not included)

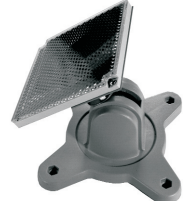

The small prism plate will securely mount a single prism and is designed to be used in conjunction with the Universal Mounting Bracket (not included)

Product Codes

5000-005 Universal Mounting Bracket
5000-006 Flat Mounting Plate for 1 to 4 Prisms
5000-007 Prism Mounting Plate for 4 Prisms
5000-008 Prism Mounting Plate for 1 Prism
3000-201 FireRay3000 adjustable bracket

Linear Heat Detectors



Features

- Easy and cost effective installation
- Good sensitivity with adjustable alarm threshold
- Open and short circuit monitoring
- Suited for outdoor and indoor applications
- Can be used in hazardous areas
- Mechanical protection is provided for cables in areas where damage may occur
- Chemical resistance sheathing is available for areas where petro-chemical corrosion may occur.

Linear Heat Detection

The LD40 linear heat detection system is used to monitor fire (or overheat) conditions in confined or polluted areas or where there are adverse or unusually variable environmental conditions.

The sensor cable is unaffected by dust, moisture or vibration and requires little maintenance.

Technical Specification

Dimensions:	178H x 130W x 75D mm
Weight:	0.55Kg
Operating Temp:	-25°C to +70°C
Relative humidity:	Up to 98% RH non-condensing
Rating:	IP55
Operating Voltage:	+8 to +30Vdc
Quiescent Current:	60-80µA

Product Codes

516.016.005	LD40 High resistance sensor cable blue - 200M reel
516.016.006	LD40 High resistance sensor cable black - 200M reel (Nylon sheath suitable for petrochemical exposure)
516.016.010	LD40 EOL Termination kit (PK10)
516.016.011	LD40 In-line Jointing kit (PK10)
516.016.012	LD40 Analyser module with conventional detection zone interface.
516.016.201	B6782-003 EDGE CLIP 2-3mm WEB
516.016.202	B6782-024 EDGE CLIP 3-8mm WEB
516.016.203	B6782-025 EDGE CLIP 8-13mm WEB
516.016.204	B6782-026 EDGE CLIP 14-20mm WEB
516.016.205	B6782-004 'T' CLIP
516.016.206	B6782-005 PIPE CLIP
516.016.207	B6782-023 'V' CLIP
516.016.208	B6782-008 NEOPRENE SLEEVE



Ceiling Clip

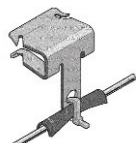

Edge Clip



Pipe Clip

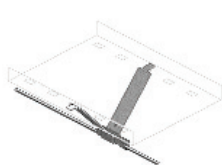

V Clip

Detector Bases and Accessories



Features

- Optional relay bases
- Remote indication LEDs
- Optional conduit entry backboxes
- Protective wire cages

Detector Bases and Ancillaries

The 600 Series range of low profile detectors provide a comprehensive range of highly effective and aesthetically pleasing smoke and heat detectors with worldwide approvals.

The unique design and leading edge technology of the detectors go beyond the detection technology itself. The range of detector bases is designed to make low profile detector installations cost effective, aesthetically pleasing and easy to install and maintain – thus minimising disruption.

The detector bases include standard universal bases, which have no integral electronics, thus making them low cost and low maintenance. Alternatively, a range of functional bases incorporate sounders and relays to provide a cost effective method of adding functions and flexibility to the fire detection installation.

Standard Detector Bases

The standard universal detector bases are compatible with the Series 600 low profile detectors. The standard bases have no electronics and even when the detectors are connected to the bases, they can be electrically disconnected and left in a 'park' position. This enables wiring integrity tests to take place without any damage to electronics. An optional, tool removable locking pin allows the detector to be fixed in place to prevent tampering.

4B 4" Detector Base



The new 4B 4" detector base is designed to snap-fit to the ceiling tile adaptor or it can be screw fixed to a ceiling in the traditional manner.

Features

- Drives a remote indicator
- Detector locking pin provided with every base
- Snap fits to the Time Saver Ceiling Tile Adaptor
- Fits directly to a British or European electrical back box
- Temporary park position
- Break-outs for surface mount

Product Code

517.050.041
4B 4" Detector Base

4B-D 4" Diode Continuity Base



The 4B-D Continuity Base is a standard 4 inch base fitted with a continuity diode, for use with all Series 600 detectors. The base is designed to ensure that conventional systems meet the requirements of BS5839 Pt:1 for callpoints placed after detectors.

Features

- Compatible with Series 600 Low Profile Detector Range
- Designed for two wire operation
- Facility to drive a remote indicator
- A breakout locking key is provided as an integral part of each base, which can be fitted to lock the detector into position.
- A temporary park position is provided so that the field wiring can be tested with the detector in situ.
- Maybe fitted directly to a British or European conduit box or directly onto the ceiling

Product Code

517.050.045
4B-D 4" Diode Continuity Base

Ceiling Tile Adapter



The Time Saver Ceiling Tile Adaptor is used with the 4" snap fit base and consists of three parts, a bezel and clamp that are fitted to the ceiling tile and a back-box that carries the detector and base assembly. It is available as a complete unit or alternatively, the back-box can be ordered separately, as can the bezel and clamp assembly. Ordering the parts separately may be preferred if there is an extended period before the false ceiling is installed e.g. "shell and core" projects. Requires a 127mm diameter hole. The CTA adaptor plate allows the Time Saver Ceiling Tile Adaptor to be used with other devices such as the 601 and 602 sounder bases.

Features

- Cuts installation time by 30%
- Commission the system before the suspended ceiling is installed
- Suitable for ceiling tiles from 1mm to 30mm thick
- Made from flame retardant material
- No additional back-box is required
- Time saver is designed for use with a new snap-fit 4" detector base
- Adaptor available for use with the 601 and 602 sounder bases.

Product Codes

517.050.060
Ceiling Tile Adaptor Kit consists of 1 x 517.050.056 and 1 x 517.050.057
517.050.056
CTA-BB CTA Back Box
517.050.057
CTA-BC CTA Bezel and Clamp
517.050.058
CTA-AP CTA Adaptor Plate

4B-6A 4" to 6" Adaptor



The 4B-6A 4" to 6" Adaptor is designed for use with U.S. style 6" electrical back boxes and provides a flush architectural trim between the electrical box and the 4B-C 4" continuity base. It can also be fixed directly to a ceiling and used to conceal marks left when older, large diameter detectors are replaced with MZX Technology.

Features

- Adapts 6" electrical boxes to fit the 4B-C 4" continuity base
- Architectural trim for neat appearance
- Concealed fixings
- Use to conceal marks left by old detectors when replaced by MZX Technology

Product Code

517.050.054
4B-6A 4" to 6" Base Adaptor

Functional Detector Bases

Functional detector bases use a common moulding which incorporates a double sided circuit board which enables electrical connections to be made on the top and bottom of the functional base. This allows the functional bases to be retrofitted into new and existing universal bases or alternatively the depth and cost of the installed detector can be reduced by using the functional base instead of the universal base.

This feature enables additional sounders to be easily added during commissioning. In addition, changes to the building during it's life can be easily adapted to, by retrofitting sounders and relay outputs to existing detection points. When functional bases are fitted to universal bases, they automatically lock into position. Removal is then achieved using the detector removal tool. This feature ensures that the detector and functional bases are removed separately.

Manual - Vol 01B-09-D1/01B-07-D1 "Detectors Fire Manual"

Tyco MKII Sounder Base



A new low current range of sounder bases for use with Conventional Fire Alarm Control Panels.

Features

- Manufactured to EN54 part 3
- Integral sounder and detector base
- Volume and tone adjustable after installation
- Low Power Synchronisation
- Do not require use of a standard base (maybe installed directly onto a standard besa box)

Product Codes

577.001.035
601SB Conventional Sounder Base
577.001.037
601SBD Conventional Diode Sounder Base
577.001.036
602SB 2 Wire Line Powered Sounder Base
577.001.038
602SBD 2 Wire Line Powered Diode Sounder Base
517.050.022
Volume Pot Spare Cover (1 sheet of 144)

517.050.005

4" Detector Base Locking Pin Kit (PK100)

Tyco MKII Sounder Cap



A plastic cap which fits onto the 601SB/601SBD/602SB/602SBD Sounder Base to enable these bases to operate as a sounder without fitting a detector.

Product Codes

557.001.040.A
Mark II Sounder Cap (ADT Branded)
557.001.040.Y
Mark II Sounder Cap (Tyco Branded)

MC600 Functional Relay Base



The 600 Series relay base provides dual relay contacts for signalling external devices on conventional detection systems. Very low operating current even when the relay is energised, enable the relay base to be used without additional power. The relay contacts operate when the detector enters the alarm condition.

Features

- Dual pole 24Vdc relay contact (60VA)
- Status indicator LED
- Low power consumption (<20µA except start up)
- Latching operation
- Can be used instead of a standard base
- Requires diode fitting if used in place of a diode base.

Technical Specification

Operating Temp: -25°C to +70°C
Humidity: Up to 95% RH (non-condensing)
Vibration: Exceeds requirements of EN54-3, Marine & UL268

Product Code

568.001.018
MC600 Relay base (BS5839)

Volume Adjustment Tool



A simple Volume Adjustment Tool, specific to the task of sounder volume selection on the "variable-volume" range of Tyco MKII Sounder Bases.

Sounder volume can be easily varied between the maximum 90dBA and minimum 68dBA volume settings, using this simple, functional tool.

Product Code

517.050.015
Volume Adjustment Tool

Note: Sounder Bases are supplied with the volume pre-set to maximum volume.

Detector Base Ancillaries

Remote Indication LED



All detector bases have the ability to drive a remote LED in the event that the installed position of the detector is not easily visible.

Features

- UK Single gang mounting
- High intensity red LED

Product Code

540.003.006
Remote LED

4B-EM 4" Euro Mount



The euro-mounting base provides a matching back box, which allows the 4" bases to be ceiling mounted with conduit entries for standard 18 and 21mm conduit.

Features

- 2 x 18mm conduit entries
- 2 x 21mm conduit entries
- Fits all 4" Bases
- Accepts up to 8 accessory terminals

Product Codes

517.050.052
4B-EM 4" Euro Mount

517.050.612
Base Accessory terminal kit
(pack of 10)

4B-DHM Deck Head Mounting

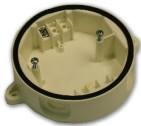

Where the detectors are mounted in humid and environmentally challenging situations such as marine or offshore installations, the 4B-DHM deck head mount provides a sealed waterproof mounting which protects the electrical connections in the base. Can be screwed, bolted / welded to the deckhead. Supplied with 1 terminal. If more are required,

use the optional base accessory terminal kit.

Features

- 4 x 20mm gland entries
- Fits ALL 4" bases
- IP55 with supplied gasket

Product Codes

517.050.051
4B-DHM Deckhead Mount

517.050.612
Base accessory terminal kit
(pack of 10)

Protective Detector Cage



Robust steel protective cage for Series 600 detectors using the 5" base. Ideal for schools and sporthalls or whenever detectors need protection.

Strong coated steel construction with 4 point fitting.

Product Code

517.050.614
CW-5B Detector Cage

Protective Detector/Sounder Base Cage



White powder coated steel protective cage for Series 600 Detectors fitted with a sounder base. Internal dimensions: 120mm dia x 80mm deep.

Product Code

517.050.011
Steel Protective Detector Cage

Duct Probes

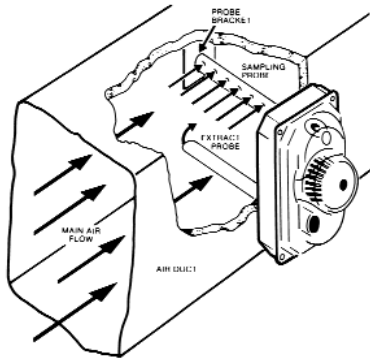

Warning

Duct probe units sited in the common duct work to several extract grills may fail to respond to smoke from any one extract due to the effect of dilution. The SMP units will not respond to airflow of less than 1.5m/sec.

Technical Specification

Operating temperature: -20°C to +70°C
 Storage temperature: -25°C to +80°C
 Relative Humidity: 0 to 95%
 SMP69 Stainless steel 316 housing with transparent polycarbonate cover

SMP Duct Probe Units

Where smoke within duct work needs to be detected these duct probe units provide an economical solution, for use with series 600 detectors.

The SMP Duct Probe Units are designed to be installed in air conditioning supply and exhaust ducts for the purpose of monitoring the airflow for smoke and combustion products.

The SMP69 probe units are designed to accept and operate with series 600 detectors. For general applications it is recommended that photoelectric smoke detectors rather than ionisation smoke detectors are used.

The SMP stainless steel probe unit is designed to withstand the more demanding environments of the offshore oil and gas industries.

The units are designed to operate in airspeeds of 1.5 to 25 metres per second. A range of sampling tubes from 525mm to 1575mm are available.

SMP69	
Height	90mm
Width	150mm
Length	225mm
Weight	1.2Kg

SMP69 Duct Probe Air Sampling - Stainless Steel



Product Codes

517.025.035

SMP69 Stainless Steel Duct Probe unit and universal detector base for Series 600/800 Detectors.

517.025.028

DPS450 Probe tube stainless steel 450mm and exhaust

517.025.029

DPS600 Probe tube stainless steel 600mm and exhaust

517.025.030

DPS750 Probe tube stainless steel 750mm and exhaust

517.025.031

DPS900 Probe tube stainless steel 900mm and exhaust

517.025.032

DPS1200 Probe tube stainless steel 1200mm and exhaust

517.025.033

DPS1500 Probe tube stainless steel 1500mm and exhaust

[Datasheet - Product Code PSF092 "SMP69 Duct Probe Unit"](#)

[Manual - Vol 01B-06-D1 "Detectors Fire Manual"](#)



DPK4 Duct Probe

The DPK4 duct probe unit has been developed to detect smoke in ventilation ducts. It offers significant benefits in terms of performance and installation.

The system comprises a single duct probe tube and housing specially designed for optimum airflow through the smoke detector and suitable for use in incoming, outgoing and circulation air ducts of ventilation and conditioning systems.

The duct probes can operate across a wide range of airflow speeds and are especially recommended for installations in ducts with air flow velocities between 1 m/s and 20 m/s.

Unlike more traditional duct probe units that employ an inlet and exhaust tube with sampling holes, the DPK4 unit uses a highly efficient single sampling tube that is slotted along its length. This allows the sampling tubes to be cut to the desired length whilst maintaining maximum efficiency.

Features

- Built-in MZX Detector base
- DPK4 - with built-in MZX detector base 5" - 5B
- DPK4 is suitable for conventional systems
- Suitable for air velocities from 1 m/s to 20 m/s
- Can be used in combination with a wide range of optical smoke detectors e.g. 601P or 601PH
- One-pipe air sampling system simplifies installation
- Range of aluminium probe tubes are available for ducts up to 2700 mm
- Transparent lid allows detector to be seen
- Test hole on cover
- Sensitive flow indicator
- Simple service and maintenance
- Installer friendly connection of cables
- Easy installation of duct probe tubes

The transparent cover gives clear visibility of the detector, its LED indication and airflow indicator. A red plastic flag is fixed inside the housing providing a simple but effective confirmation that there is no leakage and that the air flow from the air duct is in fact passing through the housing.

In order to reduce the time required to test the duct probe detector during routine maintenance, an aperture is provided that allows aerosol test gas to be directed at the detector without having to dismantle the unit.

Accessories

Tyco Fire Protection Products offer 3 lengths of the duct probe tubes. The tube is made of aluminium and can easily be shortened to suit the span of the air duct. Where the unit is mounted on insulated or circular air ducts, the DPKM mounting bracket is required.

Product Codes

517.025.049	DPK4 - Duct Probe with MZX detector base 5" - 5B
517.025.051	DPK600 - Duct Probe Tube 600 mm
517.025.052	DPK1500 - Duct Probe Tube 1500 mm
517.025.053	DPK2800 - Duct Probe Tube 2800 mm
517.025.054	DPKM - Duct Probe Mounting Bracket
517.025.055	Spare Filters for DPK4/DPK4I (Pk 10)

Detector supplied separately

Callpoints

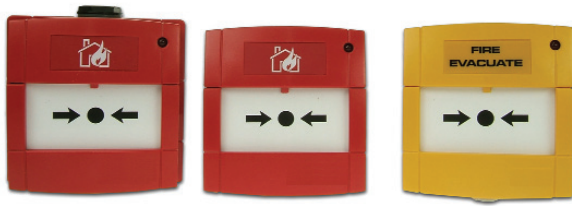

Features

- Integral LED indicator for easy identification of operation
- Surface or flush mounting
- Extensive range of conventional callpoints
- Test key facility, speeds maintenance visits
- Optional transparent hinged cover
- Hazardous areas models available (See Special Hazards Section)
- IP67 Waterproof models for external applications

MCP Series Callpoints

A comprehensive range of callpoints for use with conventional systems. All the callpoints are designed to enable an alarm signal to be given by breaking a glass element.

This operates a switch and is indicated by an LED indicator. If required, an optional transparent hinged cover may be installed to guard against accidental operation.

Technical Specification

(Indoor & Outdoor)

Housing:	PC/ABS
Operating Temp:	
Outdoor	-30°C TO +70°C
Indoor	-10°C TO +55°C
Relative Humidity:	up to 95% RH (non-condensing)

Commonly Used Callpoints

Model	Colour	Type	IP Rating	R4/R1 Ohms
MCP200	Red	Conventional Alert	24D	120/470
MCP210	Red	Conventional Evacuate	24D	47/39
MCP230	Red	Conventional Alert	67	120/470
MCP270	Yellow	Conventional Evacuate	24D	47/39
Keyswitch	White	Conventional	24D	Not Applicable

Indoor & Outdoor MCP Callpoint

Indoor Callpoint

Weight: 110g

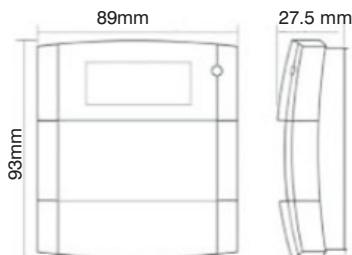

Outdoor Callpoint

Weight: 240g

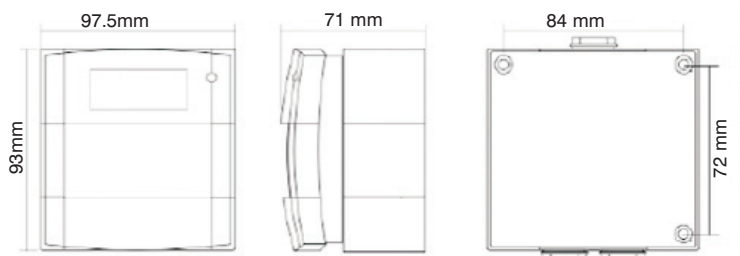

Chapter 3 - Conventional Systems

Conventional MCP200 Callpoint



The MCP200 is a red indoor callpoint with 'alert' resistors and LED indicator. The MCP200 is LPCB approved.

Product Codes

514.001.142.A
MCP200 without backbox-ADT branded
514.001.142.T
MCP200 without backbox - Thorn branded
514.001.142.Y
MCP200 without backbox - Tyco branded

Conventional MCP210/MCP211 Callpoint



The MCP210 is a red indoor callpoint with LED indicator and evacuate resistors. The MCP210 is LPCB approved and is supplied without a backbox.

Product Codes

514.001.143.A
MCP210 ADT branded
514.001.143.T
MCP210 Thorn branded

514.001.143.Y
MCP210 Tyco branded

The MCP211 is a red indoor callpoint with evacuate resistors and LED indicator. (For use with the MZX-c Panels only).

514.001.160.Y
MCP211 Without backbox - Tyco branded
514.001.160.A
MCP211 Without backbox - ADT branded
514.001.160.T
MCP211 Without backbox - Thorn branded

Conventional MCP230 Callpoint



The MCP230 is a IP67 red outdoor callpoint with 'alert' resistors and LED indicator and is LPCB approved.

Product Codes

514.001.110.A
MCP230 ADT branded
514.001.110.T
MCP230 Thorn branded

514.001.110.Y
MCP230 Tyco branded

Conventional MCP270 Callpoint



Product Code

514.001.114
MCP270 Yellow callpoint 'Evacuate' complete with LED indicator and backbox - LPCB approved

Other Conventional Callpoints & Keyswitches



Product Code

514.002.002.A
White keyswitch in callpoint housing. English 'Bomb Alert' marking with ADT branded

Special Marine Callpoints



Product Codes

514.001.112
MCP260M Marine callpoint complete with LED indicator - IP67

514.001.113
MCP250M Marine callpoint complete with LED indicator without back box

Chapter 3 - Conventional Systems

Callpoint Ancillaries



Product Codes
90-107

Red M141 spacer for red MCP KAC callpoints



515.001.045

Test key for all MCP and CP style callpoints



515.001.128

Callpoint hinged cover for use with MCP & CP style callpoint models (Colour - Clear)

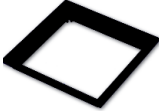

515.001.026

Black callpoint bezel for MCP KAC callpoints

Ancillaries - Back Boxes

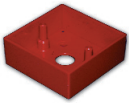

Product Codes

515.001.021

Standard Red surface mounting back box for MCP & CP indoor callpoints

Unless stated the indoor callpoints are supplied as flush mount units. The range is approved for use with the standard backbox. However, the SR2-T backbox is also available.

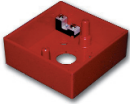

10-115

SR2-T Optional Back Box (2 terminals) for MCP & CP indoor callpoints

Chapter 3 - Conventional Systems

Callpoint Spare Glasses - Current



Product Codes

515.001.119
EN54 Part 11 Spare Glass for MCP and CP series Callpoints (Pack of 5)

515.001.025
CP200 Glasses, clear English text on white background. No logo (Pack of 5).

515.001.127
Deformable operating unit "glass" for use in place of glasses, for kitchens or other areas where glass is not acceptable. For MCP callpoints only.

515.001.024
CP200 spare glasses, black Arabic/English text with Thorn Security logo on white background (Pack of 5)

515.001.014
CP200 Spare glasses, black Arabic text on a white background (Pack of 5)

515.001.023
CP200 Spare glasses for CP200 white dutch text on clear background (Pack of 5)

Callpoint Spare Glasses - Old

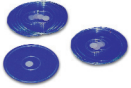

Product Codes

515.001.010
Walsall callpoint glasses (Pack of 10) for service spares. The Walsall callpoint is an old square callpoint with round glass



515.001.003
ZF121 Callpoint glass (Pack 10) for service spares. The ZF121 is a square metal fronted AFA MINERVA callpoint typically used on Firefinder, System 1100, ZF/System 1200, CP and CT systems



515.001.009
CP100A glass unscored (Pack 10) for service spares. The CP100A has a large square glass to the edge of the callpoint. Used on the same AFA systems as the ZF121.

Features

- Prevents accidental operation of callpoints
- Strong polycarbonate construction
- Optional break seal kit



STOPPER

The callpoint STOPPER provides protection from malicious or accidental activation of manual callpoints. Available for flush or surface mounted callpoints the 'STOPPER' is also available with optional high pitch sounder which is activated when the lid is lifted. An optional 'Break-Seal' fitting kit allows 'Break-Seals' to be used to provide extra protection.

WARNING:- Break seals should only be fitted by agreement with relevant fire authorities.

The STOPPER is suitable for all callpoints up to 100mm square, including the MCP200 and other indoor KAC style callpoints.

Product Code	Ref	STOPPER		STOPPER II	With Sounder	Weatherproof
		Flush	Surface			
515.001.029	STI6530	✓				
515.001.030	STI6531		✓			
515.001.036	STI6535		✓			✓
515.001.034	STI1230			✓		
515.001.035	STI3150			✓		✓
515.001.031	STI6532	✓			✓	
515.001.032	STI6533		✓		✓	

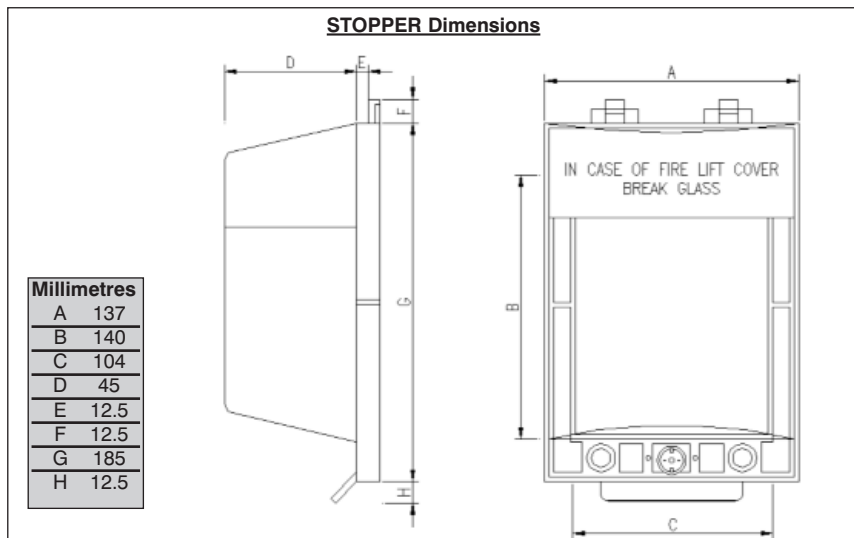

Product Code

515.001.033

IPO36 Break Seal Kit (pack of 1)

	Flush Fit	Surface Fit (+30mm)
Stopper	STI6530	STI6531
Stopper with Sounder	STI6532	STI6533

	STOPPER	STOPPER II
Max. Callpoint Size	100 x 100mm	160 x 160 mm
Max. Callpoint Depth	57.5	120
	(+30mm Surface)	

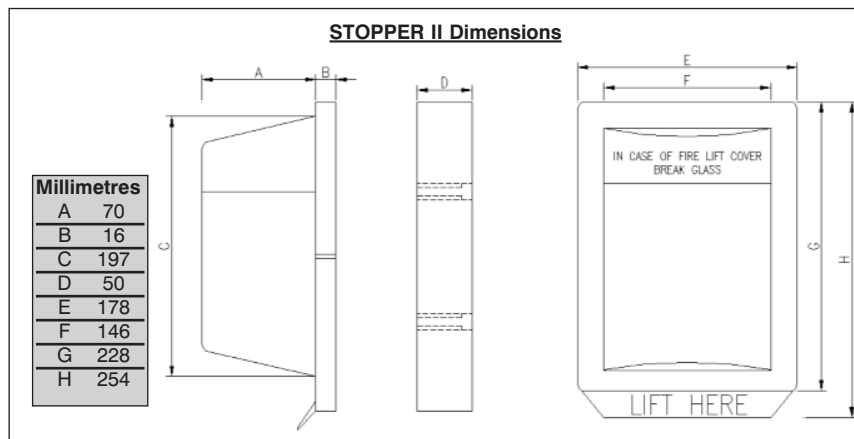

Stopper II Surface Fit - STI1230



Features

- Strong polycarbonate construction
- Tamper resistant

STOPPER II

The STOPPER II is constructed as the STOPPER from tough injection moulded polycarbonate. Physically larger than the STOPPER the STOPPER II extends the number of products to which these tough multi-purpose covers can protect.

It consists of a strong tamper-proof clear polycarbonate cover and frame that fits easily over such products as break glass callpoints.

STOPPER II can also be fitted with an integral battery powered sounder which activates if the cover is lifted.

The STOPPER II is suitable for callpoints up to 160mm square.

Product Code

515.001.034 STI1230 Surface fit STOPPER II



Features

- Strong polycarbonate construction
- Provides environmental protection
- Ideal for offshore environments

Weather STOPPER & Weather STOPPER II

The Weather STOPPER and Weather STOPPER II extends the life of weather exposed devices, such as break glass callpoints, by offering protection against harsh conditions and environments. Experience has shown that this protective cover can extend the life of products installed in saline atmospheres, such as oil rigs and ship decks.

While offering environmental protection the Weather STOPPER and Weather STOPPER II are constructed from tough durable polycarbonate which will also guard against tampering, vandalism or accidental operation of devices such as emergency switches.

Product Codes

515.001.036 STI6535 Surface fit Weather STOPPER
515.001.035 STI3150 Surface fit Weather STOPPER II

Chapter 3 - Conventional Systems

Smoke Beam/CCTV Guard



The Smoke Beam/CCTV Guard is manufactured from tough coated steel rod and is designed to protect projected beam detectors or CCTV cameras from vandalism or accidental damage.

Suitable for use with System Sensor, Hochiki and FireRay 2000 detectors.

Technical Specification

Dimensions: 260H x 200W x 321D mm

Product Code

516.015.009

STI9625 Smoke beam/CCTV guard

Keybox



This tough polycarbonate breakglass keybox is available to protect emergency keys.

Product Code

515.001.043

STI6720 Keybox with printed glass

Sounders and Beacons



Features

- Wide range of both bells and electronic sounders
- High sound output characteristics
- Low current consumption
- Clean lines, modern styling
- Easy to install, low installation costs
- Weatherproof units for outdoor use
- Distinct sounds are available
- Motorised and Solenoid bells available
- Wide range of voltages available

Sounders

A range of sounders to meet a wide variety of alarm applications where loud, penetrating and distinctive warnings must be given to alert people of fire situations.

In addition, multitone electronic sounders can give a variety of sounds to signal other conditions e.g. "extinguishing gas release imminent," etc.

Note: For I.S. & Flameproof sounders, please see the special hazards section.

Bells



Features

- CE marked
- Low current 6" bell (ONLY 11mA)
- Low cost
- Extra high 95dBA/m
- Slim profile (53mm)
- Fully suppressed and polarised
- Quick and easy to install
- LPCB approved to EN54 Pt 3

6" & 8" Motorised Bells

Model	MBF-6EV	MBF-8EV	MBA 8EV
Rated Voltage	24V d.c.	24V d.c.	24V d.c.
Rated Current	11mA	17mA	18mA
Sound output	90-95dBA	90-97dBA	91-97dBA
Operating Temp	-12 to +50°C		-10 to +50°C
Colour	Red		
Weight	410g	640g	1100g with back box

Product Codes

576.501.039.A	MBF-6EV ADT Branded
576.501.039.T	MBF-6EV Thorn Branded
576.501.040.A	MBF-8EV ADT Branded
576.501.044.A	MBA-8EV ADT Branded
576.501.044.T	MBA-8EV Thorn Branded
576.501.045	BBX4 (2) W/P Backbox for MBA-8 Bell



Features

- Weatherproof Option
- Flexible Mounting Option
- Attractive Design

Electronic Solenoid Bell

Unique patented alarm bell with miniature solenoid and integrated electronic control. No backbox required for surface wiring.

Technical Specification

Dimensions:	6" diameter
Voltage:	18-30Vdc
Typical Current:	30mA @ 24Vdc
Typ. Sound Output:	94dB (A) @ 1m

Product Codes

20-100	6" 24Vdc Electronic bell, weatherproof IP33C - Wormald Branded
20-101	6" 24Vdc Electronic bell - red IP21C - Wormald Branded
20-111	6" 24Vdc Electronic bell - white IP21C

Marine Approved Products

576.501.407	MED 6" 24Vdc Electronic bell, weatherproof - red IP33C
576.501.408	MED 6" 24Vdc Electronic bell-red IP21C



Features

- Low Current Consumption
- Suppressed and Polarised
- Sturdy Construction

CF Motorised Bell

The CF Motorised Bell is low current, fully suppressed and polarised.

Technical Specification

Dimensions:	6" Diameter
Colour:	Red
Output Voltage:	20-28Vdc
Typical Current:	25mA @ 24Vdc
Typical Sound Output:	95dB (A) @ 1m

Product Code

Marine Approved Product

576.501.405	MED 6" Red 24Vdc Motorised bell, "Fire" text with Thorn Branding
-------------	--

Electronic Sounders



Features

- Modern aesthetic design
- 32 Selectable tones
- 3 Volume settings
- Push and twist mount
- Shallow and deep bases
- Available in red or white
- Low current consumption
- 2 Stage alarm available
- Independently switched sounder or beacon
- Xenon beacon with the Excel Lite

Banshee Excel Sounders

The Banshee Excel sounder replaces the Banshee Multi Tone range of Sounders. It uses the same technically superior rocking arm transducer to reproduce the familiar 32 tones of the previous Banshee and Bedlam ranges.

Technical Specification

Approvals:	VdS approved to EN54-3
Tones available:	32
Operating voltage:	9-30Vdc
Tone current consumption:	See Tone Table in Chapter 11
Flash current consumption:	40mA
Operating temperature range (Deg C):	-40 to +70
Volume control via DIL switch:	Maximum, Medium (-10dBA), Low (-20dBA)
Flash rate per second:	1
Ingress Protection:	IP45 or IP66
Termination:	Screw terminals for 028mm ² to 2.5mm ² wire conductor

Banshee Excel Lite Sounder Beacon

The new Banshee Excel adds the Banshee Excel Lite Sounder Beacon to its range using a high output xenon with the familiar sounder. The Banshee Excel Lite can be used as a multi stage device by switching the beacon and the sounder independently using a third wire.

Product Codes

576.501.060	Banshee Excel sounder, red, IP45 (replaces 576.501.005.A & 576.501.005.T)
576.501.061	Banshee Excel sounder, white, IP45 (replaces 576.501.009 & 576.501.025.A)
576.501.062	Banshee Excel sounder, red, IP66 (replaces 576.501.016.A & 576.501.016.T)
576.501.063	Banshee Excel Lite, red sounder, red xenon beacon, IP45

Chapter 3 - Conventional Systems

Accessories



The combined mounting bracket for the Besson Multi-tone Banshee and Xenon Beacon allows quick and neat installation of combined sounders and beacons. The bracket allows the following electronic sounders to be mounted with the range of 1W Xenon Beacons:

- Besson Banshee
- MINERVA FIRECRYER voice enhanced sounder

The bracket can be used with any of the 24Vd.c 1W Xenon beacons in red, clear, amber or blue (Part no.'s 540.001.030/031/032 & 033)

Product Code

576.501.047

Banshee/Xenon bracket

Besson Wafer Sounder



The standard Besson Wafer sounder is supplied in white with a blank cover included. The specification is as follows:
Input voltage: 24V d.c. (+/-25%)
Sound Output: 60dBA/90dBA at 1m typical (pot. Adjustable) offering the same sound formats as the Banshee sounder range. It can therefore be used in conjunction with the Banshee sounders on the same site.

Technical Specification

Current: 4mA to 15mA
Temperature Range: -40°C to + 70°C
Dimensions: Dia 103mm, Height 22mm (excluding coverplate)

Product Code

576.501.038

Besson wafer sounder and blank cover in white

Flush Mount Bedroom Sounder



Meeting the requirements for BS5839 part 1, the Bedroom Sounder range is well suited to hotels and residential environments where aesthetics is a prime concern. Matching the sound output of the Banshee range of sounders so therefore they can be mixed on the same site.

Features

- Low current consumption 7mA
- Dual sound options selected via a jumper switch: 'Continuous' and 'Fast Sweep' 90dB
- Can be both Flush and Surface mounted
- Robust terminal connectors to accommodate up to 2.5mm² conductors

Product Codes

576.501.032.A

Flush Mount Sounder ADT Branded

576.501.032.T

Flush Mount Sounder Thorn Branded

Yodalarms

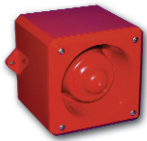

This versatile range of sounders are ideally suited for fire, safety and security hazard warning.

Technical Specification

Dimensions:
YO3: 89H x 89W x 85D mm
YO5: 134H x 134W x 128D mm
YO8: 216H x 216W x 153D mm

Product Codes

576.501.001

YO3 Yodalarm 3" 24Vdc 100dB @ 1Mtr

576.501.002

YO5 Yodalarm 5" 24Vdc 106dB @ 1Mtr

576.501.003

YO8 Yodalarm 8" 24Vdc 112dB @ 1Mtr

Chapter 3 - Conventional Systems

MZX-c 2 Wire Symphoni Sounder



A Symphoni electronic sounder designed specifically for installation on the detection zone of the MZX-c panel

Technical Specification

Sound Output @ 1M: 100dB(A) +/-2dB(A) @ 24Vdc
 Tones: Continuous - 970Hz
 Alternating - 970/800 Hz at 2 Hz
 Pulsed - 970 Hz at 1Hz
 Operating Temp: -25 to +70 C
 Construction: Red/White ABS
 Ingress Protection: IP21C
 Termination: 2.5mm² Screw Terminals

Product Codes

576.501.204
 Symphoni 2 Wire Sounder (Red)
 576.501.205
 Symphoni 2 Wire Sounder (White)

24Vdc Symphoni Sounder



The 24Vdc Symphoni Sounder is a general purpose internal sounder, available either as a very high output sounder for noisy areas, or a high output low current sounder for applications where power is limited. Both versions share the same horn and backbox which has double cable entries for ease of installation.

The low power version has 3 selectable tones which may be employed for one, two or three stage alarm applications. The high output version has 32 selectable tones and retains full tone compatibility with the Roshni, Squashni and Askari product ranges.

Product Codes

576.501.200
 SY/R Low Power Red Symphoni Sounder (3 tone)
 576.501.201
 SY/W Low Power White Symphoni Sounder (3 tone)
 576.501.202
 SYHO/R High Output Red Symphoni Sounder (32 tone)
 576.501.203
 SYHO/W High Output White Symphoni Sounder (32 tone)

Technical Specification

Model	Symphoni High Output	Symphoni (Low Power)
Operation	2 Hours Continuous	Continuous
Operating Voltage Range	9-28Vdc	12-30Vdc
Sound Output @ 1m	Up to 120dB(A)	100dB(A) +/- 2dB(A) @ 24Vd. c.
Volume Control		Down to 80dB approx.
Current Consumption	240mA +/- 20mA on Tone 3	5mA +/- 1mA at all volumes
Tones	1 to 32	Alternating 990Hz/650Hz@ 2Hz Continuous 990Hz Intermittent 990Hz, On/Off @ 1Hz
Synchronisation	Synchronised Start	Synchronised Start
Frequency Stability	+/- 0.15%	+/- 0.5%
Operating Temperature	-25 °C to + 55°C	-25°C to +70°C
Line Monitoring Method	Polarised Input	Polarised Input
Construction	ABS Plastic Case	ABS Plastic Case
Ingress Protection	IP21C	IP21C
Weight	0.58Kg	0.212Kg

Roshni



A flexible alarm sounder for Fire and Security applications complete with volume control and dil switch to provide 32 tones.

Low profile Roshni with Deep base offers IP65 protection. All Roshni sounders have synchronised start for self synchronisation without third wire.

Technical Specification

Dimensions: 93 Dia x 105D mm (Deep base)
 Colour: Red or white
 Output Voltage: 9-28Vdc
 Typical Current: 16mA @ 24Vdc
 Typ. Sound Output: 102dB @ 1m

Product Codes

ROSHRDSR
 ROSHNI Sounder c/w deep base - red
 576.501.220
 ROSHNI Sounder c/w shallow base - red
 576.501.221
 ROSHNI Sounder c/w shallow base - white
 576.501.222
 ROSHNI/Flashni Deep Base - Red
 576.501.223
 ROSHNI/Flashni Deep Base - White
Marine Approved Products
 576.501.401
 MED W/P ROSHNI Sounder c/w deep base-red
 576.501.402
 MED ROSHNI Sounder c/w shallow base-red

Squashni



The Squashni electronic sounder is the original ceiling sounder for use as a universal fire detector platform or as a stand alone sounder complete with blank cover. It comes preset to tone 3 with a volume control and is fully compatible with Roshni tones, and has a synchronised start.

Technical Specification

Dimensions: 112 Dia x 27D mm
Colour: Matched to leading fire detector manufacturers
Approvals: None
Output Voltage: 9-28Vdc
Typical Current: 24Vdc@16mA
Typ. Sound Output: @1m 93dB (A)

Product Codes

576.501.030
Squashni white 24Vdc
576.501.031
Blank cover plate white for Squashni

Multi-Tone Askari Compact



The Multi-Tone Askari Compact is a compact bedroom sounder for unobtrusive installation. It comes with a volume control and is fully compatible with Roshni tones and has a synchronised start. A surface mount backbox is available from the supplier to special order.

Technical Specification

Dimensions: 87.5H x 87.5W x 36D mm
Colour: Red or white
Approvals: BS 5839 pt 1
Input Voltage: 9-28Vdc
Typ. Current: 18mA @ 24Vdc
Typ. Sound Output: 97dB (A) @1m

Product Codes

576.501.242
Multi Tone Askari Compact Sounder - white
576.501.243
Multi Tone Askari Compact Sounder - red



Features

- Single Message or Multiple Message using the same sounder
- Multi Message facilitates multi evacuation strategies
- Clear and unambiguous alarm messages
- Voice Alarm Messages provoke an immediate response
- Sound Output – Up to 100db(A) (Fire-Cryer® Plus), 90db(A) (Mini Fire-Cryer® Plus), 110db(A) (Midi Fire-Cryer® Plus)
- Optional integral Red Strobe
- Low current consumption – average 20mA
- No special wiring easily retro fitted
- Fully synchronised over multi zones
- Deep base version available to IP66
- Ultra slim base sounder to fit industry standard detectors
- Suitable for ceiling or wall mounting (Mini Fire-Cryer® Plus)
- Optional front plate for stand alone use (Mini Fire-Cryer® Plus)
- Voice Message Controller makes manual message switching easy

Fire-Cryer Plus® - Voice Enhanced Sounders

The Fire-Cryer® Plus range of voice sounders are electronic sounders which are pre-programmed with 9 messages. Each of the Fire-Cryer® voice sounders can be used as a single message voice sounder by simply installing them on to a conventional 24Vdc sounder circuit or by using a sounder controller on a loop. The choice of message(s) broadcast can be selected using a DIL switch on the rear of the sounder. **See Table A**

The Fire-Cryer® Plus offers an excellent service upgrade opportunity for systems as well as a highly flexible and cost effective solution to providing a voice evacuation system to many buildings. The choice of Fire-Cryer® voice sounders can be selected using **Table B**

Messages 1 to 7 in **Table A** can be used in a multi message installation with the addition of a Multi Message Switching PCB (576.501.171) or a Voice Message Controller (576.501.181 or 576.501.182) interfaced between the fire alarm control panel and the sounder circuits. The Voice Message Controllers can be supplied with a 2.5A or 5.25A power supply built in. A Zone Extension PCB (576.501.172) is available to extend the system to 4 zones or 8 sounder circuits. **See Table C**

A special Extinguishing PCB (576.501.173) used with the 576.501.135 will enable 1st, 2nd Stage, 'Hold' and 'Gas Released' messages to be automatically broadcast dependent on the state of the alarm. **See Table A1**

Chapter 3 - Conventional Systems

Fire-Cryer® Plus Multi Message PCB

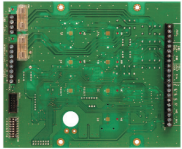

Product Code
576.501.171 Fire-Cryer® Plus Multi Message PCB

Fire-Cryer® Plus Zone Extension PCB

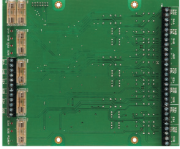

Product Code
576.501.172 Fire-Cryer® Plus Zone Extension PCB

Fire-Cryer® Plus Extinguishing PCB

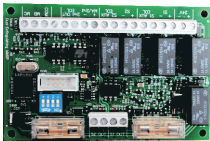

Product Code
576.501.173 Fire-Cryer® Plus Extinguishing PCB

Din Rail Mounting Kit for Fire-Cryer® Plus Extinguishing PCB



Product Code
557.201.303 Din Rail Mounting Kit

IP66 Housing for Fire-Cryer® Plus Extinguishing PCB



Product Code
557.201.410 IP66 Housing

VMC / Multi Message PCB and 2.5A PSU



Product Code
576.501.181 VMC / Multi Message PCB and 2.5A PSU

VMC / Multi Message / Zone Extension PCB and 5.25A PSU



Product Code
576.501.182 VMC / Multi Message / Zone Extension PCB and 5.25A PSU

Chapter 3 - Conventional Systems

Technical Specification

Fire-Cryer® Plus Model	Fire-Cryer® Plus	Mini	Midi
VDC Operating Voltage	20-28	20-28	20-28
Current mA @ 24VDC Peak/Avg - Sounder only	27/20	27/20	180/100
Current mA @ 24VDC Typical: Sounder with low current strobe	33/26	n/a	n/a
Current mA @ 24VDC Typical: Sounder with high current strobe	52/60	n/a	n/a
Current mA @ 24VDC Low current strobe only	13	n/a	n/a
Current mA @ 24VDC High current strobe only	32	n/a	n/a
Strobe Output Cd (LOW)	2	n/a	n/a
Strobe Output Cd (HIGH)	6	n/a	n/a
Volume Adjustment from Max. dBA Output to max output -18dBA	82 to 100	72 to 90	101 to 110
Weatherproofing (IP66 requires Deep Base)	IP45 or IP66	n/a	IP44
Housing Material	ABS	ABS	Aluminium/ Plastic Base
Temperature Range °C	-25 to +70	-10 to +55	-25 to +70
Colour	Red or White	White	Red
Connections	Screw TB 1.5mm ²	Screw TB 1.5mm ²	Clamp 2.5mm ²

Figure 1 - Direct Connection to FACP

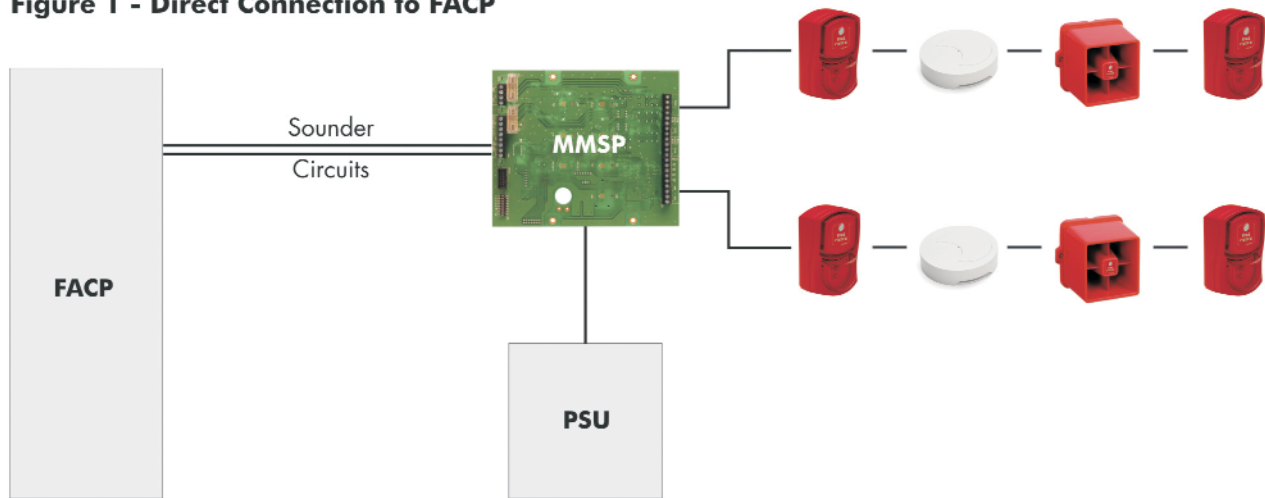
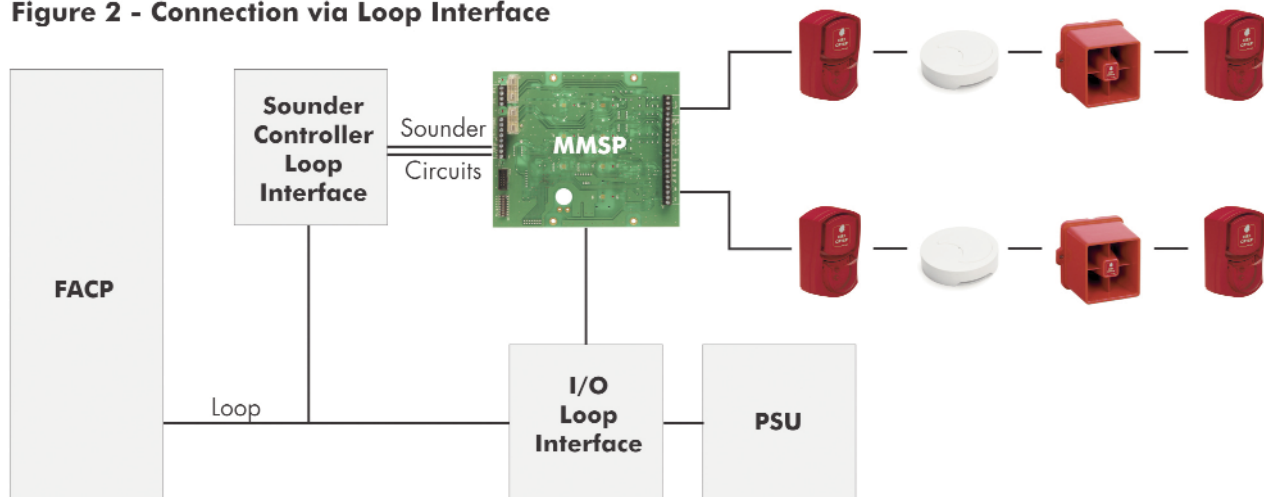

Figure 2 - Connection via Loop Interface



Chapter 3 - Conventional Systems

Standard Message Set which consists of 9 pre-programmed messages with tones (See Table A)

When used as a Multi Message sounder DIL Switches 4, 5, 6, 7 and 8 are OFF. When used as a single message sounder use the DIL Switch settings in the table below 1 = ON, 0 = OFF

When used as a Multi Message Sounder the Multi Message Switching PCB (576.501.171) will assign the messages to the following triggers:

Table A

	Starting Tone (See Table (A2) below)	Two Letter Message Code	Beacon Flashes Y/N	Speech Message		SW4	SW5	SW6	SW7	SW8
Message 1	1	AK	Y	Fire emergency. Please remain calm and evacuate the building immediately	S1A/S1B	1	0	0	0	0
Message 2	2	AB	Y	This is a fire alert. This is a fire alert. Await further instructions. Await further instructions.	MA	0	1	0	0	0
Message 3	2	MA	Y	Standby alert. Close all blinds and move to the middle of the room.	MB	1	1	0	0	0
Message 4	0	AD	N	All clear. All clear. No further action required.	MC	0	0	1	0	0
Message 5	0	SP	N	This is an ADT fire test. No action required.	MD	1	0	1	0	0
Message 6	3	CC	N	This is a class change announcement.	ME	0	1	1	0	0
Message 7	1	AF	Y	Fire detected. Keep calm. Leave the building by the nearest exit.	MF	1	1	1	0	0
Message 8	2	AZ	Y	Ladies and gentlemen – due to unforeseen circumstances we must ask you to leave the building immediately by the nearest exit or as directed by members of staff.		0	0	0	1	0
Message 9	2	AX	Y	We have an emergency situation. Please leave the building by the nearest exit. Members of staff will assist you.		1	0	0	1	0

Table A1 GAS EXTINGUISHANT MESSAGES (Used with 576.501.135)

	Starting Tone (See Table (A2) below)	Two Letter Message Code	Beacon Flashes Y/N	Speech Message
1st Stage	2	CG	Y	First stage extinguishant release warning.
2nd Stage	2	CH	Y	Second stage extinguishant release warning.
Hold	0	LU	N	Extinguishant gas release on hold.
Gas Released	1	CJ	Y	Extinguishant released.

Table A2

Tone	
0	No tone
1	Banshee LF Fast Sweep. 800Hz to 950Hz swept @ 9hz
2	Banshee LF Fast Sweep. 800Hz to 950Hz swept @ 9hz Pulsed at 1 second ON, 1 second OFF
3	Bell tone, pulsed

Chapter 3 - Conventional Systems

Ordering Fire-Cryer Plus® Voice Sounders

Step 1 - Choose your Fire-Cryer® Sounder



Table B

Type	Body Colour	Beacon	Base	Part Ref.
Wall Mount	Red	Red	Shallow	576.501.131
			Deep	576.501.132
		None	Shallow	576.501.133
			Deep	576.501.134
Wall Mount	White	Red	Shallow	576.501.141
		None	Shallow	576.501.142
Wall Mount	Red	Red	Shallow	576.501.135
Wall Mount	Red	None	Deep	576.501.151
Base Mount	White	None	n/a	576.501.161

Step 2 - Choose your Interfaces for Multi Message Systems

Table C

Standard Multi Message Switching PCB				576.501.171
Zone Extension PCB (adds 3 Zones of 2 Sounder Circuits i.e. 6 sounder circuits. Must be used with 576.501.171)				576.501.172
Extinguishant Interface PCB				576.501.173
Voice Message Controllers & PSUs (All VMC enclosures include a 576.501.171)				
576.501.171	576.501.172	PSU	Box Size	Part Ref
Yes	No	2.5A	M2	576.501.181
Yes	Yes	5.25A	M3	576.501.182
Box Sizes	M2 Enclosure 385W x 310H x 90D mm			
	M3 Enclosure 385W x 520H x 90D mm			

Product Codes

576.501.131	Standard Fire-Cryer® Plus, red wall mounted, shallow base, red beacon
576.501.132	Standard Fire-Cryer® Plus, red wall mounted, deep base, red beacon
576.501.133	Standard Fire-Cryer® Plus, red, wall mounted, shallow base
576.501.134	Standard Fire-Cryer® Plus, red, wall mounted, deep base
576.501.135	Standard Fire-Cryer® Plus (for use with 576.501.173 in Gas Extinguishant systems)
576.501.141	Standard Fire-Cryer® Plus, white wall mounted, shallow base, red beacon
576.501.142	Standard Fire-Cryer® Plus, white, wall mounted, shallow base
576.501.151	Midi Fire-Cryer® Plus, c/w back box, red
576.501.161	Mini Fire-Cryer® Plus, base mounted, white, c/w cover
576.501.052	Mini Fire-Cryer® Plus, voice enhanced base sounder cable spacing ring
576.501.171	Fire-Cryer® Plus Multi Message PCB
576.501.172	Fire-Cryer® Plus Zone Extension PCB
576.501.173	Fire-Cryer® Plus Extinguishing PCB
557.201.303	Din Rail Mounting Kit for Fire-Cryer® Plus Extinguishing PCB
557.201.410	IP66 Housing for Fire-Cryer® Plus Extinguishing PCB
576.501.181	Voice Message Controller c/w Multi Message PCB and 2.5A PSU
576.501.182	Voice Message Controller c/w Multi Message PCB, Zone Extension PCB and 5.25A PSU
576.501.191	Fire-Cryer® Plus Demo Unit

Beacons

Single Gang Lamp/Buzzer Units



Lamp Buzzer units may be used for local alarms when high level audible warnings may not be appropriate. Available in flush and surface mount versions to fit standard single gang backboxes.

Features

- Low Current
- Flush or Surface Mount
- Hi-Brightness LED

Technical Specification

Dimensions: 90H x 90W
x 40D mm
Current Rating: 15mA at 24Vdc nominally

Product Codes

540.011.012
Single gang flush mount LED (red)/Buzzer Unit labelled 'Fire Alarm'
540.011.013
Single gang surface mount LED (red)/Buzzer Unit labelled 'Fire Alarm' c/w surface backbox.

Solista LED Beacon



Ultra low power requirement 3mA or 6mA at 24Vdc. Long life low profile design. Protected to IP54, supplied complete with base.

Product Code

576.501.230
Solista LED Beacon (Red)

Easy AV™ Retrofit LED Beacon



This low power LED beacon is designed to be retrofitted to existing Banshee electronic sounders. Easy and fast installation typically 3 min. Low power 6mA max at 24Vdc. High Output LEDs.

Product Code

576.501.012
Easy AV strobe for Banshee Sounders

NOTE: For I.S. Flameproof Beacons, please see the special hazards section.



Features

- Available in 1, 2, 3 and 5 watts
- Protected to IP65
- Attractive low profile design
- Optional bracket for mounting both Beacon and Banshee Sounder

Xenon Beacons - 24V Including Surface Mount Adaptor

This high quality range of Xenon beacons are tested to IP 65 making them ideal for the most stringent applications.

Each beacon incorporates a low profile Fresnel lens designed to give maximum light output.

Technical Specification

Voltage Vdc	Power Output Watt(s)	Alarm Current mA	Flash Rate	Rating	Temp. Range	Dimensions (mm)	
						Height	Diameter
24	1	42	60/min	IP65	-30 to +70°C	51	75
24	2	84	60/min	IP65	-30 to +70°C	51	75
24	3	126	60/min	IP65	-30 to +70°C	51	75
24	5	210	60/min	IP65	-30 to +70°C	75	90

Product Codes

540.001.030	Low profile clear 24Vdc 1 watt
540.001.031	Low profile blue 24Vdc 1 watt
540.001.032	Low profile amber 24Vdc 1 watt
540.001.033	Low profile red 24Vdc 1 watt
20-112	Low profile red 24Vdc 2 watt
20-113	Low profile red 24Vdc 5 watt
20-120	Low profile red 24Vdc 3 watt



Solex 10 cd Xenon Beacon

A Solex 10 Candela Xenon Beacon with a red lens and a white shallow base which can be used wherever a high power xenon beacon is required.

Features

- High Power – 10 Candela
- Current Surge Suppression
- High Efficiency – 88mA at 24VDC
- 1 Hz Flash Rate
- Protected to IP54
- Wide Operating Voltage – 10 to 60 VDC
- Operating Temperature -25°C to + 70°C

Due to the high power output and current consumption it is recommended that this device is not used with the MZX-c, MZX-c+ or similar small panels (an SB520 sounder booster module and PSU may be required in some cases).

Product Code

576.501.232	Solex 10 cd Beacon with red lens and white base
-------------	---



Features

- Combined strobe & sounder
- Matches Roshni sounders
- Weather Resistant to IP65

Flashni - Sounder/Strobe

A combined sounder and beacon which combines the features of the Roshni electronic sounder with a fully integrated Xenon beacon.

These sounders are fully compatible with all Roshni tones.

Technical Specification

Dimensions:	93 Dia x 92D mm (Shallow base)
	93 Dia x 121D mm (Deep base)
Input Voltage:	18-30Vdc
Typical Current:	68mA@24Vdc
Typ. Sound Output:	101dB (A)@1m

Product Codes

20-118	Combined Roshni sounder/strobe complete with deep base (IP65).
576.501.224	Combined Roshni Sounder/Strobe, Red Body/Red Lens complete with shallow base & tone switch.
576.501.227	Combined Roshni Sounder/Strobe, Red Body/Red Lens, deep base, tone switch & separate sounder/strobe operation.

Marine Approved Product

576.501.403	MED Combined Roshni Sounder/Strobe, Red Body/Red Lens complete with shallow base
-------------	--



Squashni G3/AV Sounder Beacon

This low current combined sounder/beacon is ideal for standalone usage utilising the optional blanking cap or can be used in conjunction with a 4" base and detector. When used with a detector it will provide a single point of installation for the detector, sounder and beacon.

Features

- Combined Sounder and LED Beacon
- Low Current -10mA @ 24VDC
- 6 selectable tones
- Volume control (2 levels)
- White housing, clear lens with red LED's
- DDA compliant audio visual solution for UK
- Neat unobtrusive design
- Ideal for hotels, care homes, schools & offices
- Independent power cables allow a large number of AV platform sounders to be driven from a single 24V circuit
- 90dB sound output
- >1Cd light output at 1 Hz
- Approved to EN54-3

This is a conventional sounder / beacon and needs to be powered from the panel sounder outputs.

Product Codes

576.501.250	Squashni G3/AV Sounder Beacon
576.501.255	Squashni G3/AV Blanking Cap – Pack of 5
517.050.041	4B 4" Detector Base
517.050.045	4B-D 4" Diode Continuity Base



Features

- 2 Wire for use with MZX-c Fire Controllers
- Combined Sounder and LED Beacon
- Low Current
- 4 selectable tones
- Volume control (2 levels)
- Beacon Only option (switchable)
- White housing, clear lens with red LED's
- DDA compliant audio visual solution for UK
- Neat unobtrusive design
- Ideal for hotels, offices, care homes, schools & offices
- 90dB sound output
- >1Cd Light output at 1 Hz
- Maximum number per zone = 10

Squashni G3/AV 2 Wire Sounder Beacon - (Twin Wire)

This low current combined sounder beacon is designed specifically for installation on the detection loop of the MZX-c control panel. Ideal for standalone usage utilising the optional blanking cap or can be used in conjunction with a 4" base and detector.

When used with a detector it will provide a single point of installation for the detector, sounder and beacon.

This is a 2 wire sounder/beacon and can be used on all zones of the MZX-c control panel.

Product Codes

576.501.251	Squashni G3/AV 2 Wire Sounder Beacon
576.501.255	Squashni G3/AV Blanking Cap – Pack of 5
517.050.041	4B 4" Detector Base
517.050.045	4B-D 4" Diode Continuity Base

Service & Spares

T1200 CONVENTIONAL MARINE PANEL

C1626 4 ZONE PANEL MOTHERBOARD WITH AC PSU (509.023.001)
C1626 4 ZONE PANEL MOTHERBOARD WITHOUT AC PSU (509.023.002)
C1627 16 ZONE PANEL MOTHERBOARD WITHOUT AC PSU (509.023.003)
C1627 16 ZONE PANEL MOTHERBOARD WITHOUT AC PSU FOR T1232 (509.023.004)
C1626 REPEATER MOTHERBOARD WITH AC PSU (509.023.011)
C1626 REPEATER MOTHERBOARD WITHOUT AC PSU (509.023.012)
C1628 4 ZONE PANEL DISPLAY PCB (509.023.021)
C1628 16 ZONE PANEL DISPLAY PCB (509.023.022)
C1629 32 ZONE PANEL DISPLAY PCB (509.023.023)
C1628 16 ZONE REPEATER DISPLAY PCB (509.023.031)
C1629 32 ZONE REPEATER DISPLAY PCB (509.023.032)
C1630 OUTPUT EXPANSION INTERFACE PCB (2605060)
C1632 16 ZONE PANEL EXPANSION PCB (509.023.042)
PS136 5.0 AMP 110/230VAC PSU (509.023.051)
PS40 1.5 AMP 24VDC PSU (509.023.052)
T1200 & T1200-C SPARE KEY SET (509.023.061)

MZX-c CONVENTIONAL PANEL

2 ZONE 2 WIRE MZX-c MOTHERBOARD (2605508)
4 ZONE 2 WIRE MZX-c MOTHERBOARD (2605509)
8 ZONE 2 WIRE MZX-c MOTHERBOARD (2605510)
MZX-c MOTHERBOARD 8 ZONE REPEATER (2605505)
MZX-c POWER SUPPLY (BAQ35T-24)
MZX-c SPARE ENABLE KEY (2501061)
MZX-c ZONE EOL UNIT - PK5 (2605538)

MZX-c+ CONVENTIONAL PANEL

MZX-c+ SPARE KEY SET (557.201.508)
MZX-c+ 5.0 AMP PSU - C1652 (2605071)
MZX-c+ TRANSFORMER 1.5 AMP (2000636)
MZX-c+ TRANSFORMER 3.0 AMP (2000637)
MZX-c+ TRANSFORMER 5.0 AMP (2000638)

MZX-e EXTINGUISHING PANEL

MZX-e SPARE KEY SET (557.201.508)

EXTINGUISHING ANCILLARIES

LAMP 28V 60mA (MCC) FOR T525 (599.001.012)
24V5WSBC SP BULB FOR E1/E3 (599.001.029)

MANUAL ALARM CALLPOINTS

ZF121 CALLPOINT GLASS (PK10) (515.001.003)
CP100A CALLPOINT GLASS UNSCORED (PK10) (515.001.009)
WALSALL CALLPOINT GLASS (PK10) (515.001.010)
CP200 CALLPOINT GLASS-ARABIC (PK5) (515.001.014)
CP200N CALLPOINT GLASS (PK5) (515.001.023)
CP200 CALLPOINT ARABIC/ENGLISH GLASS (PK5) (515.001.024)
CP200 CALLPOINT ENGLISH GLASS NO LOGO (PK5) (515.001.025)
STOPPER BREAK SEAL KIT-RED (PK1) (515.001.033)
MCP/CP CALLPOINT TEST KEY (PK1) (515.001.045)
MCP/CP CALLPOINT EN54 PT11 SPARE GLASS (PK5) (515.001.119)
DEFORMABLE MCP ELEMENT (PK1) (515.001.127)

Tyco Expert Graphics (TXG)



Features

- Provides annunciation, status display, and control in both normal and emergency situations
- Developed by Tyco specifically to provide monitoring and control of fire protection life safety systems
- Supports a range of fire detection systems:-
 - Minerva® MX and MZX Minerva® Simplex 4100 range 4100, 4120, 4020, 4100U with upgrade paths to 2120
 - Zettler Zetfas, Wormald PBS16, Tyco Fast 2000
- Multiple workstations can be configured for specific functions or redundant operation
- Single monitor or two monitor (text and graphics) support at each workstation

Emergency Management System & Fire Detection Graphical User Interface

Tyco Expert Graphics is a new client/server emergency management system and fire detection graphical user interface.

TXG is based on a Tyco graphical alarm monitoring system that has been installed on hundreds of large fire detection and alarm monitoring systems around the world and offers the ability to integrate all Fire Panels with MZX technology, such as Minerva MX, MZX500 series and Zettler ZX, with improved functionalities

Tyco Expert Graphics provides annunciation, status display, and control for various fire detection and alarm systems including MX networks incorporating the latest MZX Technology™ fire detection systems. It also supports the predecessor Minerva® fire detection systems thus ensuring that future updates from Minerva® to MX technology™ can be accommodated. Additional support is provided for Simplex 4100 range, Zetfas and Fast2000\PBS (Token ring format).

TXG is a Microsoft Windows® based graphical interface with a high resolution colour display. Responsive touch-screen (optional) buttons with realistic icons and keyboard provide control switches specific to the operation being performed. Utilising a combination of symbols, floor plans, pictures, text, voice messages and video input, TXG displays the precise location and gives instructions on what emergency action should be taken.

Additional Features

- Link up with I.P. CCTV camera systems, no additional wiring, reduced installation cost for a fully integrated fire\CCTV system
- Compatible with Flamevision® FV300 array based IR flame detectors with built in CCTV
- MX Hotspot, chromatic analogue display. Programmable tracking of analogue values. Changes display colour in response to changes in analogue value from a selected number of MX devices.
- Trending diagrams of analogue values helps reduce maintenance time and cost
- Export analogue values to Excel for in depth analysis
- Audio descriptions of screens can be played when they are displayed or played when an event occurs

The display can be configured to track detector inputs by changing the colour of areas in response to changes in analogue value. A detailed map of the area affected can be printed automatically for use by personnel responding to an emergency. Prompt response to a fire emergency, with the correct action, provides the opportunity to reduce financial loss and greatly improves safety.

Much of the work involved in configuring TXG has been simplified through the automatic import of panel configurations, AutoCAD® graphics, including data points, and the ability to use a wide range of input data file types including GIF, JPG, bitmap, Vector and WAV files.

System maintenance can be carried out via the high level user interface with the ability to edit the position and attributes of point icons as well as make changes to drawing layouts. As well as simplifying maintenance, being a true client server application means that any number of on-site or off-site workstations can interrogate the database with pre-defined security levels to facilitate any required combination of access and control.

- High level user interface allows end user to make changes to point attributes and layout further reducing lifetime cost of ownership.
- Centralised security administration means that operator accounts are administered through the TXG client's common database
- Mouse, keyboard or touch-screen control with full multimedia compatibility
- Dual language switching
- The ability to display live video when specific predefined alarm conditions occur
- Easy to configure and set-up. No special networking or PC training required
- Facilities and maintenance management report and analysis tools are available

Chapter 4 - Networks and Graphics

The IP Video feature allows real-time images of the area at risk to be displayed in the event of an alarm or fault. Video capture of the affected area appears on the screen automatically, allowing the severity of the situation to be assessed quickly and the appropriate executive action to be taken.

For less serious incidents, expensive and unnecessary plant shut downs can be avoided. In more critical situations, accurate information can be quickly and efficiently communicated to the response team.

MX HOTSPOT Icons representing the devices being monitored will change colour dependant on status, alarm, normal, fault, isolate etc.

In addition to this, selected areas can be highlighted using the chromatic analogue display feature, MX HOTSPOT. As the analogue value of a monitored point changes the chromatic analogue display will change the highlight colour through a pre-defined range.

For example a heat detector assigned MX HOTSPOT could transit the highlight from blue to red. The number of chromatic steps is dependent on the resolution of the graphics card used, 16, 24 or 32 bits

NOTIFICATION BY EMAIL

Events, whether they are real or false alarms are handled most efficiently when information can be quickly and accurately communicated. TXG allows users to set up email groups and notification texts linked to predetermined events.

These are automatically transmitted ensuring that the appropriate resource is deployed.

ADDITIONAL FUNCTIONS AND FEATURES

- Response buttons with configurable icons or text provide control switches specific to any operation being performed
- Uses a combination of symbols, floor plans, pictures, text and video to communicate events
- Standard MX and Minerva® symbol libraries supplied
- Gives instructions on what emergency action should be taken
- Prints maps and instructions to assist response teams
- History logging recallable or printable by event, dates, device, or a host of other available filters
- The advanced filter allows the history report to be specifically limited to a particular range or date period.
- Commands to control outputs from the Graphical User Interface
- Events can be accepted individually or can be “auto-accept”
- Supports all standard PC image file types (i.e. GIF, JPG, BMP), AutoCAD® & Vector file types

AVAILABILITY AND ORDER PROCESS

TXG can be downloaded from the tycoemea.com website and can be used with a time restriction for demonstration or training purposes. TXG can also be ordered from our Letchworth and Echt distribution centres.

Customers can fax or e-Mail an order form which details the software options required, to customer service at Letchworth. Original order forms can be obtained from <http://www.tycoemea.com/>. This form will allow customer service to prepare and allocate a license code that will activate the required features. Customers will also be required to place an order on JDE for each part number on the form.

A media pack containing CD with license number, dongle, multi language manuals on CD and original order form will be dispatched to the customer.

On receipt, the software can be loaded and the license number entered to make available the requested software features.

Product Codes

508.040.100	TXG USB Server Dongle/License/Software
508.040.001	TXG001-Single Client with 1 panel (Requires TXG USB)
508.040.002	TXG004-Single Client with 2 to 4 panels (Requires TXG USB and TXG001)
508.040.003	TXG010-Single Client with 5 to 10 panels (Requires TXG USB, TXG001 and TXG004)
508.040.004	TXG020-Single Client with 11 to 20 panels (RequiresTXG USB, TXG001, TXG004 and TXG010)
508.040.005	TXG999-Single Client with 21 or above panels (Requires TXG USB, TXG001, TXG004 TXG010 and TXG020)
508.040.011	TXG-C Additional Client license
508.040.021	TXG-MIN80 Minerva driver license
508.040.025	TXG-OPC - OPC Alarm / Event & Data Access Server Licence
508.040.027	TXG-CPP - SIMPLEX CPP driver
508.040.033	TXG-PBS/FAST2000 DRIVER
508.020.026	TXG Emergency Management PC (no monitor)
508.020.050	19" LCD Touchscreen Monitor

TXG IS TOTALLY SCALABLE



.....FROM A SINGLE FIRE ALARM PANEL CONNECTED TO A TXG SERVER.....

The modest additional cost of a single TXG client/server is easily justified when the benefits that a Graphical User Interface bring are considered.

TXG with direct connection to a single Minerva® MX

.....TO A COMPLEX INSTALLATION WITH MULTIPLE DIVERSE NETWORKS AND DISTRIBUTED CLIENTS

Large multi-building facilities may have a number of fire detection networks, possibly installed over an extended period of time. TXG can be used as a hub to integrate these systems with a number of clients providing annunciation and control where it is needed.

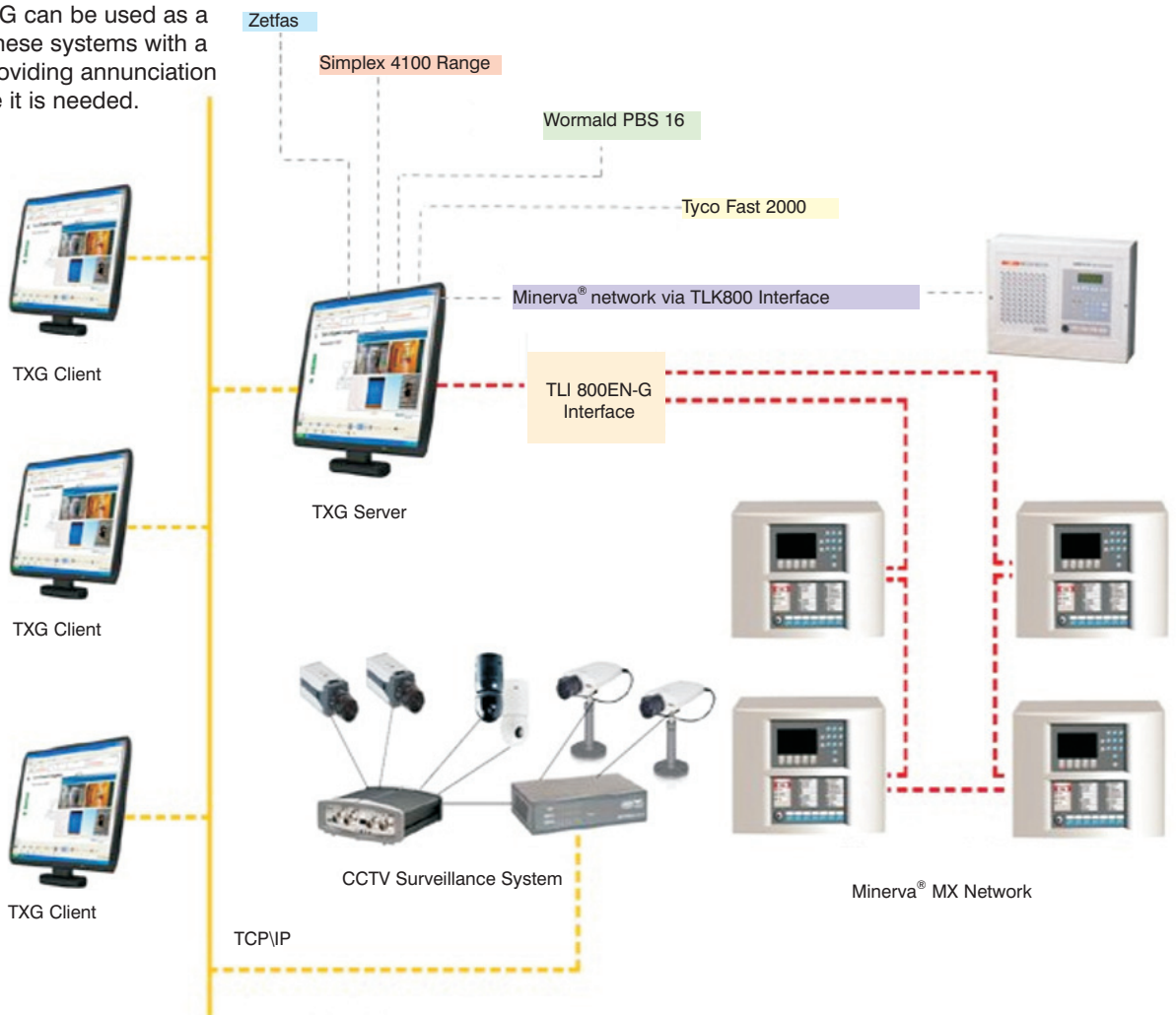

TXG with multiple fire detection networks and CCTV integration

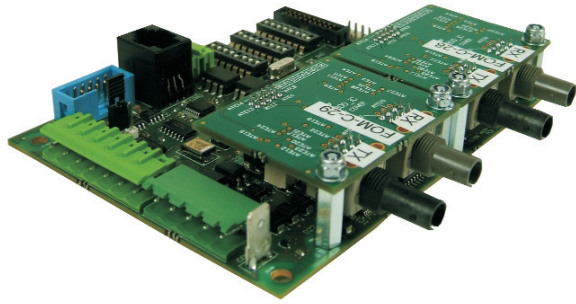

Features

- Allows MZX Technology Fire Controllers to be “seamlessly” networked together
- Dual ARM 7 RISC processors
- Support for Emergency Mode Indication
- True peer-to-peer communications; no host or master controller required
- Highly resilient, node failure open and short circuit does not affect remaining network
- Approved to EN54-13 and EN54-2
- Up to 99 controllers may be used on the network
- Wide range of cable topography supported
- Network can use a variety of cable types with up to 2500m between nodes (cable dependant), 1200m using standard 1.5mm MICC cable
- FOM800 Plug on fibre optic module provides up to 5000m between nodes using 62.5/125 multimode fibres
- Easy to install and programme
- Simple to operate

TLI800EN Network Interface Module and FOM800 Fibre Optic Module

Inter-controller Network

The use of the MZX Technology Network allows the fragmentation of a number of fire controllers to be drawn into a network system. Because every installation is different, the MZX Technology Network has been designed to be highly flexible, allowing for a wide range of different systems applications. With a large network system the amount of data and information passing between fire controllers can become high during an emergency condition. The MZX Technology Network communication protocol has been specifically designed with this in mind and ensures that each event message passed around the network is acknowledged by the receiving controller in the fastest possible time.

Operation

The network is totally flexible and enables from 2 to 99 fire controllers to be seamlessly linked together, providing a system capability of up to 23,760 fire zones with 99,000 detection addresses, and over 100,000 digital I/O points.

System Overview

The MX Net communications network comprises a collection of network interface modules and peripheral equipment that together form a fault resistant, and flexible peer-to-peer network for the MX Digital addressable fire systems controllers.

With the MZX Technology Network, each MZX Fire Controller on the network permits an operator to interrogate and control any other MZX Fire Controller on the network for extended interrogation and control, the MZX Technology Network allows for up to a maximum of five nodes on the network to be configured either as Master operating stations or TXG graphical user interfaces (refer to datasheet PSF206).

Cable Parameters		
Maximum wire to wire capacitance	Resistance	
Baud rate	Capacitance	Maximum resistance = 40 Ohm for EN54-13 compliant installation.
38400	0.3 uF	
19200	0.6 uF	Maximum resistance = 65 Ohm for proper function without compliance.(all baud rates)
9600	1.2 uF	
2400	1.2 uF	
1200	1.2 uF	

Master operating stations use the standard MZX Fire Controller hardware. In this application, the controller changes its personality; and enables additional information from each controller on the network to be displayed.

Mode of Operation

The MZX Technology Network employs a token passing communications protocol that treats each node on the network equally. Loss of one or more nodes does not affect the operation of the remainder of the network.

Data is regenerated at each node in the network enabling maximum distance between nodes. In the event of a short/open circuit on the network between any two nodes, isolation will automatically occur and the network will re-configure communications and continue to allow communication between all nodes physically connected.

The MZX Technology Network offers a high level of system integrity, allowing safety critical actions to be passed across the network from one MZX Fire Controller to another. This very high level of system integrity enables the MZX Technology Network to meet the requirements of EN54-13 and EN54-2.

In the event of loss of communication with the host controller, the TLI800EN will use its secondary processor to monitor the controllers fire outputs and if necessary can activate the controllers emergency fire input. In addition it can support a LED annunciator for network panel fire indication, this is wired to a MPM800 via the TLI800EN's integral RBus RS485 port.

Fibre Optics

Fibre optics can also be supported on the MZX Technology Network system by fitting one or two FOM800 modules to the TLI800EN network card, this uses either type 62.5/125 or 50/125 multi-mode fibres between nodes on the network. Use of fibre permits a maximum distance between nodes of up to 5000 metres in either bus or ring topology.

Product Codes

- | | |
|-------------|---|
| 557.202.080 | TLI800EN Network Card and cable |
| 557.202.081 | FOM800 Fibre Optic Module |
| 557.200.039 | TLI800EN Network Interface in Housing c/w PSU |

Chapter 4 - Networks and Graphics

Technical Specification

TLI800EN Network Card

Mechanical

Dimensions: 116 x 90 x 20 mm
Weight: 0.10 Kg
Housing: The TLI800 Network P.C.B. is mounted directly onto the MZX CPU800 within the panel enclosure

Electrical

Power Consumption: 74mA @ 24VDC & 20mA @ 5VDC
Network Connections: 2 x RS 485
Network diagnostic: 9 x on board LED's / RS232 port for system analysis and fault finding
Cable Type: 2 Core MICC, Shielded or Twisted pair
Network Connections: Screw terminals, will accept 2.5 mm² cable

Network Parameters:

Number of nodes: 99 (max)
Distance between nodes: 1000 to 5000 metres (dependent upon cable type)
Communications type: RS485
Baud Rates: 9.6K to 115.2K
Transport Type: Token passing, non-collision protocol

Environmental

Operating Temp: -10°C to + 55°C
Storage Temp: -10°C to + 70°C
Relative Humidity: 95% (100% intermittent)

Technical Specification

FOM800 Fibre Optic Network Interface

Mechanical

Dimension: 50 x 58 x 12 mm
Weight: 0.015 Kg
Housing: The FOM800 is mounted directly onto the TLI800EN Network card

Electrical

Supply Voltage: Powered from TLI800EN
Network Connections: 2 x ST Fibre optic connections
Cable Type: 62.5/125 or 50/125 multi-mode fibre optic cables

Environmental

Operating Temp: -10°C to + 55°C
Storage Temp: -10°C to + 70°C
Relative Humidity: 95% (100% intermittent)

Technical Specification

TLI800EN-G Housed Network Card with PSU

Mechanical

Dimension: 300 x 200 x 85 mm
Weight: 3.85 Kg

Environmental

Operating Temperature: 0°C to +55°C
Relative Humidity: 95% max

Electrical

Supply Voltage: 220 to 250 VAC
Power consumption: 160mA

TLD-530 ThornNet/MXNet direct line driver PCB



The Telephone Line Driver Module (TLD-530) is used to interface two (2) dedicated telephone line circuits to the TLI-800 module. The TLD-530 line driver module converts the RS-485 signals received from the TLI-800 network interface module to signals capable of being transmitted over the telephone line circuits. One TLI-800 supports two channels so only one module is required per controller for both single path and redundant path star connections. The interface allows for field configured baud rates and supports distances of up 3,000 metres. Up to two units can be fitted into a TLO/TLD Housing.

Technical Specification

Dimensions	170H x 120W x 20D mm
Weight	140g

Product Codes

557.180.699	TLD 530 ThornNet/MXNet direct line driver PCB
557.180.148.A	TLO/TLD Housing - ADT branded

CCU3



The CCU3/C-MXMB provides a MODBUS interface to a number of MX panels on an MXNet. CCU/IO boards may also be connected to provide general I/O devices accessed through the MODBUS interface.

The CCU3/C-MXMB connects to MX panels on the MXNet via a TLI-800 (TPI) interface card using RS232 (PL2 socket). It connects to MODBUS via either an RS232, RS485 (default) or RS422 connection. Another port allows up to 8 CCU/IO boards to be connected. Each CCU/IO has 8 relay outputs that can be used as inputs to the MX. These contacts are controlled via WRITE commands to the MODBUS map. Each CCU/IO also has 8 supervised inputs whose status can be read from the MODBUS map.

Technical Specification

Input Voltage:	18-30Vdc
Current:	150mA at 24Vdc
Dimensions:	140 x 105 x 15mm

Product Code

557.202.046	MX CCU3/C-MXMB MX to MOD Bus Interface
-------------	---



The CCU3/C-MX Bridge enables the direct connection of an MX Technology® fire controller and Minerva® 16E or 80 fire controllers via the H-Bus Communications Driver Module (CDM). No network cards are required in this configuration. The CDM attaches on to the Minerva® H-Bus and provides a serial port for the CCU3/C-MX bridge.

Product Codes

557.202.123	MX Bridge CCU3/C-MX Bridge
557.180.025	Minerva Comms Driver Module

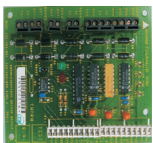



Features

- Facilitates Integration of MX & Minerva Systems
- Easy Upgrade Path for MINERVA systems

MX Minerva - Bridge

The MX Minerva bridge enables a mix of Minerva and MX Panels anywhere on a shared network to operate as an integrated system.

Housed in either a MXAPSU17 or MXAPSU38 housing, the MX-Minerva bridge is a translating host converting packets between the Minerva format and the MX format in both directions. Flexibility is provided for packet conversion in the bridge configuration programme.

The bridge comprises of 2 network cards and a translating host (CCU).

The MX Minerva bridge can be added to one mixed network using both Minerva and MX Nodes or it can be connected to span between two physically separated network rings, one with Minerva nodes and one with MX nodes.

Technical Specification

Size:	320x440x120mm (17A/H) 320x440x215mm (38A/H)
Input voltage:	120-250VAC - 50/60Hz
Operating Temp:	8°C to +55°C
EMC/RFI:	EN50130-4

Product Codes

557.202.120	MX-Minerva Bridge Kit (17A/H)
557.202.121	MX-Minerva Bridge Kit (38A/H)

This page is left intentionally blank

Essential Test Equipment



Testifire is a 3 in 1 tool which represents the next generation of detector testing enabling smoke, heat and CO testing from one device. Latest technology stimuli production and delivery renders the product suitable for testing complex multi sensors to basic single sensor detectors.

Its advanced design allows for single, sequential or simultaneous stimuli generation. This ensures each type of detector can be functionally tested in an efficient manner.

Testifire eliminates the need for pressurised canisters by using replaceable capsules. It addresses global warming concerns associated with aerosols reducing waste and transport bulk.



Smoke, Heat & CO Detector Test Kit



Product Code
517.001.236

- Includes:
- 1 x Testifire Smoke, Heat & CO Detector Tester
 - 1 x Testifire Smoke Capsule
 - 1 x Testifire CO Capsule
 - 2 x Solo Battery Batons
 - 1 x Solo Battery Charger

Smoke Capsules



Product Code
517.001.237

6 x Replacement smoke capsules for use with Testifire

CO Capsules

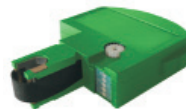

Product Code
517.001.238

6 x Replacement CO capsules for use with Testifire

Detector Removal Tool



Product Code
517.001.240

- Universal Solo design suits wide range of detectors
- Suitable for use at / from angles

800RT Detector Removal Tool



Product Code
516.800.917

- Compatible with 800 and 600 series detectors
- Enables detector dust covers to be removed

Telescopic Access Pole



Product Code
517.001.230

- Solo Telescopic Pole extends from 1.26 to 4.5 metres
- Optimum strength to weight ratio
- Certified non-conductivity
- Simple locking mechanism and easy to use

Extension Pole



Product Code
517.001.226

A 1.13 metre Solo Extension Pole which can be used on its own or fitted to the Solo Telescopic Access Pole

Storage Bag



Product Code
517.001.264

A protective carry and storage bag for the Solo or Testifire product ranges

Chapter 5 - Detector Test Equipment

Adaptor Tube B



Product Code

517.001.224

Adaptor for Solo Access Poles to allow fitting of:
800RT Detector Removal Tool 516.800.917
T110 Flame Detector Tester 592.001.012
T210+ Flame Detector Tester 592.001.016
M900 Address Key Extractor Tool 517.001.235

M900 Address Key Extractor Tool



Product Code

517.001.235

The address key extractor tool can be used to remove the address key from either a 4" or 5" detector base from ground level

Additional and Alternative Products & Accessories

Smoke & Heat Detector Test Kit



Product Code

517.001.267

Includes: 1 x Testifire Smoke & Heat Detector Tester
1 x Testifire Smoke Capsule
2 x Solo Battery Batons
1 x Solo Battery Charger

Dispenser for Solo Smoke and CO Canister



Product Code

517.001.255

- Lightweight and simple to use
- Universal design suits wide range of detectors
- Spring loaded solution for suspended ceilings
- Transparent cup for clear view of detector LED
- Designed for use at height, angles or low level
- For use with Solo Smoke and CO Canisters

Solo Smoke Detector Tester



Product Code

517.001.256

- Designed for use with Solo Dispenser
- Non flammable
- Fast activation
- Fast clearing

Solo CO Detector Tester



Product Code

517.001.262

- Designed for use with Solo Dispenser
- Genuine, non-flammable CO stimulus
- Controlled delivery

Cordless Heat Detector Test Kit



Product Code

517.001.254

- Battery powered
- No cables, trailing leads or hanging wires
- Suits fixed temperature, rate of rise and combination detectors upto 194°F / 90 °C
- Lightweight and simple to use
- Universal design suits wide range of detectors
- Transparent cup for clear view of detector LED
- Designed for use at height, angles or low level

Includes: 1 x Solo Heat Detector Tester
1 x Solo Battery Charger
2 x Solo Battery Batons

Battery Baton



Product Code

517.001.239

NiMH Battery Baton for use with Testifire and Solo Cordless Heat Detector Tester

Battery Charger



Product Code

517.001.243

Fast Charger for use with Solo Battery Batons

Product Selector

Smoke Capsule 517.001.237

Smoke Capsule 517.001.237

CO Capsule 517.001.238

Solo Smoke Detector Tester 517.001.256

Solo CO Detector Tester 517.001.262

Testifire Smoke, Heat & Co Detector Tester 517.001.236

Testifire Smoke & Heat Detector Tester 517.001.267

Solo Smoke & CO Aerosol Dispenser 517.001.255

Solo Heat Detector Tester 517.001.254

Solo Universal Removal Tool 517.001.240

Flame Detector Testers 592.001.012
592.001.016

Detector Removal Tool 516.800.917

Address Key Extractor Tool 517.001.235

Solo Battery Baton 517.001.239
For use with
Smoke, Heat & CO Detector Test Kit 517.001.236
Smoke & Heat Detector Test Kit 517.001.267
Cordless Heat Detector Test Kit 517.001.254

Adapter Tube B
517.001.224

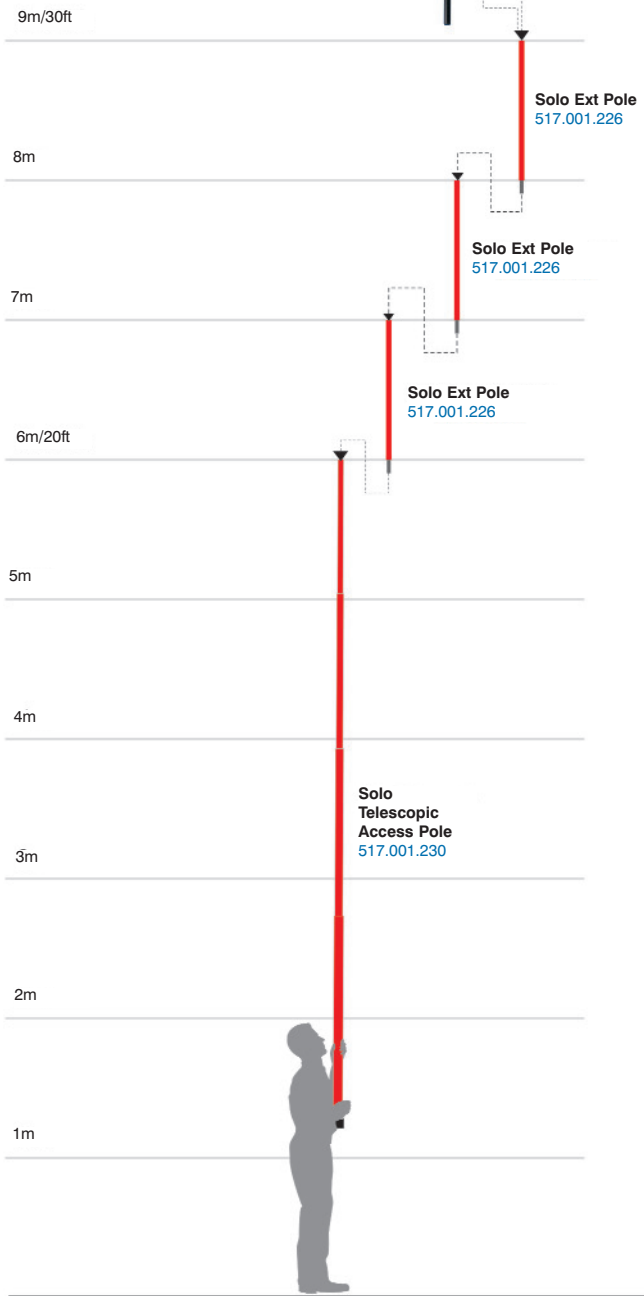

Solo Poles Access Height

Part Numbers	Access Height (approx max.)
517.001.230	6m / 20ft
517.001.230+ 517.001.226 (x1)	7m / 23ft
517.001.230+ 517.001.226 (x2)	8m / 26.25ft
517.001.230+ 517.001.226 (x3)	9m / 30ft

Solo Battery Baton Charger
517.001.243

Solo Carry Bag
517.001.264



Features

- Approved for use in zone 1 & 2 areas (GPIIC gases)
- Adaptor plate to ensure perfect alignment
- IECEX Approved

S200+ Series Test Equipment Technical Specification

Material: Glass filled polyester
Weight: 0.8kg
Supply Voltage: 9Vdc
Operating Temp: -10°C to + 50°C
Humidity: 95% (Non Condensing)
Enclosure: IP54
Classification: Atex EExe ib IICT4. Suitable for use in zones 1 & 2 where group IIC gases or lesser hazards are sometimes present in explosive concentrations.

Product Codes

592.001.016 T210+ Test source for use with Solo 704 Adaptor Tube B (517.001.224) and Solo 100/101 Poles (517.001.230/226)
592.001.014 T210+Adaptor required for the T210+ to be used with S200 and S200 Plus Flame Detectors
592.001.010 T110 PP9 Battery and Charger Kit

Manual - Vol 01B-01-G5 "Detectors Fire Manual"

Flame Detector Test Equipment



Product Codes

592.001.012
T110 Test Source for use with Solo 704 adaptor tube B (517.001.224) and Solo 100/101 poles (517.001.230/226)

592.001.010
T110 PP9 Battery and Charger Kit



592.001.018
T110 Adaptor for series 600 and 800 flame detectors

Batteries, PSU and Chargers



Product Codes	Voltage (V)	Ah at 20h rate	Dimensions (mm)			Height including Terminals
			Length	Width	Height	
PS-1221	12	2.1	178	35	60	66
PS-1230	12	3.0	134	67	60	66
PS-1270	12	7.0	151	65	94	98
PS-1212	12	1.2	97	42	51	54
PS-12650	12	65.0	348	167	178	178
PS-12380	12	38.0	197	165	170	170
PS- 6100	6	10.0	151	51	94	98
PS-12170	12	17.0	181	76	167	167
PS-12260	12	26.0	166	176	112	125
PS-1242	12	4.5	90	70	101	105
PS-12120	12	12.0	151	98	94	100

Product Codes

- PS-1221 12 Volt 2.1 Ampere hour rechargeable sealed lead acid battery
- PS-1230 12 Volt 3.0 Ampere hour rechargeable sealed lead acid battery
- PS-1270 12 Volt 7.0 Ampere hour rechargeable sealed lead acid battery
- PS-1212 12 Volt 1.2 Ampere hour rechargeable sealed lead acid battery
- PS-12650 12 Volt 65.0 Ampere hour rechargeable sealed lead acid battery
- PS-12380 12 Volt 38.0 Ampere hour rechargeable sealed lead acid battery
- PS-6100 6 Volt 10.0 Ampere hour rechargeable sealed lead acid battery
- PS-12170 12 Volt 17.0 Ampere hour rechargeable sealed lead acid battery
- PS-12260 12 Volt 26.0 Ampere hour rechargeable sealed lead acid battery
- PS-1242 12 Volt 4.5 Ampere hour rechargeable sealed lead acid battery
- PS-12120 12 Volt 12.0 Ampere hour rechargeable sealed lead acid battery

Power Supply Unit

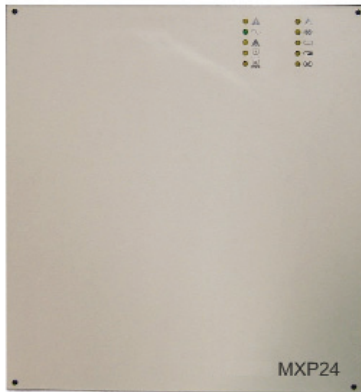

This PSU is approved by IMQ to EN 54-4:1997 + A1:2002 and EN60950-1:2001. The steel housing contains a 5 amp switch mode power supply and monitoring board and has space to accommodate 2 x 12V 17Ah sealed lead acid batteries. The 10 front panel LED's comprehensively indicate the status of the unit.

Features

- Robust metal housing
- Twin fused outputs
- Temperature compensated charging
- Deep discharge protection of batteries
- Fault relay output
- Size 383mm wide x 408mm high x 97mm deep
- Weight 4.3 Kg (excluding batteries)
- Operating temperature -5°C to +40°C
- Supply voltage 230VAC 50/60Hz
- Comprehensive LED status indication

Product Code

558.004.020 24V 5 Amp Power Supply Unit with housing for 17A/H Batteries

Door Release Equipment

Door Release Magnets



The door magnet range encompasses 2 metal and 2 ABS housed wall mounted and 1 floor mounted release magnet sets

Features

- Integral release button
- Attractive design
- Slimline ABS housed units
- Robust floor mounted unit



Door release magnet set, Wall Mount, Metal Housing, 24VDC

Product Code
3-59-0404-S001



Door release magnet set, Wall Mount, Metal Housing, 230VAC

Product Code
3-59-0404-S002



Door release magnet set, Wall Mount, ABS Housing, 24VDC

Product Code
3-87-0351



Door release magnet set, Wall Mount, ABS Housing, 230VAC

Product Code
3-87-0352

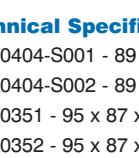

Door release magnet set, floor mount, ABS housing 24VDC

Product Code
3-84-0301

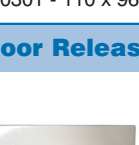

Floor mounting bracket for adapting wall mounted door magnets to floor mount

Product Code
2-34-035G-S001

Technical Specifications

3-59-0404-S001 - 89 x 89 x 70mm, 0.5Kg, 180N Holding Force, 1.15W Coil @ 24VDC

3-59-0404-S002 - 89 x 89 x 70mm, 0.5Kg, 180N Holding Force, 1.15W Coil @ 230VAC

3-87-0351 - 95 x 87 x 46mm, 0.36Kg, 200N Holding Force, 1.15W Coil @ 24VDC

3-87-0352 - 95 x 87 x 46mm, 0.36Kg, 200N Holding Force, 1.15W Coil @ 230VAC

3-84-0301 - 110 x 96 x 96mm, 0.7Kg, 200N Holding Force, 45mA Coil @ 24VDC

Door Release Power Supply



The Transformer Rectifier is a dual purpose, smoothed power supply providing either an energised or de-energised output upon activation. The output may be activated by utilising a set of volt free contacts from a fire or security panel, or by providing a 12/24Vdc trigger voltage from other apparatus.

The transformer rectifier units are normally used to control the operation of other 24Vdc equipment such as magnetic door retainers. The units are ideal for applications where the supply is to be energised from a remote source.

Technical Specification

Input Voltage: 230VAC 50Hz

Output Voltage: 22 - 30Vdc

Output Current: 4 Amps

Continuous

Temperature: -10C to + 40C

Relative Humidity: 95% RH

IP Rating: IP41 (excluding

rear face)

Material: 1.2mm white powder coated steel

Dimensions: 230mm (W) x 200mm (H) x 80mm (D)

Product Code

558.004.010
ELM 24V 4A Door Holder PSU

Door Release Button



Door Release Button supplied with surface mount backbox for manual release of door magnets or door release units.

Product Code

519.001.008
Door Release Button

Auxiliary Interface Relays

Boxed Relays



Product Codes

567.005.004

Relay 5010. Supplied with 1 PCB but can fit a maximum of 2 PCB's each containing up to 5 plug in relays. Order relay (**569.001.007**) separately.

568.001.002

Relay 5010 PCB (5 Relay)



Metal boxed heavy duty alarm relay with 25A mains rated DPCO contacts. Available with either a 240VAC 12mA or 24VDC 50mA rated coil. Suitable for heavy duty switching applications.

Product Codes

567.007.008

Alarm Relay 240Vac MK4

567.007.009

Alarm Relay 24Vdc MK4



RU1-24, this is a metal boxed auxiliary relay with 5 A Mains rated double pole contacts with a 24 VDC 25mA coil. This compact relay is suitable for interfacing a fire alarm controller to low current mains powered devices or contactors

Product Code

RU1-24

Relay Boxed 24Vdc Coil 5A contacts

Relays



Product Code

569.001.007

Cradle relay and retaining clip 2 C/O 26V nominal 700 ohm coil 5 amp (used with Relay 5000 and 5010).

Relay Output Board

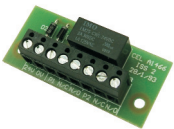

Technical Specifications

Gold clad contacts 2A @ 24VDC
DPCO

Coil resistance 2900 ohms

Operating current 8mA @ 24VDC

Operating Voltage 17.5 - 30 VDC

Terminals suitable for 2.5mm² cable

26mm x 60mm x 18mm

Polarised and suppressed

Product Code

508.023.036

A1466 Relay Output Board

Fire Notice Frames

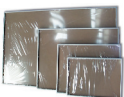

These frames are used mainly for Fire Alarm Zone Charts and are available to fit A4 to A1 size drawings. These come supplied with fitting hooks.

Product Codes

525.001.005

A4 Dimensions: 212mm x 297mm

525.001.006

A3 Dimensions: 280mm x 356mm

525.001.008

A2 Dimensions: 483mm x 367mm

525.001.007

A1 Dimensions: 483mm x 737mm

Fire Resistant Cable

DÄTWYLER Lifeline cable is suitable for fire alarms and emergency lighting where BS6387 and BS7629 standards are acceptable and meets the installation and performance requirements of:

- BS5839 Pt.1 for use in fire alarms
- BS5266 for use with emergency lighting
- IEC331 fire resistance

Lifeline is LPCB approved to BS6387 CAT CWZ and BASEC approved to BS7629.

Lifeline is low smoke, zero halogen, has an integral aluminium backed mylar tape screen with tinned drain wire and requires no special terminations, tools or ferrules for installation.

Technical Specification

Construction

Conductor:	Bare copper, solid or stranded to BS 6360
Insulation:	Special double layer insulation according to BS 7655, E15
Inner Covering:	High temperature resistant glass fibre tape
Screening:	Al-Laminated tape with tinned copper drain wire, solid to BS 6360
Outer Sheath:	Flame retardant polyolefin compound according to BS 7655, LTS3

Technical Properties

Rated Voltage:	300/500V
Test Voltage:	2000V, 50Hz core/core 2000V, 50Hz core/screen
Operating Temp:	-15°C to +90°C
Core Colours:	2 cores + earth: red, black 4 cores + earth: red,yellow,blue,black
Sheath Colour:	Red or white

General Properties

Zero Halogen, no corrosive gases - IEC 60754-2, BS 6425 part 1
 Reduced fire propagation - IEC 60332-3, BS 4066 part 3
 Minimum smoke emission - IEC 61034, BS 7622
 Insulation integrity - IEC 60331 (FE180), BS 6387 (cat. CWZ)

Approvals

BASEC

Full details of Lifeline cable can be found in the DÄTWYLER Lifeline datasheets on the Tyco Fire Protection Products website (www.tycoemea.com).

DÄTWYLER offer a wide range of cable and safety cabling systems including complete safety cable systems to DIN4102 part 12.

The following DÄTWYLER Lifeline cables are held in stock at Tyco Fire Protection Products Letchworth warehouse, together with suitable P clips and glands. Cables are priced per metre but must be ordered in units of 100 metre. P clips and glands are priced each but must be ordered in packs.

Product Codes

Product Codes	DÄTWYLER Lifeline cable			
	No. Cores	Core Size	Colour	Clips
599.048.020	2 + earth	1 mm	Red	P34 R
599.048.022	2 + earth	1.5 mm	Red	P34 R
599.048.023	2 + earth	1.5 mm	White	P34 W
599.048.024	2 + earth	2.5 mm	Red	P37 R
599.048.032	4 + earth	1 mm	Red	P37 R
599.048.034	4 + earth	1.5 mm	Red	P40 R
599.048.035	4 + earth	1.5 mm	White	P40 W
599.048.036	4 + earth	2.5 mm	Red	P43 R

Product Codes	DÄTWYLER Lifeline Fire Resistant P Clips & Glands		
	Qty. per pack	Reference	Colour
599.048.001	50	P34	Red
599.048.002	50	P34	White
599.048.003	50	P37	Red
599.048.005	50	P40	Red
599.048.009	10	NG1	Red
599.048.010	10	NG1	White

No. of Cores x Cross Section (n x mm ²)	Copper Content (Kg/Km)	Total Weight (Kg/Km)	Outer Diameter (approx. mm)	Calorific Potential (KWh/m)
2 x 1.0	19	75	7.4	0.16
2 x 1.5	29	97	8.2	0.18
2 x 2.5	48	141	9.6	0.24
4 x 1.0	39	114	8.6	0.23
4 x 2.5	96	223	11.3	0.37

This page is left intentionally blank.

Aspirating Smoke Detection

Vesda aspirating smoke detection provides a high sensitivity method for detection of fires at a very early stage - it is ideal for computer rooms and other high risk and high value areas. The range of products range from the Laserfocus for small risks up to the LaserPlus range of networkable 4 pipe panels.



Features

- Laser Based Absolute Smoke Detection
- Very Early Warning of a Potential Fire Incident
- Wide Sensitivity Range (0.025%-20% obs/m) (0.008 - 6.4% obs/ft)
- Detection Capabilities for smaller critical areas up to 500m
- Dual Stage Dust Filtration
- Programmable Alarm Thresholds
- Reliable Air Flow Monitoring
- Easy User Interaction
- AutoLearn Smoke & Flow
- Pre-engineered Pipe Designs

LaserFOCUS Aspirating Smoke Detection

Incorporating detection methodology derived from its VESDA predecessors - the VESDA LaserFOCUS multiple point air sampling technology works by utilising a highly effective aspirator that continually draws air into its laser detection chamber via a pipe network.

Accurate assessment of the air sample using calibrated detection and long detector life expectancy, are assured with a patented dual stage filtration process that both eliminates background 'noise' and preserves the optical integrity of the laser technology with its clean air bleed. The result of which is an unchallenged detection process able to provide reliable and consistent very early warning smoke detection performance across a diverse range of applications.

Technical Specification

Supply Voltage:	18 to 30 Vdc
Current Consumption:	220mA quiescent 295 mA alarm
Dimensions:	255H x 185W x 90Dmm
Weight:	2 kg
IP Rating:	IP30
Operating Temp:	0°C to + 40°C
Sampled Air:	0°C to + 40°C
Humidity:	5% to 95% (non condensing)

Product Codes

516.018.020	VLF-250 Vesda Laserfocus (with English overlay)
516.018.022	VIC-010 LaserFocus VesdaNetwork Card
516.018.023	VLF-500 Vesda Laserfocus (with English overlay)



Features

- Reduced size
- Absolute smoke detection
- Wide sensitivity range
- Single pipe inlet
- Simple display
- Referencing
- VESDAnet communication (VN)
- Dual stage dust filter
- Three alarm levels
- Configurable relays
- Air flow monitoring
- Optional remote display and relay capability
- Simple mounting design
- AutoLearn™
- Marine Approved Version

LaserCOMPACT™ and MX LaserCOMPACT™

The LaserCOMPACT and VLC800 MX Laser compact detector has been specifically designed to provide all the benefits of aspirating smoke detection, including very early warning, in single small areas and where space is a premium.

This has been achieved through the combination of approved LaserPLUS detection technology, dual stage filtration technology and a modified aspirator design incorporated in a smaller enclosure with simplified display.

The LaserCOMPACT is available in two versions, one that interfaces via relays only (RO) or across either the relays or VESDAnet™ (VN).

The VLC 800MX Laser Compact is available with an in-built MX interface to enable it to communicate directly with the MX loop.

Technical Specification

Supply Voltage:	18 to 30Vdc
Current Consumption:	225mA quiescent, 245mA in alarm
Dimensions:	225H x 225W x 85Dmm
Weight:	1.9Kg
Operating Temp:	-10°C to+ 39°C
Sampled Air:	-20°C to +60°C

Product Codes

516.018.011	VLC-505-VN VESDA net Version (VN)
516.018.010	VLC-500-RO Relays Only Version (RO)
516.018.012	VLC800 MX Addressable Vesda Laser compact (Compatible with MX Consys versions 2.1 and above)
516.018.030	VLC-500-RO Relays Only Version (RO) Marine
516.018.031	VLC-500-VN Vesdanet Version (VN) Marine
516.018.032	VRT-J00 Remote Display c/w 7 relays Marine



Features

- Wide sensitivity range
- Laser-based light source
- 4 Configurable alarm levels
- Purpose built Aspirator
- 4 In-line Inlet pipes
- Flow sensor for each inlet pipe
- Wide range DC power
- Low-cost maintenance
- Dual stage filter
- Easy access to filter cartridge
- 7 Software configurable relays
- Recessed mounting
- Multiple exhausts

LaserPLUS Standard Modular Range

The detector assembly contains the laser detection chamber, high efficiency aspirator, monitored filter cartridge, control electronics and relay interface. The detector assembly can be used as a “distributed” system, with the display, programmer and VESDAnet socket modules mounted in a remote location.

Alternatively, the detector assembly can be configured as a “self-contained” system by replacing the detector’s blank panels with the display and/or programming modules.



516.018.001
VLP-012 LaserPLUS Detector, programmer and display

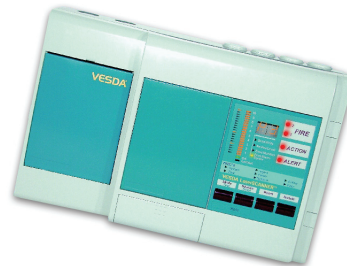

516.018.002
VLP-002 LaserPLUS Detector and display

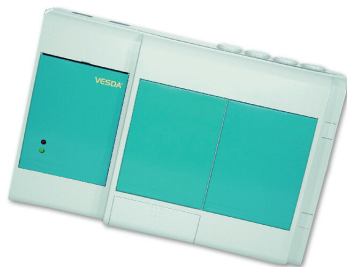

516.018.013
VLP-400 LaserPLUS Detector with fire OK LED

Technical Specification

Supply Voltage:	18 to 30Vdc
Current Consumption:	(No display or programmer) 240mA quiescent plus 50mA alarm (24Vdc at 3000 rpm)
Dimensions:	225H x 350W x 125D mm
Weight:	4.0Kg (including display and programmer modules)
Operating Temp:	0°C to + 39°C
Humidity:	0-95% RH, non condensing

Product Codes

516.018.001	VLP-012 LaserPLUS Detector, programmer and display
516.018.002	VLP-002 LaserPLUS Detector and display
516.018.013	VLP-400 LaserPLUS Detector with fire OK LED

Features

- Individual pipe annunciation
- Adaptive scan threshold
- Wide sensitivity range (0.005 to 20% obs/m)
- Laser based light source
- Configurable alarm levels
- Purpose built Aspirator
- 4 In-Line inlet pipes
- Flow sensor for each pipe inlet
- Low-cost maintenance
- Dual stage filter
- Easy access to filter cartridge
- Recessed mounting



LaserPLUS Scanners

VESDA LaserPLUS is also available in a Scanner configuration, which allows the system to distinguish and identify the pipe carrying smoke, while sampling multiple sectors.

The VESDA LaserPLUS will continue to sample from all sectors to monitor the fire growth and maintain full protection.

VLS-214/314 FD7/FD12 Scanner



Product Codes

516.018.004
VLS-214 FD7 Scanner, programmer and display with 7 relays.

516.018.007

VLS-314 FD12 Scanner, programmer and display with 12 relays

VLS-600/700 FD7/FD12 Scanner



Product Codes

516.018.016
VLS-600 FD7 Scanner with Fire OK LED
516.018.019
VLS-700 FD12 Scanner with Fire OK LED

VLS-204/304 FD7/FD12 Scanner



Product Codes

516.018.005
VLS-204 FD7 Scanner and display with 7 relays.

516.018.008

VLS-304 FD12 Scanner and display with 12 relays

Technical Specification

Supply Voltage: 18 to 30Vdc
 Current consumption: (No display or programmer) 240mA quiescent plus 70mA alarm (24Vdc at 3000 rpm)
 Dimensions: 225H x 350W x 125D mm
 Weight: 4.0Kg including display and programmer modules
 Operating Temp: 0°C to + 39°C
 Humidity: 10-95% RH, non condensing
 Relay Outputs: 7 or 12

Product Codes

516.018.004 VLS-214 FD7 Scanner, programmer and display with 7 relays.
 516.018.007 VLS-314 FD12 Scanner, programmer and display with 12 relays
 516.018.005 VLS-204 FD7 Scanner and display with 7 relays.
 516.018.008 VLS-304 FD12 Scanner and display with 12 relays
 516.018.016 VLS-600 FD7 Scanner with Fire OK LED
 516.018.019 VLS-700 FD12 Scanner with Fire OK LED

Datasheet - Product Code **PSF105U** "VESDA LaserPLUS"



Features

- Four alarm levels (Alert/Action, Fire 1 & Fire 2)
- 20 segment vertical bar graph
- Alarm threshold indicators (Alert, Action & Fire 1)
- Audio and visual indication
- Alarm indicators
- Informative fault indicators
- Multi-mode numeric display (defaults to smoke obscuration)
- Acknowledged push-button presses
- Multiple language supported
- Addressable to any detector

Remote Displays and Modules

A display module monitors the VESDA LaserPLUS detector. It reports a visual representation of smoke levels, and all alarm and fault conditions. The internal sounder warns personnel in the local area that an alarm threshold has been reached, or a fault has occurred.

It has a 20 segment vertical bar graph, a 2-digit numerical display, an audible sounder and clear alarm and fault indicators. It also has 4 push buttons to control the detector and the mode of the display.

Displays can be located at a convenient location - either within the detector module, or remotely on the VESDAnet. For monitoring convenience, multiple displays can be associated with a single detector.

VRT-400,700 & 800



Product Codes

516.018.104
VRT-400 Remote scanner display including 7 relays

516.018.107
VRT-700 Remote scanner display - no relays
516.018.108
VRT-800 Remote scanner display with 12 relays

VRT-200,600,J00 and K00 displays



Product Codes

516.018.102
VRT-200 Remote display including 7 relays

516.018.106
VRT-600 Remote detector display- no relays
516.018.119
VRT-J00 Compact Display c/w 7 relays

516.018.120
VRT-K00 Compact Display no relays

VRT-300 Remote VESDAnet socket



Product Code

516.018.103
VRT-300 Remote VESDAnet socket

VRT-100 Remote programmer



Product Code

516.018.101
VRT-100 Remote programmer

Technical Specification

Supply Voltage:	18-30Vdc (when used in detector unit, Remote unit or 19" rack)
Current Consumption:	60mA quiescent plus 20mA alarm @24Vdc - (module only)/90mA quiescent plus 20mA alarm @24Vdc (in remote mounting box)
Dimensions:	150H x 140W x 90D mm
Operating Temp:	0°C to +39°C
Humidity:	10-95% RH, non condensing

Chapter 7 - VESDA

LaserPLUS Standard 19 Inch Sub-Rack Remote Display Assemblies



The 19" sub-rack is available as a mounting option, with 4 mounting slots for display or programming modules.

Technical Specification

Dimensions: 128H x 482W x 120D mm

Product Codes

[516.018.201](#)
VSR-2000 19" Sub-rack with 1 detector display and 3 blanks
[516.018.203](#)
VSR-2210 19" Sub-rack, 2 detector displays, programmer and 1 blank

[516.018.204](#)
VSR-2221 19" Sub-rack with 3 detector displays and programmer
[516.018.206](#)
VSR-2222 19" Sub-rack with 4 detector displays

LaserPLUS Components for Ordering Custom Built Remote Display Sub-racks



Sub-rack configurations other than those available as standard can be supplied as custom built units. The sub-rack and cost of assembly are included in the VSR-CUSTOM.

The configuration of the custom built unit must be specified at time of ordering (e.g. 2 x VSU-0 and 2 x VSU-2 configured as VSR-0022)

Note: The order of the numbers (e.g. 0022) indicates the order in which the sub-units will be mounted in the sub-rack housing when looking from the front of the unit - from left to right.

Product Codes

[516.018.260](#)
VSU-0 Blank Sub-unit
[516.018.261](#)
VSU-1 Programmer sub-unit
[516.018.262](#)
VSU-2 Detector display sub-unit plus 7 relays
[516.018.264](#)
VSU-4 Scanner display sub-unit plus 7 relays
[516.018.265](#)
VSU-5 Blank sub-unit with 7 relays
[516.018.214](#)
VSU-E Blank scanner sub-unit with 7 relays

[516.018.268](#)
VSU-8 Scanner display sub-unit with 12 relays
[516.018.269](#)
VSU-9 Blank display sub-unit with 12 relays
[516.018.219](#)
VSU-J Compact display sub-unit plus 7 relays
[516.018.210](#)
VSR-CUSTOM Custom sub-rack housing includes cost of custom building 4 VSU sub-rack units.

LaserPLUS Standard 19 Inch Rack Remote Display Assemblies



Standard rack enclosure to fit 2 sub-rack assemblies.

Technical Specification

Dimensions:
020-050 300H x 400W x 140D mm

Product Code

[516.018.303](#)
020-050 IP65 Enclosure

LaserPLUS Ancillaries & Power Supply Unit



A variety of other ancillaries are available. Configuration software is available from the Xtralis website www.vision-fs.com.

Product Codes

[516.018.402](#)
VHX-0200 PC link HLI plus leads (MK2)
[516.018.407](#)
VESDA VPS-220 2A 24VDC PSU
[516.018.410](#)
VESDA VPS-250-E 2A 24VDC PSU
[516.018.401](#)
VHH-100 Hand held programmer plus leads

LaserPLUS Spares



The following common VESDA LaserPLUS spares are kept in stock by Tyco Fire Protection Products. Other spares can be supplied if required.

Product Codes

[516.018.502](#)
VSP-004 Scanner display (spare)
[516.018.505](#)
VSP-019 Filter cover door (spare)

[516.018.506](#)
VSP-006 Spare detector chassis and manifold
[516.018.508](#)
VSP-008 Spare remote termination card 7 relays
[516.018.509](#)
VSP-009 Spare scanner chassis and manifold

[516.018.514](#)
VSP-014 Spare header termination card 7 relays
[516.018.515](#)
VSP-015 Spare aspirator fan
[516.018.504](#)
VSP-005 Filter cartridge (spare)



Features

- Powerful fan
- Upto two x 50m pipe runs
- Pipes can be individually monitored for air flow with LED bar graph
- MX Loop and 24 VDC connections
- Fault monitored via the MX Loop
- IP65 enclosure
- Field serviceable air filters
- Uses standard 25mm Vesda pipe & fittings

ICAM IAS800 Air Sampling Smoke Detection Systems

The ICAM IAS800 Air Sampling Smoke Detection System provides a flexible solution to meet the unique needs of numerous applications including industrial spaces such as cable tunnels, tamper proof and unobtrusive requirements for special accommodation, or can simply be used to replace spot (point) detectors in office environments.

The IAS800 system actively draws air from the protected area through sampling holes in a pipe network. Sampled air is then filtered before being analyzed by upto two MX Technology detectors.

The IAS800 system is available in three configurations:-

IAS800 twin inlet pipe configuration which can be fitted with two detectors for monitoring one or two pipe runs.

IAS801 single inlet pipe configuration which can be fitted with one detector.

IAS802 twin inlet pipe configuration which can be fitted with two detectors for monitoring one or two separate pipe runs with independant fault outputs.

The system utilises a high performance aspirator and software configurable flow monitoring circuitry. The air flow level is displayed on a ten element bar graph that can be adjusted for high and low flow thresholds, and flow failure is reported as a device fault via upto two MX Technology MIM800 addressable modules.

Applications:

Ideal for areas where access is restricted, harsh environments and areas where a point detector would be damaged. Such as:-

- Lift Shafts
- Floor / Ceiling Voids
- Cabinet Protection
- Conveyor Tunnels
- Hose Down Areas
- Stables
- Prison Cells
- Areas with Low Ceilings

Technical Specification

Supply Voltage	18 to 30Vdc
Current Consumption	300mA
Dimensions	259w x 184h x 166dmm
Weight	2.77 Kg
Operating Temp	-10 to +55°C (with detectors)
Humidity	10 to 90% RH NonCondensing
Sampling Pipes	25mm dia, 50m per inlet

Product Codes

516.016.301	ICAM IAS800 Aspirated Smoke Dual Detector common fault monitor
516.016.303	ICAM Course Filter (PK10)
516.016.304	ICAM IAS801 Aspirated Smoke Single Detector common fault monitor
516.016.305	ICAM IAS802 Aspirated Smoke Dual Detector dual fault monitor
516.016.306	ICAM In-Line Filter Housing

Note: Detectors to be ordered separately.

Vesda Pipe, Fittings and Test Equipment

VESDA Aspirating Pipe & Fittings are a metric standard of 25mm external diameter with suitable adaptors available for imperial to metric conversions. (British Standard approved pipes BS5391 Part 1 1976 and BS5391 Part 1 1976 for fittings). The British manufactured pipe is produced in red ABS under stringent quality control approved to BS EN ISO9001, which covers all aspects of product design, manufacture and inspection.



Features

- Toughness and durability
- Chemical resistance
- Easy to joint
- Low Friction
- Wide temperature range
- Lightweight
- Red colour for easy identification

Aspirating Pipe & Fittings

Pipe 25mm diameter



VESDA aspirating pipe, printed along its length on opposite side at 450mm intervals. 3 m length pipe. Order in multiples of 10.

Product Code

516.018.901
Pipe 25mm diameter

Socket 25mm



Straight socket for 25mm pipe. Order in multiples of 10.

Product Code

516.018.902
Socket 25mm

Socket union 25mm



Socket union to facilitate servicing of pipework. Order in multiples of 1.

Product Code

516.018.903
Socket union 25mm

Socket Adaptor 25mm to 3/4"



Socket adaptor, imperial to metric, to extend existing systems. Order in multiples of 5.

Product Code

516.018.909
Socket Adaptor 25mm to 3/4"

Bend 25mm



90 degree Long Radius bend. Order in multiples of 5.

Product Code

516.018.904
Long Radius bend 90°

Chapter 7 - VESDA

Elbow 25mm



45 deg elbow.
Order in multiples of 5.

Product Code
516.018.905
Elbow 25mm

End Cap 25mm



End cap 25mm.
Order in multiples of 5.

Product Code
516.018.906
End cap 25mm

Equal Tee 25mm



Equal Tee 25mm.
Order in multiples of 5.

Product Code
516.018.907
Equal Tee 25mm

In-Line Filter



In-Line Filter, suitable for all Vesda
Aspirating Smoke Detectors.

Product Code
516.018.925
In-Line Filter (red) for use with Vesda
ASD systems

Filter Elements

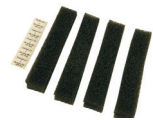

Dual density replaceable filter
elements for use with In-Line Filter.

Product Code
516.018.926
Replacement Filter Elements
(pack of 4)

Pipe Clip 25mm



Pipe Clip 25mm.
Order in multiples of 10.

Product Code
516.018.908
Pipe Clip 25mm

Solvent Cement (0.25 Litre Tin)



Solvent cement.

Product Code
516.018.910
Solvent cement

Capillary Tube Conical Sample Point Assembly



Capillary Tube Conical Sample Point
Assembly. 25mm socket adaptor +
2m capillary tube (tube colour - red).

Product Code
516.018.911
Capillary Tube Conical Sample Point
Assembly

Capillary Tube Flush Sample Point Assembly



Capillary Tube Flush Sample Point
Assembly. 25mm socket adaptor +
2m capillary tube (tube colour - red).

Product Code
516.018.912
Capillary Tube Flush Sample Point
Assembly

Capillary Tube 10 mm



Capillary Tube 10 mm.
10mm o/d x 30m length
(tube colour - red).

Product Code
516.018.915
Capillary Tube 10 mm

Chapter 7 - VESDA

Pipe Cutters



Pipe Cutter.

Product Code
516.018.918
Pipe Cutter

Pipe Ties



Pipe Ties (Red).
Order in multiples of 100.

Product Code
516.018.920
Pipe Ties (Red)

Sampling Point Label (1 reel)



Sampling point label. Order in multiples of 100.

Product Code
517.017.005
Sampling point label

Pipe Label (1reel)



Pipe Label. Order in multiples of 100.

Product Code
517.017.006
Pipe Label

Pipework designs for Vesda Systems must be verified by the use of the "Aspire" pipework Design Software Tool. Available for download from the Xtralis Website at www.vision-fs.com.

Test Equipment

Wire Burn Test Box



Wire burn test box designed to heat up a measured length of special wire to produce smoke, used to test the transport time and performance of Vesda aspirating smoke detectors.

- Built in timer
- Insulated terminals
- Selectable input voltage
- Illuminated power on indicator
- Robust enclosure
- Supplied with UK power lead

Technical Specification

Input Voltage: 110-120 or 220-240VAC
Output Voltage: 6.3VAC @ 20A
IP rating: IP30
Timer: 1 to 3 mins
Dimensions: 170w x 120d x 135h (mm)
Weight: 2.75Kg

Product Code

516.018.921
Wire Burn Test Box

Smoke Test Wire



Smoke test wire for use with the wire burn test box.

Technical Specification

Size - 10/0.1mm, 0.078 mm² CSA
Length - 100m
Weight - 0.25Kg

Product Code

516.018.923
Smoke Test Wire

A – VESDA Aspirating Smoke Detector
 B – Detection pipe work
 C – VESDA ECO Gas Detector

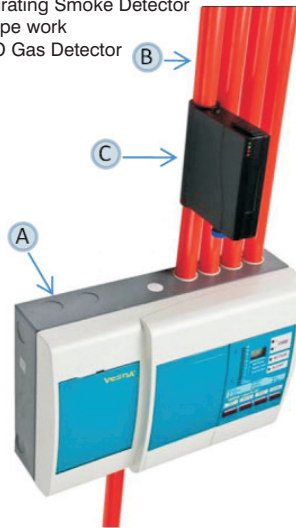

Features

- Single gas or dual gas versions available
- Greater coverage than point gas detection
- Highly cost effective solution
- Can use the same pipe work to detect smoke and gas hazards
- Easily retrofitted to existing VESDA ASD installations
- Relay, 4-20mA and RS485 Modbus interfaces provided as standard
- High level interface to MZX via the DDM800 module
- On-board data logging

VESDA ECO Gas Detection

Gas Detection and Aspirating Smoke Detection Plus Environmental Monitoring

The VESDA ECO is a gas detector module that is inserted into the pipework of a VESDA aspirating smoke detector. Different VESDA ECO models detect different gasses.

Applications

VESDA ECO by Xtralis provides protection from both fire and gas threats in powerful yet cost effective configurations to provide point, zone or total area coverage in a variety of applications including:

- Battery charging rooms
- Underground utility tunnels
- Boiler rooms
- Warehouses
- Manufacturing facilities
- Parking garages
- Transportation centres

Areas requiring gas detection often also require a fire / smoke detection system. Xtralis VESDA ECO combines gas detection capability with VESDA aspirating smoke detection (ASD) at minimal additional cost. This combined solution can be significantly less expensive than a number of conventional standalone fixed point gas detectors and a separate fire detection system. Routine maintenance costs are also reduced as a single service contract can cover both systems.

It is common practice to provide constant ventilation of plant and process areas to reduce the risk of a gas hazard. The energy costs associated with this solution can be considerable. As an alternative, gas detection can be used to activate or boost ventilation only when required and consequently reduce HVAC operating costs. VESDA ECO provides an economical method of providing gas detection over a wide area for this application.

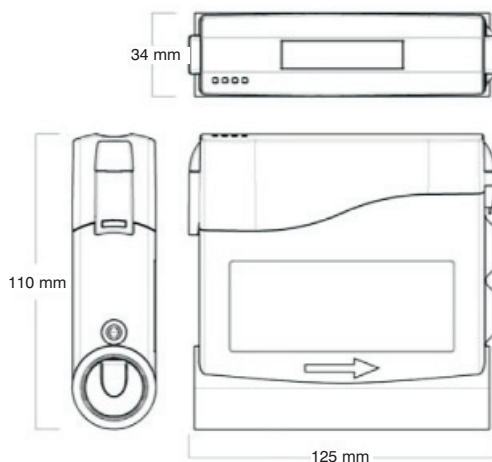

Chapter 7 - VESDA

VESDA ECO Gas Detection

Product Codes

VESDA ECO Detectors

ECO-D-B-11	ECO Hydrogen H ₂ Gas Detector H ₂ 0-100% LEL
ECO-D-B-12	ECO Methane CH ₄ Gas Detector 0-100% LEL
ECO-D-B-13	ECO Propane C ₃ H ₈ Gas Detector 0-100% LEL
ECO-D-B-31	ECO Oxygen O ₂ Gas Detector 0-25% Vol
ECO-D-B-41	ECO Carbon Monoxide CO Gas Detector 0-500 PPM
ECO-D-B-42	ECO Ammonia NH ₃ Gas Detector 0-100 PPM
ECO-D-B-43	ECO Hydrogen Sulphide H ₂ S Gas Detector 0-100 PPM
ECO-D-B-44	ECO Sulphur Dioxide SO ₂ Gas Detector 0-10 PPM
ECO-D-B-45	ECO Nitrogen Dioxide NO ₂ Gas Detector 0-10 PPM
ECO-D-B-41-45	ECO Dual Gas Detector Carbon Monoxide CO 0-500 PPM + Nitrogen Dioxide NO ₂ 0-10 PPM

VESDA ECO Replacement Sensor Cartridges

ECO-SC-11	ECO Spare Cartridge Hydrogen H ₂ 0-100% LEL
ECO-SC-12	ECO Spare Cartridge Methane CH ₄ 0-100% LEL
ECO-SC-13	ECO Spare Cartridge Propane CH ₃ 0-100% LEL
ECO-SC-31	ECO Spare Cartridge Oxygen O ₂ 0-25% Vol
ECO-SC-41	ECO Spare Cartridge Carbon Monoxide CO 0-500 PPM
ECO-SC-42	ECO Spare Cartridge Ammonia NH ₃ 0-100 PPM
ECO-SC-43	ECO Spare Cartridge Hydrogen Sulphide H ₂ S 0-100 PPM
ECO-SC-44	ECO Spare Cartridge Sulphur Dioxide SO ₂ 0-10 PPM
ECO-SC-45	ECO Spare Cartridge Nitrogen Dioxide NO ₂ 0-10 PPM
ECO-SC-41-45	ECO Spare Cartridge Dual Carbon Monoxide CO 0-500 PPM + Nitrogen Dioxide NO ₂ 0-10 PPM

Technical Specification

Mechanical

Weight:	250 g
Dimensions:	110x125x34mm
Pipe external diameter:	25 mm
Terminal size:	1.5mm ²
Cable Access:	2xM16 bulkhead grommets

Environmental

Ingress protection:	IP65 and NEMA 4
Operating temp:	-20 to 55°C
Sampled air temp:	-20 to 55°C
Humidity:	10-95% RH, non-condensing

Electrical

Voltage:	18-30 VDC
Current quiescent:	Typically 60 mA @ 24 V DC
Current alarm:	85 mA
Power consumption:	3.2 W
Outputs:	RS 485 Modbus RTU Four programmable relays 30 VDC 1A 4-20 mA output
Onboard Memory Card:	Micro SD card 2 GB



Features

- Maximum detection range of 150 metres for the OSI-10
- Status LEDs for Fire, Fault and Power
- High false alarm immunity
- Dust and intrusive solid object rejection
- Easy alignment with large adjustment and viewing angles
- No need for precise alignment
- Tolerant of alignment drift
- Automatic commissioning in under ten minutes
- Simple DIP switch configuration
- Dual wavelength LED-based smoke detection
- Simple and easy maintenance requirements
- Conventional alarm interface for straightforward fire system integration
- Three selectable alarm thresholds

OSID Smoke Detection

Open-area Smoke Imaging Detection (OSID) by Xtralis is a new innovation in projected beam smoke detection technology. By using advanced dual wavelength projected beams and optical imaging technology, OSID provides a low-cost, reliable and easy to install solution that overcomes typical beam detection issues such as false alarm incidents and alignment difficulties.

Unique Detection Technology

The OSID system measures the level of smoke entering beams of light projected over an area of protection. A single OSID Imager can detect up to seven Emitters to provide a wide coverage area.

Simple Installation and Maintenance

The OSID system consists of up to seven Emitters, for the 45° and 90° Imager units, located along the perimeter of the protected area, and an Imager mounted opposite. Each component can be mounted directly to the surface or can be secured with the supplied mounting brackets. Battery powered Emitters with up to five years battery life are also available to reduce installation time and cost.

Technical Specification

Supply Voltage 20 to 30 VDC (24 VDC nominal)

Imager Current Consumption
 Nominal (at 24 VDC):
 4 mA (1 Emitter)
 7 mA (7 Emitters)
 Peak (at 24 VDC) during training mode: 27 mA

Emitter Current Consumption
 Wired Version (at 24 VDC): 350 µA

Battery Version Built-in 5 Year Battery

Adjustment Angle
 ±60° (horizontal)
 ±15° (vertical)

Maximum Misalignment Angle
 ± 2°

Dimensions (WHD)

Emitter / Imager 198 mm x 130 mm x 96 mm

Operating Conditions*

Temperature -10 °C to 55 °C *

Humidity 10 to 95% RH (non-condensing)

IP Rating

IP 44 for Electronics

IP 66 for Optics Enclosure

Status LEDs

Fire Alarm (Red)

Trouble / Power (Bi-color Yellow / Green)

Product Codes

OSI-10	Imager 7° coverage
OSI-45	Imager 38° coverage
OSI-90	Imager 80° coverage
OSE-SP	Emitter Standard Power
OSE-SPW	Emitter Standard Power, Wired
OSE-HPW	Emitter High Power, Wired
OSID-INST	OSID Installation Kit
VKT-301	OSID Demo Kit (2 x OSE-SPW + 1 x OSI-90 + 1 x OSID-INST + Stand and Carry Case)

This page is left intentionally blank.

Fire Phones and Disable Refuge



Features

- Meets the requirements of BS5839 Part 9.
- Ideal for all disabled refuge and fire telephone applications.
- Compact 4 or 8 line (expandable to 12 or 16) wall mounted central control unit which saves space in crowded control rooms.
- Type B 'disabled refuge' outstations offer true duplex handsfree speech. Available in stainless steel or green steel flush, surface and weatherproof versions.
- Type A 'fire telephone' outstations come in locking or non locking red steel cabinets and offer true duplex speech. Flush and surface versions are available.
- Unique 'auto learn' facility allows fast network set up.
- All extensions can be named with user defined text of up to 15 characters.
- Fully monitored hardware and software.
- System operates at 24Vdc.
- In the event of mains failure, operation can be maintained for 24 hours (standby) and 3 hours (in use) using 2 x 12V 7Ah SLA batteries.

Cel TEL Disabled Refuge and Fire Telephone System

CelTEL comprises of a low cost, all-in-one, wall mounting controller which can handle 4 or 8 lines (expandable to 12 or 16 lines via an 8 line slave unit). Typically it would be located in a building's control room (or in smaller applications at a fire services access point). It allows the management and/or the emergency services to communicate via a telephone style handset with the system's outstations.

For larger systems up to 4 controllers can be interlinked using a network communication card allowing systems of up to 64 lines to be easily implemented.

Cel TEL 1-64 Line Controllers

CelTEL 4 Way Master EVC Panel with Handset and Display

- Allows operators to communicate with up to 4 x Type A or B outstations.
- Supplied with a backlit LCD and handset.
- Requires 2 x 12v 7Ah SLA batteries.
- Can be semi flush mounted using the bezel.
- Optional tamper resistant cabinet.

CelTEL 8 Way Master EVC Panel with Handset and Display

- Allows operators to communicate with up to 8 x Type A or B outstations.
- Same features as 4 Way Master EVC Panel.

CelTEL Slave EVC Panel with 8 Additional Lines

- Can be connected to a Master EVC Panel to increase its line capacity upto 16.
- Does not require a separate mains supply or batteries since it takes power from the Master EVC Panel.
- Can be semi flush mounted using the bezel.

CelTEL EVC Network Communication Card

- Allows the interconnection of up to 4 x Master Controllers over a 1km network.
- One card required per networked Master Controller.
- Allows systems of up to 64 lines (4 x Master Panels each with a Slave Panel) to be easily setup.
- Any Master EVC Panel can take control of the system by the input of a special code.
- For networked systems that do not require multiple control points, Master Controllers without Handsets are available.

Anti Tamper Enclosure for the CelTEL Master EVC Panel

- A tough tamper resistant cabinet for housing the Master EVC Controller in areas that are accessible to the general public.
- Helps ensure the Controller remains operational at all times by reducing the risk of vandalism.
- Flush and semi flush stainless steel and weather resistant options also available.

Type B Disabled Refuge Outstations



Features

- Allows anyone in the Refuge Area to communicate with building control at the touch of a button and vice versa.
- High quality brushed stainless steel or green finish.
- Includes connections for an optional audio frequency induction loop system.
- Easily interfaced to strobes, CCTV activation relays and/or disabled persons toilet alarm systems.

Weatherproof IP65 Enclosure for the Type B Surface Mounting Disabled Refuge Outstation

Features

- An IP65 rated weather resistant enclosure designed for use with the Surface Type B Outstation.
- Allows an IP65 rated Type B Outstation to be created for use in external areas.
- Supplied with a locking keyswitch mechanism that can be changed to a semi secure handle.
- Optional bezel available.

Type A Fire Telephone Outstations



Features

- Designed for use in fire telephone and stadium marshalling applications.
- Allows fire marshals and stewards to communicate via a telephone handset.
- Typically located at entrances and fire fighting lobbies.
- Supplied in a lockable red steel wall mounted cabinet that can be semi flushed with an optional bezel.

Disabled Persons Toilet Alarm



Features

- Includes everything required for a BS8300 compliant emergency assistance alarm.
- Can be interfaced with the CeITEL Disabled Refuge System by wiring directly to a spare line.

CeITEL EVC Typical System Layout

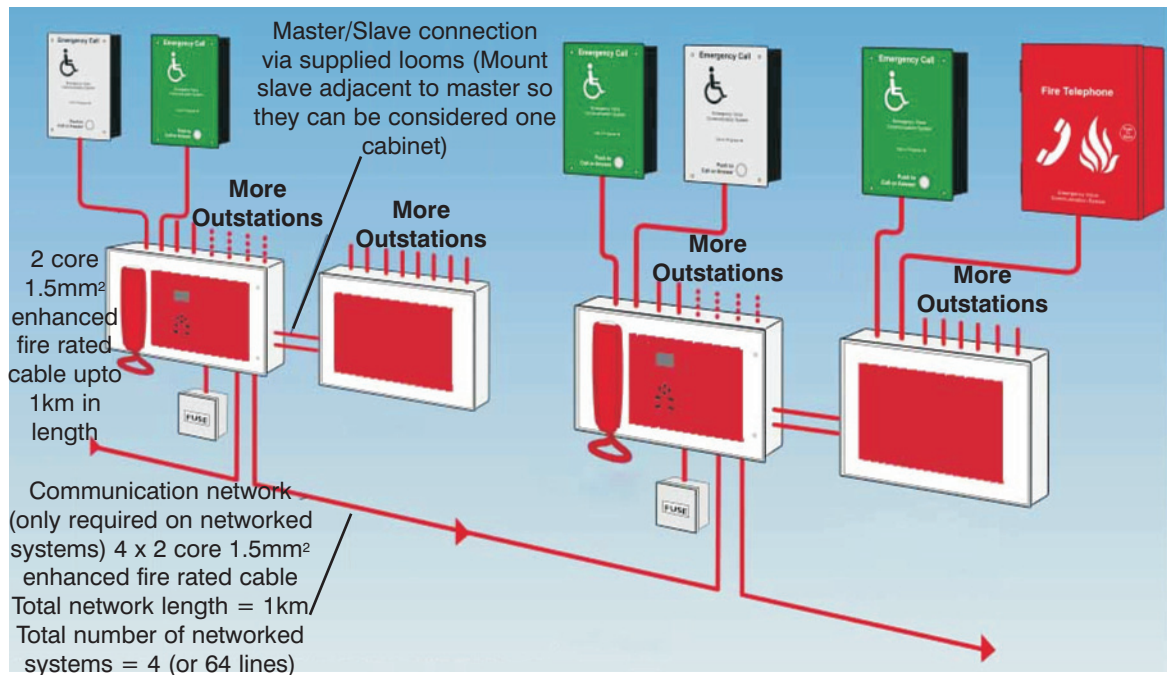

Chapter 8 - Fire Phones and Disable Refuge

Technical Specifications

Master Controllers	
Dimensions / Weight	W 422 x H 250 x D 80mm (base); W 435 x H 269 x D 11mm (Lid); 3.1kg
Paint Finish	Lid and Base RAL 7035 (Grey Texture)
Standby Battery requirements	2 x 12v 7Ah VRLA (valve regulated lead acid) connected in series
Mains Fuse / Battery Fuse	1A 20mm HRC / 1A 20mm
Max number of lines	8 (expandable to 16 if a slave unit is fitted) networking allows up to 64 line systems
Outstations per line	1
Outstation cabling requirements	2 core 1mm ² or 1.5mm ² enhanced fire rated cable, max. 1km/line max. cable resistance
Network Specifications	
Max no. of Master Panels per network	4 (providing 32 lines, or 64 lines if each Master Controller has a Slave Panel fitted)
Connection	Via Network Communication Card (one per networked master)
Network Cabling requirements	4 x 2 core 1.5mm ² enhanced fire rated cable, up to 1km in length
Anti Tamper Enclosure Dimensions	W 603 x H 465 x D 200mm
Expansion Units (CeI TEL Slave)	
Cabling requirements	2 x CAT 5 patch leads (supplied)
Dimensions / Weight	W 412 x H 250 x D 80mm (base); W 435 x H 269 x D 11mm (Lid); 3.1kg
Paint Finish	Lid and Base RAL 7035 (Grey Texture)
Disabled Refuge (Type B) Outstations	
Dimensions & Weight (Flush)	W 175 x H 250 x D 55mm (assembled); W 152 x H 228 x D 53mm (backbox); 1.4kg
Dimensions & Weight (Surface)	W 175 x H 240 x D 55mm (assembled); 1.4kg
Paint Finish	Stainless Steel facia, RAL 9005 (jet black) backbox
Dimensions (IP65 cabinet)	W 200 x H 298 x D 124mm approx (unassembled w/o handle fitted)
Fire Telephone (Type A) Outstations	
Dimensions & Weight (Push Door)	W 202 x H 278 x D 105mm; 3.8kg
Dimensions & Weight (Lift Lock)	W 202 x H 278 x D 125mm; 3.8kg

Product Codes

2572200	CeI TEL 4 Way Master EVC Panel with Handset and Display
2572201	CeI TEL 8 Way Master EVC Panel with Handset and Display
2572202	Master Controller without Handset
2572203	CeI TEL Slave EVC Panel with 8 Additional Lines
2572204	CeI TEL EVC Network Communication Card
2572206	Anti Tamper Enclosure for the CeI TEL Master EVC Panel
2572210	Type B Stainless Steel Flush Mounting Disabled Refuge Outstation
2572211	Type B Stainless Steel Surface Mounting Disabled Refuge Outstation
2572212	IP65 Enclosure for the Type B Surface Mounting Disabled Refuge Outstation
2572213	Type A Fire Telephone Outstation with Push Door
2572214	Type A Fire Telephone Outstation with Lift up Lock
2572215	Type B Green Flush Mounting Disabled Refuge Outstation
2572216	Type B Green Surface Mounting Disabled Refuge Outstation
2572217	Semi Flush Bezel for Type A Outstation
2572219	Disabled Persons Toilet Alarm

Water Leak Detection Alarms

The Water Leak detection system is a water detection system designed to be used in situations where not just flooding but also undue dampness could cause damage or ultimately become dangerous.

The system comprises an electronic monitoring and alarm control panel connected to sensors located in the area requiring protection and can be custom made with a variety of types of detection sensor to suit the characteristics of the areas to be covered.

This system has been designed for ease of installation and modern micro-electronics ensure a high degree of reliability.



DETEK Water Flood Detection Controllers

Controller electronics are housed in a robust cabinet and provide accurate sensing for water leakage and comprehensive alarm facilities. The system is ideal for all types of applications utilising a mixture of sensors on a single control panel to give optimum flexibility. All systems have a test facility to enable simple regular confidence checking of the equipment. Lockable cabinets constructed in mild steel with stove enamelled finish for surface mounting. 20mm Knockouts are provided for ease of cable entry.

Indications of status on each zone, wiring fault and supply healthy. Mains fail battery back-up indication where applicable. The 85dBA pulsed audible alarm has a fully functional local mute facility.

Technical Specification

Dimensions: 160H x 220W x 62D mm (Single Zone)
270H x 362W x 84D mm (Multi Zone)

Supply: Single phase 240VAC, 25VA

Max. Relay Contacts: Two sets of volt free change over contacts for alarm and one set for wiring fault or power loss. These may be used to link into Building Management Systems or for remote alarms and beacons up to 2A, 50Va.c./d.c.

Typical Applications:

- Computer Rooms, Telecommunications and Office Areas
- Electrical Plant and Tank Areas
- Valuables, Antiques and Artifacts
- In general, wherever the presence of water could be a potential problem to people, equipment, perishable stock, data/information archives and record stores, hospital theatres and so on.

There are also sensors for the detection of non-conductive fluids such as diesel/oil.

Features

- Suitable for computer rooms
- Wide range of sensors
- Relay contacts to interface to BMS or fire alarm controllers

Approvals:

- Electro Magnetic Compatibility - All of the control panels and sensors have been performance tested to meet the requirements of EN55022 for emissions and EN50092 for immunity.
- British International Standards - The equipment is manufactured in accordance with EN ISO 9001 procedures.
- Electrical Safety - Manufactured in accordance with Electrical Equipment (Safety) Regulations 1994 - Low Voltage Directive (SI 1994/3260).

Product Codes

508.200.004	1 Zone - water/flood control panel
508.200.005	2 Zone - water/flood control panel
508.200.006	4 Zone - water/flood control panel

Chapter 9 - Water Leak Detection

Sensor Cable

The Sensor cable comprises of high flexibility conductors insulated by Helagaine mono-filament braiding. Cable or tape sensors are suitable for general protection under false floors, or can be fastened directly to pipework enabling coverage in ceiling void areas.

The cables can be connected together, up to 100m, to cater for larger areas. For each zone a 'start of line' and an 'end of line' module is required.

Sensor Pads

Sensor pads are constructed from glass fibre with an anti-corrosive nickel plated surface. Pads will detect a few cc's of liquid and are either face up for location under vulnerable points or face down for general coverage.

Probe Sensors

Probe sensors are the least sensitive and are often employed as water level sensors. In general the sensor is enclosed in a protective cover which also provides a means for fixing and 20mm gland entry. The probe is designed for vertical mounting at skirting level though may be mounted in voids or sumps. A screw allows 16mm height adjustment after the sensor is installed.

CD5 & CD10 Sensing Cable



Technical Specification

Sensor Cable Dimensions: 8mm dia

Product Codes

516.200.010

CD/5 metre length of sensing cable

516.200.011

CD/10 10 metre length of sensing cable

SOL Start of Line for Sensing Cable



Product Code

516.200.012

SOL Start of Line for Sensing Cable

EOL End of Line for Sensing Cable



Product Code

516.200.013

EOL End of Line for Sensing Cable

SFD Sensor Pad - Face Down

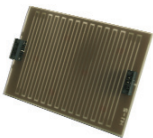

Technical Specification

Sensor Pads Dimensions:
115H x 160Wmm

Product Code

516.200.006

SFD Sensor Pad - Face Down

SFU Sensor Pad - Face Up



Technical Specification

Sensor Pads Dimensions:
115H x 160Wmm

Product Code

516.200.016

SFU Sensor Pad - Face Up

SFD/C Cover for Sensor Pad

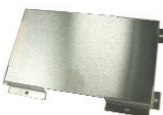

Technical Specification

Sensor Pads Dimensions:
115H x 160Wmm

Product Code

516.200.007

SFD/C Cover for Sensor Pad

Chapter 9 - Water Leak Detection

SPS/V Vertical Mount Probe Sensor c/w cover



Technical Specification

Probe Sensor Dimensions:
85H x 62W x 62Dmm

Product Code

516.200.004
SPS/V Vertical Mount Probe Sensor
c/w cover

FF1 Fixing Clips for Sensing Cable



Product Code

516.200.014
FF1 Fixing Clips for Sensing Cable

CDT Warning Labels for Sensing Cable



Product Code

516.200.015
CDT Warning Labels for Sensing
Cable

This page is left intentionally blank.

Special Hazards



Introduction

Tyco Fire Protection Products manufacturers and provides a wide range of equipment suitable for use in hazardous areas where normal equipment cannot be safely used. The range extends from IS detectors for use on conventional systems to flameproof and I.S. flame detectors for use in the most demanding of environments.

A complete range of Barriers, Housings, Callpoints and Sounders are available to fully support the product range.

Electrical equipment supplied for use in Hazardous Areas must comply with rigid requirements to ensure that its introduction into the area does not increase the existing risk. We have designed Intrinsically Safe (I.S.) systems and equipment for use in Hazardous Areas which can be connected to Fire Detection Systems installed in Safe Areas.

There are two I.S. systems used. System 620 for use in conventional fire detection circuits and System 800 for use with MINERVA MX digital addressable circuits. The control equipment of the fire detection system must be connected either via a Shunt Diode Safety Barrier or by an Isolating Interface to System 620 and System 800.

Two Sounder Systems (one earthed and one isolated) are available for use with System 620 and System 800.

APPLICATION - GENERAL

The System Designer must be familiar with BS EN 60079-14: 2003, EN 50, EN 50020 and ATEX certification and have successfully completed an appropriate recognised course in Intrinsic Safety.

Design of the system requires that the designer has all the information concerning the installation correctly documented.

The nature of the Hazard must be defined by the customer and a survey carried out to determine the proximity of the safe area to establish cable runs. The probability of a flammable mixture being present is defined by a Zone Number. Flammable gases are classified in Groups and their minimum spontaneous ignition temperature is categorised by Class. Equipment marked EExe ia IIC T5 would be suitable for use in worst case conditions, e.g. Zone 0 (ia), Hydrogen (IIC), T5 (100 deg C).

The Fire Alarm Equipment and Safety Barriers should be placed as near as possible to the containment wall of the Hazardous Area. This minimises the cable lengths between the barrier and the Hazardous Area and thus the capacity to store energy.

In order that an Installation will comply with the ATEX certification designated for each system it is essential that the certified devices are connected with cables of the specified limits. These limits have been certified for specific classifications of hazard in order that energy storage is limited.

Safety Barriers are incorporated into the circuit feeding the Hazardous Area to limit the voltage excursion and the current. The limit of voltage and current will prevent a fault within the I.S. circuit exceeding the ignition conditions.

THE FITTING OF SAFETY BARRIERS, ISOLATING INTERFACES OR SOUNDER DRIVERS DOES NOT IN ITSELF MAKE A CIRCUIT TO WHICH THEY ARE CONNECTED INTRINSICALLY SAFE.

Chapter 10 - Special Hazards

APPLICATION - HAZARDOUS AREA

A Hazardous Area is defined as one where in the presence of a flammable mixture, ignition may cause an explosion. There is a risk of an explosion when substances (whether liquid, gas, vapour, dust, powder, or solid) are mixed with air to form a flammable atmosphere.

To prevent the possibility of ignition in flammable atmospheres special precautions for the construction and use of electrical apparatus is required. One method of construction and use is defined as INTRINSICALLY SAFE.

APPLICATION - INTRINSIC SAFETY

To preclude the risk of an explosion, equipment in the Hazardous Area must not be capable of causing ignition under normal operating, or specific fault conditions. Limiting the energy which can be stored in, and released by, electronic circuitry and cables in the Hazardous Area is achieved by using Intrinsically Safe equipment and by placing restrictions on the cable parameters.

To complete the explosion protection concept of a circuit a Safety Barrier must be connected between the Hazardous Area equipment and the source of power in the Safe Area. The electrical power which may be supplied or drawn from a Safe Area (i.e. an area with no definable hazard) is limited by using Shunt-Diode Safety Barriers or Isolating I.S. Interface Units.

Connection of the Hazardous Area equipment to the Safety Barrier must comply with the limitations listed in the System Certification. These limits have been certified for specific classifications of hazard in order that energy storage in the cables is limited. If the Electrical Energy in a circuit is less than the value required to ignite a potentially explosive mixture then the circuit is said to be INTRINSICALLY SAFE.

APPLICATION - GALVANIC ISOLATORS

Galvanic isolators protect the integrity of an Intrinsically Safe circuit under "Fault" conditions.

Galvanic isolators operate in a fully floating electrically isolated condition, no High Integrity I.S. earth is required.

SHUNT-DIODE SAFETY BARRIERS AND INTERFACE UNITS

A Shunt-Diode Safety Barrier, Isolating I.S. Interface Unit, or Isolating Sounder Driver protects the integrity of an Intrinsically Safe circuit under 'Fault' conditions. The over-voltage protection provided by a Shunt-Diode Safety Barrier is with reference to the safety barrier earth connection. It is therefore imperative that a HIGH INTEGRITY EARTH is used for this type of barrier.

A High Integrity Earth is a current sink of nominally zero impedance capable of passing a fault current without compromising the function of the Shunt-Diode Safety Barrier. Connection to this earth and the barrier earth must not be more than 1 ohm and not less than 4mm² cross section area.

Several types of safety barrier are commercially available and include Single circuit and Dual circuit Shunt-diode, and galvanically isolating types. The Shunt-diode type requires a High Integrity Earth connection and the galvanically Isolating type operates in a fully floating electrically isolated condition; no High Integrity I.S. earth is required.

A Shunt-Diode Safety Barrier DOES NOT make a circuit to which it is connected Intrinsically Safe.

CERTIFICATION

The design and construction of the equipment that may be installed in a Hazardous Area is controlled by a scheme of inspection and certification to the EU ATEX Directive 94/9/EC. The inspection and certification is carried out by an approved ATEX notified body.

Designers are licensed to reproduce the marks on equipment that complies with the Certification listed in its License Number.

Only ATEX approved barriers/isolators and intrinsically safe hazardous area equipment may be used.

Special Hazard Flame Detectors



Features

- ATEX, IECEX & FM approved
- Fast, reliable flame detection using multi-infrared detection
- Simplifies alarm handling for remote control room situations
- Provides immediate visual ID of alarm location
- Robust stainless steel housing with heated window
- Automatic monitoring of detector functionality
- 256 cell infrared sensor array monitoring the field of view to separately identify flame and non flame sources
- Range of integral interface options
- Masking of part of field of view with software configuration tool
- 60m detection range with 90° field of view
- Remote video monitoring with fire location and detector information
- Automatic optical path monitoring
- History Log stored in detector

FV300 Array Based Flame Detectors - IEC 61508 Approved (SIL2)

The FlameVision FV300 is a range of detectors that use a 256 cell multi-infrared array, to detect flame and provide positional information so that the location of a flame within the detector's field of view can be communicated. Additionally, an inbuilt CCTV camera can transmit a "detector's eye view" of the protected area to a CCTV monitor. Superimposed onto the CCTV picture will be the positional data highlighting exactly where the source of alarm is coming from.

An angle of view of 90 degrees on the horizontal plane has been achieved with little or no reduction in sensitivity over the entire field. A pan fire covering one-tenth of a square metre can be detected by the FlameVision FV300 at a range of 60 metres. Such a small fire at that range would not normally be visible on a CCTV picture. The superimposed positional data on the CCTV display highlights and identifies the source of the alarm. This can save precious time and allow executive actions to take place at the earliest opportunity thus minimising potential fire losses.

Markets:

The FlameVision FV300 detectors are intended for applications demanding a high level of protection and where a rapid response to fire is important.

Typical applications are:

- Refineries
- Drilling and production plants
- Fuel loading facilities
- Compressor stations
- LNG/LPG processing & storage
- Gas turbines
- Chemical production
- Aircraft hangars
- Waste management/transfer
- Sports stadiums
- Tank farms
- Printing industry
- Warehousing
- Munitions storage

Range of Interfaces:

As standard the FV300 is supplied with the following interfaces:

- Fire and fault relays, programmable as normally open or normally closed
- 4 to 20mA analogue current output, proportional to the flame detection signal (sink or source)
- RS485 serial data port suitable for network connection using a MODBUS protocol. This can be used to communicate the positional co-ordinates of a flame within the field of view of the detector
- Video output compatible with twisted pair video cable

FlameVision Models:

There are five FlameVision models in the FV300 detector range. There are models with and without cameras. Each model is also supplied either with a sealed back-box and a pre-connected 3m length of cable or with two threaded cable gland entries.

FV300 Flame Detector Model Nos.	Cable gland entries	Sealed back-box
No camera	FV311S	FV312S
PAL Format camera	FV311SC	FV312SC
NSTC Format camera	FV311SC-N	

Chapter 10 - Special Hazards

Technical Specification

Mechanical Characteristics

Dimensions

Height:	138.8 mm
Width:	152.8 mm
Depth:	91.7 mm
Weight:	3.96 kg
Mounting bracket weight:	1.54 kg

Materials

Enclosure:	Stainless Steel 316L, ANC4BFCLC to BS 3146: Part 2
Detection window:	Sapphire
Camera window:	Toughened glass
Guard/label plate:	Stainless Steel 316S16 to BS 1449: Part 2
Mounting bracket:	Stainless Steel 316S16 to BS 1449: Part 2
Screws etc. exposed to the elements:	Stainless Steel 316 A4

Electronic modules Fibreglass substrate

Electrical access

FV311 Series detectors: Standard M20 gland holes (two)
FV312 Series detectors: Multi twisted pair screened cable

Environmental Temp. Humidity, Enclosure Protection and Pressure

Operating temp. range without camera:	- 40°C to + 80°C
Operating temp. range with camera:	- 10°C to + 55°C
Maximum withstand temp:	120°C (for 10 minutes)
Storage temp. range:	- 40°C to + 80°C
Relative humidity:	Up to 99% (non condensing)
Enclosure protection:	Tested to IP66 and IP67
Normal operating atmospheric press:	910 mbar to 1055 mbar
Heat radiation from sun:	0 to 1kWm ² typical

Product Codes

516.300.006	FV311S Flameproof Detector - cable gland entries - no camera
516.300.008	FV311SC Flameproof Detector - cable gland entries - PAL camera
516.300.007	FV311SC-N Flameproof Detector - cable gland entries - NTSC camera
516.300.055	FV312S Flameproof Detector - sealed back box - no camera
516.300.057	FV312SC Flameproof Detector - sealed back box - PAL camera
517.300.001	MB300 Mounting Bracket
517.300.002	WH300 Stainless Steel Weather Hood
517.300.005	JB300 Exe Junction Box
517.300.006	MK300 Field Spares Kit
517.300.021	WT300 Walk-test Controller
517.300.022	CTI300 Off-line Configuration Tool Kit



Features

- Triple waveband infrared solar blind flame detection for optimum false alarm immunity
- Unrivalled black body rejection over a wide range of source temperatures
- Range adjustable to 50 metres for a 0.1m² petrol pan fire
- Discrimination of optical faults (dirty windows) from other faults by the built-in self test feature
- Housing designed for easy installation of cabling
- Models also available with relay or 4-20mA outputs
- Patented dual filter for complete solar blindness
- 100° field of view on IS versions
- 90° field of view on Flameproof versions
- ATEX, IECEX & FM Approval

S200 Plus Triple IR Solar Blind Flame Detector

Unlike other flame detectors on the market the MINERVA S200 PLUS is available in both Intrinsically Safe (EEx ia) and Flameproof (EEx d) models.

The intrinsically safe models are suffixed by the letter " i " and are ATEX Certified EEx ia IIC T5. As part of an intrinsically safe circuit, it is suitable for zones 0,1 and 2 where group IIC gases or lesser hazards can be continuously present in explosive concentrations.

The flameproof models are suffixed by the letter " f " and are ATEX Certified EEx d IIC T6. The detectors are suitable for zones 1 and 2 where group IIC gases or lesser hazards can be intermittently present in explosive concentrations.

Technical Specification

Detector Material:	Stainless Steel 316L/316
Dimensions:	167H x 167W x 89D MM
Weight:	4.5Kg
Gland Entry:	2 x 20mm
Range:	0.1m ² petrol at 50m 0.4m ² petrol at 60m
Operating Temp:	
Intrinsically Safe=	- 40° c to +80° c (IECEX & ATEX)
Flame Proof=	- 20° c to +60° c/+80° c (IECEX/ATEX)
Response Time:	Field Selectable 3, 6 and 12s
Sensitivity:	3 range settings
Relative Humidity:	95% (100% intermittent)
Enclosure:	IP 66 and IP 67

Product Codes

517.001.266	S200+ Spares Kit & Sealant
517.001.263	S200+ Weather Protection Assembly
517.001.184	S200+ Detector Mounting Bracket

Datasheet - Product Code **PSF102U** "Minerva S200 Plus Series"

Approvals

Various models are certified by a number of approval bodies including those listed below.

ATEX Approved models have a suffix '1' as the third digit.
FM Approved models have a suffix '2' as the third digit.



MANAGING RISK



APPROVED



S200 Plus Triple IR Solar Blind Flame Detector

Additional Features

- Flexible mounting and angular adjustment
- 2 x 20mm field cable entries
- IP66/67 housing designed for external use
- Rugged 316 stainless steel housing and mounting bracket
- Variable response times and sensitivity settings
- Remote self test and range setting
- True window test in detection area (i.e. not in the edge of the window)
- Terminals provided for Remote LED connection where relevant
- BASEEFA (CENELEC) certified
- Approved to EN54 Pt 10 (Except FV282F)
- IEC 61508 Approved (SIL2)
- FM, DNV and LRS certified
- Very low power consumption (0.35mA)
- Models available with Conventional or Analogue Addressable interface (requires 2 core cable only)

	Interface				Approvals			Product Codes
					ATEX		FM	
	Conventional	4-20mA	MZX Addressable	Relay	Ex 'ia'	Ex 'd'	Ex 'd'	
S231i+	✓				✓			516.037.004
S231f+	✓					✓		516.037.003
S232f+	✓						✓	516.037.015
S241i+		✓			✓			516.038.004
S241f+		✓				✓		516.038.003
S261f+				✓		✓		516.040.002
S271i+			✓		✓			516.041.004
S271f+			✓			✓		516.041.003
FV282F+		✓		✓			✓	516.040.014

System 800 Fire Detection for Hazardous Areas



Features

- Addressable I.S. MX Technology
- Compatible with S271i+ flame detector
- Compatible I.S. callpoint.
- ATEX certified intrinsically safe Ex II 1 GD System
- Suitable for use in Zone 0, 1, 2, 20, 21 & 22

System 800 Fire Detection for Hazardous Areas

A complete range of ATEX and ITEX certified detectors suitable for use in Zone 0, 1, 2, 20, 21 & 22 Areas. MX digital addressable for use on Minerva MX Fire Controllers.

There is a risk of fire or explosion in all areas containing flammable substances in the form of liquids, gasses, dust or materials. Where these combustible materials are mixed with air in sufficient concentration they form a flammable atmosphere and the areas containing them are designated Hazardous Areas. When a source of ignition, such as a spark, is applied in a hazardous area, an explosion could take place. Electrical equipment supplied for use in Hazardous Areas must comply with requirements to ensure that its introduction into the area does not increase the existing risk. System 800 is an MX Technology™ Intrinsically Safe (I.S) system for use in Hazardous Areas which can be connected to the MX Fire Detection Systems installed in the Safe Areas.

The System designer must be familiar with ATEX certification and have successfully completed an appropriate recognised course in Intrinsic Safety. Design of the system requires that the designer has all the information concerning the installation correctly documented. The nature of the hazard must be defined by the customer and a survey carried out to determine the proximity of the safe area to establish cable runs.

The probability of a flammable mixture being present is defined by a zone number. Flammable gasses are classified in Groups and their minimum spontaneous ignition temperature is categorised by Class. Tyco Fire Protection Products supplied equipment marked EEx ia IIC T5 would be suitable for use in worst case conditions. E.G. Zone 0 (ia), Hydrogen (IIC), T5 (100 deg C). The Fire Alarm Equipment and Safety Barriers should be placed as near as possible to the containment wall of the Hazardous Area. This minimises the cable lengths between the barrier and the Hazardous Area and thus the capacity to store energy.

In order that an Installation will comply with the ATEX certification designated for each system, it is essential that the certified devices are connected with cables of the specified limits. These limits have been certified for specific classifications of hazard in order that energy storage is limited.

The number of devices connected to the barrier and located in the Hazardous Area must always be limited to not more than the listed maximum.

The use of the MX designer Software tool will ensure correct loop loading and it's use is essential to the design process.

System 800 is for use in MX Technology Addressable Fire detection circuits.

[Datasheet PSF129U](#)
[Manual 17A-02-DETEX](#)

Chapter 10 - Special Hazards

801PHEx/811PHExn Smoke and Heat Detector



The 801PHEx/811PHExn Optical Smoke & Heat Detectors form part of the 800Ex Series of MX Addressable Fire Detectors. The detector plugs into the 5BEX base.

The mode of detector may be:

- Optical smoke only detector (sensitivity - High, Normal or Low)
- HPO smoke detector (sensitivity - High, Normal or Low)
- Heat only rate-of-rise (A1R) detector (no sensitivity selection)
- Heat fixed temperature 60°C (A2S no sensitivity selection)
- Optical (sensitivity - High, Normal

or Low) combined with heat fixed temperature 60°C (A2S)

- HPO (sensitivity - High, Normal or Low) combined with heat fixed temperature 60°C (A2S)

Technical Specification

ATEX Code:
Ex ia EX II 1GD
Exn EX II 3G
Cenelec Code:
Ex ia IIC T5/Ex iaD 20 T100°C/
EExnA II T4
Weight:
0.2Kg detector and base (approx)
Operating Temp. Range:
-25°C to +70°C

Storage Temp:
-40°C to +70°C
Relative Humidity:
95% non- condensing

Product Codes

516.800.530
801PHEx Optical Smoke + Heat Detector
516.800.534
811PHExn Marine Optical Smoke + Heat Detector
*Manual Vol 17A-02-PHExn
17A-02-PHEx*

801CHEx/811CHExn CO & Heat Detector



The 801CHEx/811CHExn Carbon Monoxide plus Heat Detector form part of the 800Ex Series of MX Addressable Fire Detectors. The detector plugs into the 5BEX base.

The mode of detector may be:

- Heat only detector (A1R or A2S) (sensitivity: - High, Normal or Low)
- Compensated Carbon Monoxide detector (sensitivity: - High, Normal or Low)
- Compensated Carbon Monoxide detector (sensitivity: - High or Normal) combined with heat (A1R)

Technical Specification

ATEX Code:
Ex ia EX II 1GD
Exn EX II 3G
Cenelec Code:
Ex ia IIC T5/Ex iaD 20 T100°C/
EExnA II T4
Weight:
0.2Kg detector and base (approx)
Operating Temp. Range:
0°C to +55°C/-20°C to +40°C
Storage Temp:
-20°C to +55°C
Relative Humidity:
95% non condensing

Product Codes

516.800.531
801CHEx Carbon Monoxide + Heat Detector
516.800.535
811CHExn Marine Carbon Monoxide + Heat Detector
*Manual Vol 17A-02-CHExn
17A-02-CHEx*

801HEx/811HExn Heat Detector



The 801HEx/811HExn Heat Detectors form part of the 800Ex Series of MX Addressable Fire Detectors. The detector plugs into the 5BEX base.

The mode of detector may be:

- EN54-5 A1R, rate-of- rise normal ambient
- EN54-5 A2S, fixed 60°C
- EN54-5 CR, rate-of-rise high ambient

Technical Specification

ATEX Code:
Ex ia EX II 1GD
Exn EX II 3G
Cenelec Code:
Ex ia IIC T5/Ex iaD 20 T100°C/
EExnA II T4
Weight:
0.2Kg detector and base (approx)
Operating Temp. Range:
-25°C to +70°C
Storage Temp:
-40°C to +70°C/-40°C to +80°C
Relative Humidity:
95% non-condensing

Product Codes

516.800.532
801HEx Heat Detector
516.800.536
811HExn Marine Heat Detector
*Manual Vol 17A-02-HExn
17A-02-HEx*

801FEx Flame Detector



The 801FEx point type flame detector forms part of the MX Technology® range of digital addressable fire detectors. The detector plugs into the 5BEX base.

The 801FEx is a full featured solar blind flame detector and can detect a 0.1m² fire at a range of 20m.

Technical Specification

ATEX Code: Ex II 1GD
Cenelec Code: Ex ia IIC T4/
Ex iaD 20 T135°C
Weight:
0.2Kg detector and base (approx)
Operating Temp. Range:
-20°C to +70°C
Storage Temp:
-40°C to +80°C
Relative Humidity:
90% non-condensing

Product Codes

516.800.066
801FEx I.R. Flame Detector
516.800.067
811FEx Marine I.R. Flame Detector
Manual Vol 17A-02-FEX

IS28 Mark 5 Banshee Electronic Sounder



The IS28 Mark 5 Banshee Electronic Sounder is the industry standard intrinsically safe sounder for use in hazardous gas and dust environments. This traditional high profile Banshee Electronic Sounder has 32 tones providing ultimate flexibility and is designed to be connected directly to the 24Vdc sounder circuit of an addressable Fire Alarm Control Panel via an MTL5525 Safety Barrier.

Please Note:-

1. The IS28 Mark 5 Banshee Electronic Sounder must only be used with the MTL5525 Sounder Driver (517.001.304) and not be connected to any other type of Sounder Driver (barrier) new or existing on the system.
2. Nothing else must be connected to the MTL5525 except IS28 Mark 5 Banshee Electronic Sounders (maximum of 3 per barrier, irrespective of the selected tone).

Technical Specification

- Intrinsically Safe for use in hazardous gas and dust environments
- ATEX Approved: Ex II 1GD (Certificate Number ITS10ATEX27151X)
- IECEx Approved: Certificate Number IECEx ITS 10.0050X
- Gas Code: Ex ia IIC T5
- Dust Code: Ex ia IIIC T100oC
- Ingress Protection to IP66
- Choice of 32 Selectable Tones
- Choice of 3 Volume Settings
- 2 x 20mm Cable Entry Knockouts

Product Code

576.501.017

IS28 Mark 5 Banshee Sounder

CP840Ex Break Glass Call Point



The CP840Ex Weatherproof Break Glass Call Point is designed to monitor and signal the condition of a switch contact associated with the break glass.

Technical Specification

ATEX Code: Ex II 1GD
 Cenelec Code: Ex ia IIC T5/Ex iaD 20 T100°C
 Operating Temp Range: -25°C to +70°C
 Storage Temp: -30°C to +70°C
 Relative Humidity: Up to 95% RH non condensing

Product Code

514.800.513

CP840Ex MX Digital Addressable Break Glass Call Point

Manual Vol 17A-02-CPEX

CP830Exn Break Glass Call Point



The CP830Exn Weatherproof Break Glass Call Point is designed to monitor and signal the condition of a switch contact associated with the break glass.

Technical Specification

ATEX Code: Ex II 3G
 Cenelec Code: EEx nL IIC T4 (-20°C ≤ Ta ≤ +40°C)
 Operating Temp Range: -25°C to +70°C
 Storage Temp: -40°C to +80°C
 Relative Humidity: Up to 95% RH non condensing

Product Code

514.800.514

CP830Exn Marine MX Digital Addressable Break Glass Call Point

Manual Vol 17A-02-CP830Exn

IF800Ex Interface Module



The Intrinsically Safe IF800EX Interface Module is designed to monitor fire contacts such as sprinkler flow switches. The IF800EX is contained within a grey compression moulded glass filled polyester box with 2 x 20mm cable gland holes.

The electronic components are mounted on a double sided printed circuit board built into a potted module formed from a plastic moulding. Connectivity is via two terminal blocks fitted to the PCB.

Technical Specification

ATEX Code: Ex II 1GD
 Cenelec Code: EEx ia IIC T5

Product Code

514.001.062

IF800Ex MX Digital Addressable Interface Module Assembly

Manual Vol 17A-02-IFEX

Chapter 10 - Special Hazards

EXI800 Interface Module & Galvanic Isolators



The EXI800 Interface Module when used with a galvanic isolator, provides a path for an MX panel to transparently communicate to slave devices (800Ex Detectors, IF800Ex Interface Module or CP840Ex Addressable Break Glass Call Point) connected to the Intrinsically Safe Loop. The EXI800 interface reduces the standard MX loop supply voltage and signalling currents to levels that are acceptable for hazardous areas. The EXI800 can detect a short circuit on the left-loop, the right-loop, or the IS spur and will isolate the offending circuit from the other loop connections.

The IS loop output of the EXI800 interfaces with the Pepperl & Fuchs KFDO-CS-Ex1.54 Galvanic Isolator supplying loop voltage and signalling currents to the Intrinsically Safe Loop. The EXI800 is supplied complete with a service tool EX dangle that is required to activate the address programming when using the standard MX service tool. The MTL5525 Isolating Sounder Driver enables an intrinsically safe sounder located in the hazardous area, to be controlled from the safe area. The MTL5525 has one channel and is suitable for connecting certified loads in Zone 0, IIC, T4-T6 hazardous areas.

Product Codes

514.001.063
EXI800 Interface Module
517.001.259
Pepperl & Fuchs KFDO-CS-
EX1.54 Galvanic Isolator
517.001.304
MTL5525 I.S. Sounder Driver

Manual Vol 17A-02-EXI

IS Barrier Enclosure



The MTL 'DX' Series enclosures will house the EXI800 (20mm pitch), Pepperl & Fuchs KFDO-CS-Ex1.54 Galvanic Isolator (20mm pitch) and the MTL5525 I.S. Sounder Driver (16.2mm pitch). The units are DIN rail mounted with 70mm of rail supplied with the DX070 and 170mm of rail with the DX170. The enclosures are usually selected on the number of units they will accommodate. The following table shows the capacity of each of the enclosure types.

Product Codes

517.001.248
DX070 Enclosure
517.001.247
DX170 Enclosure

Enclosure	MTL5500 isolators 16.2mm Pitch	MTL7700 barriers 7.5mm Pitch
DX070	4 (2*)	9 (5*)
DX170	10 (8*)	22 (18*)

* Use these figures when two IMB57 mounting brackets for tagging/earth rail accessories are included.

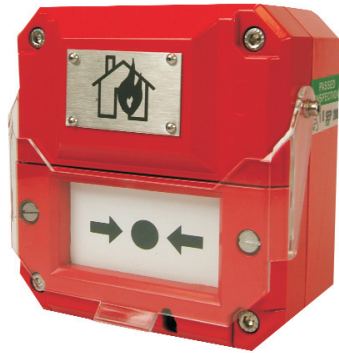

Features

- Glass Reinforced Polyester Enclosure – light, strong and not subject to corrosion.
- Resettable Element.
- Explosion protected EExe (ATEX Approved).
- In line and end of line resistors.
- Red Epoxy Finish.
- 7 x terminals.
- Lift flap for extra protection against inadvertent operation.
- 1 x changeover switch.
- Captive cover screws.
- Key operated test facility – simple but secure.
- 1 x M20 bottom cable entry.

BG MIM800 Callpoint EX II 2 GD

An Ex II 2 GD Dust Approved & Increased Safety (EExemd) Resettable Manual Alarm Call Point for use with the EExd Flameproof MIM800 input module in EExd housing on an Addressable Detection & Releasing System in gas and dust explosive risks.

Please note that the above part is only compatible with Consys Version 17.0 and above when used with 577.800.067.

Technical Specification

Protection:	Explosion Protected EExed(Increased Safety)
Certification:	ATEX approved Ex II 2 GD BAS02ATEX2105X EExemdIICT4 CENELEC EN50014 EN50019 EN50018 EN50028 Suitable for use in Zones 1 & 2
Voltage:	Up to 250V
Certified Temperature:	-20°C to +50°C
Ingress Protection:	IP66 & 67
Terminals:	7 x 2.5mm ²
Switch Ratings(1 x Changeover):	DC 0-30V 5A (Resistive) or 3A (Inductive) DC 30-50V 1A Resistive or Inductive AC 0-254V 5A Resistive or Inductive
Cable Entries:	1 x M20 Bottom
Weight:	1.2Kg
Material:	Anti Static U.V. Resistant Glass Reinforced Polyester
Finish:	Red Epoxy Paint
Resistors:	Alarm: 100 Ohm EOL: 250 Ohm
Labelling:	Burning House Symbol
Dimensions (W X H X D):	120mm x 126mm x 75mm

Product Code

514.001.107	EX II 2 GD Dust Approved & Increased Safety (EExemd) Resettable Manual Alarm Callpoint
-------------	--

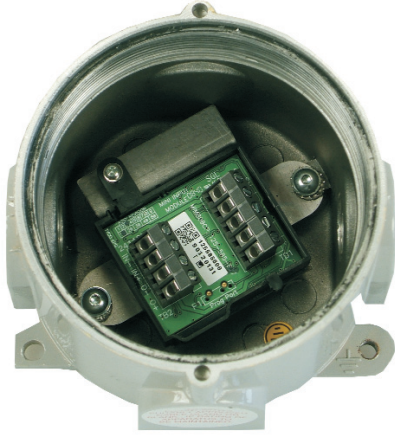

Features

- Copper Free Metal Alloy Aluminium Housing
- Explosion Protected to EExd (ATEX Approved)
- 9 x Terminals
- 3 x M20 Cable Entries
- Fast Interrupt Mode for Call Points

MIM800 Input Module in EExd Housing

An EExd Flameproof MIM800 Addressable Module for extending the monitoring of Call Points and other Alarm Inputs on an MX, ZX and MZX Addressable System in gas and dust explosive risks.

Please note that the above part is only compatible with Consys Version 17.0 and above when used with 514.001.107.

Technical Specification

Protection:	Explosion Protected EExd (Flameproof)
Certification:	Ex II 2 GD LOM02ATEX2037 EExdIICT6 CENELEC EN50014 EN50018 EN50019 EN50281-1-1 EN60439-1 Suitable for use in Zones 1 and 2 to IEC 60079-10 Suitable for use in Zones 21 and 22 to EN50281-3
Voltage:	40Vdc
Certified Temperature:	-20°C to +55°C
Ingress Protection:	IP67
Terminals:	9 x 2.5mm ²
Cable Entries:	3 x M20 (No Blanking Plugs)
Weight:	0.8 Kg
Material:	Metal Alloy Aluminium - Copper Free
Dimensions (W X H X D):	108mm x 98mm x 90mm

Product Code

577.800.067 MIM800 Input Module in EExd Housing



Features

- Allows the DDM800 to be mounted in a Hazardous Area.
- Allows the monitoring of Call Points and other Alarm Inputs (including 4-20mA devices) designed for use in Hazardous Areas on an MX, ZX and MZX Addressable System in gas and dust explosive risks.
- Approved for use in Gas Zone 1 and 2.
- Approved for use in Dust Zone 21 and 22.
- Copper Free Metal Alloy Aluminium Housing.
- Explosion Protected to EExd (ATEX Approved).
- 5 x M20 Cable Entries (3 x bottom and one each side).

DDM800 Fire & Gas Detector Module in EExd Housing

A DDM800 Fire and Gas Detector Module in a EExd Housing for use in special hazardous area applications.

The DDM800 Universal Fire and Gas Detection Module is a detector module designed to interface a wide range of conventional fire detectors to MZX Technology® control panels.

Additionally the option is available to connect two 4 to 20mA devices and to configure the alarm thresholds within the control panel.

The DDM800 is supported by MXConsys® Version 15 and above and Issue 6 MXDesigner. It is recommended that MXDesigner is used for all system designs using DDM800 modules. For detailed design and application details, please refer to document "DDM800 Universal Fire & Gas Detector Module Product Application and Design Information" reference 17A-02-DDM.

Technical Specification

Protection:	Explosion Protected EExd (Flameproof)
Certification:	Ex II 2 GD LOM02ATEX2037 EExdIICT6 CENELEC EN50014 EN50018 EN50019 EN50281-1-1 EN60439-1 Suitable for use in Zones 1 and 2 to IEC 60079-10 Suitable for use in Zones 21 and 22 to EN50281-3
Voltage:	40Vdc
Certified Temperature:	-20°C to +55°C
Ingress Protection:	IP67
Terminals:	12 x 2.5mm ²
Cable Entries:	5 x M20 (3 Blanking Plugs Supplied)
Weight:	1.3 Kg
Material:	Metal Alloy Aluminium - Copper Free
Dimensions (W X H X D):	150mm x 150mm x 104mm

Product Code

577.800.066	DDM800 Fire & Gas Detector Module in EExd Housing
-------------	---

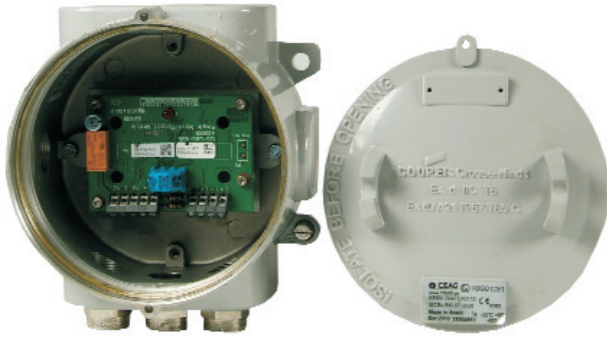

Features

- Allows the SIO800 to be mounted in a Hazardous Area.
- Allows the status of a normally open contact to be monitored and/or a volt free change over relay output in a Hazardous Area to be interfaced onto an MX, ZX and MZX Addressable System in a gas and dust explosive risk.
- Approved for use in Gas Zone 1 and 2.
- Approved for use in Dust Zone 21 and 22.
- Copper Free Metal Alloy Aluminium Housing.
- Explosion Protected to EExd (ATEX Approved).
- 5 x M20 Cable Entries (3 x bottom fitted with blanking plugs and one each side supplied open).

SIO800 I/O Module in EExd Housing

The SIO800 Single Input/Output Module is designed to monitor a normally open contact input and provide a volt free changeover relay output. This enables inputs and outputs from hazardous area devices to be easily interfaced to the MX, MZX, MX2, T2000 and ZX Range of Control Panels.

Technical Specification

Protection:	Explosion Protected EExd (Flameproof)
Certification:	Ex II 2 GD KEMA 09ATEX0110 EExdIICT6 CENELEC EN50014 EN50018 EN50019 EN50281-1-1 EN60439-1 Suitable for use in Zones 1 and 2 to IEC 60079-10 Suitable for use in Zones 21 and 22 to EN50281-3
Voltage:	40Vdc
Certified Temperature:	-20°C to +55°C
Ingress Protection:	IP67
Terminals:	9 x 2.5mm ²
Cable Entries:	5 x M20
Weight:	1.64 Kg
Material:	Metal Alloy Aluminium - Copper Free
Dimensions (W X H X D):	150mm x 150mm x 104mm

Product Code

555.800.072	SIO800 Single Input/Output Module in EExd Housing
-------------	---

System 620 Fire Detection for Hazardous Areas



Features

- Conventional I.S. system
- Suitable for worst case (EEx ia IIC T5)
- High Performance Optical (HPO) smoke detector
- Compatible with S231i+ flame detector
- Compatible I.S. callpoint
- Suitable for use in Zone 0,1,2,20,21 & 22

System 620 Fire Detection

A complete range of ATEX and IECX certified detectors suitable for use in Zones 0,1,2,20,21 & 22 areas for use on conventional panels. There is a risk of fire or explosion in all areas containing flammable substances in the form of liquids, gasses, dust or materials. Where these combustible materials are mixed with air in sufficient concentration they form a flammable atmosphere and the areas containing them are designated Hazardous Areas. When a source of ignition, such as a spark, is applied in a hazardous area, an explosion could take place. Electrical equipment supplied for use in Hazardous Areas must comply with requirements to ensure that its introduction into the area does not increase the existing risk. System 620 is an Intrinsically Safe (I.S.) system for use in Hazardous Areas which can be connected to a conventional fire Alarm Controller installed in the Safe Area.

The System Designer must be familiar with ATEX certification and have successfully completed an appropriate recognised course in Intrinsic Safety. Design of the system requires that the designer has all the information concerning the installation correctly documented. The nature of the hazard must be defined by the customer and a survey carried out to determine the proximity of the safe area to establish cable runs.

The probability of a flammable mixture being present is defined by a Zone Number. Flammable gases are classified in Groups and their minimum spontaneous ignition temperature is categorised by Class. Tyco Fire Protection Products supplied equipment marked EEx ia IIC T5 would be suitable for use in worst case conditions. Eg. Zone 0 (ia), Hydrogen (IIC), T5 (100 deg C). The Fire Alarm Equipment and Safety Barriers should be placed as near as possible to the containment wall of the Hazardous Area. This minimises the cable lengths between the barrier and the Hazardous Area and thus the capacity to store energy.

In order that an Installation will comply with the ATEX certification designated for each system it is essential that the certified devices are connected with cables of the specified limits. These limits have been certified for specific classifications of hazard in order that energy storage is limited.

The number of devices connected to the barrier and located in the Hazardous Area must always be limited to not more than the listed maximum.

When a mixture of devices is connected to any one zone the numbers must be reduced in proportion to the ratio of the load presented to the barrier. When a System includes the use of an S231i+, it must be remembered that the load it presents to the circuit is twice that of a detector. A mixture of large and small load devices connected to a zone will require a calculation for the number of allowed detectors.

System 620

System 620 is for use in conventional fire detection circuits. Two Sounder Systems, (one earthed and one isolated), are available and either can be used with System 620.

[Datasheet - PSF122U](#)

Chapter 10 - Special Hazards

High Performance Optical Smoke



The MR601TEX has been developed to overcome the slower response of the optical detectors to hot burning fires, by increasing the sensitivity of the optical detector when it is associated with a rapid change in temperature. In this way it is intended to become a detector which can cover some of the risks currently covered by ion chamber detectors. Smoke detectors will not detect burning alcohol or other clean

burning liquids which do not generate smoke particles.

ATEX Code: Ex II 1GD
Cenelec Code: Ex ia IIC T5/
Ex iaD 20
T100°C
Operating Temp Range: -20°C to +70°C
Storage Temp: -25°C to +80°C
Relative Humidity: 95% non-condensing

Product Code

516.054.011.Y (Vol 01B-04-D12)
MR601TEX Conventional High Performance Optical Smoke Detector

Heat Detectors



If environmental conditions rule out the use of smoke detectors, then a heat detector of the type MD601EX/MD611EX may provide an acceptable, though less sensitive, alternative. For general use, and particularly where the ambient temperature may be low, a 'Rate-of-Rise' heat sensor is to be preferred. This type of sensor reacts to abnormally high rates of change of temperature and provides the fastest response over a wide range of ambient temperatures. A fixed temperature limit is also incorporated in these detectors. In many environments, e.g. kitchens and boil-

er rooms, sudden, large changes in temperature are considered 'normal'. Rate-of-rise detectors are generally not suitable in these cases and fixed temperature [static] types should be used.

ATEX Code : Ex II 1GD
Cenelec Code: Ex ia IIC T5/
Ex iaD 20
T100°C
Operating Temp Range: -20°C to +70°C
Storage Temp: -25°C to +80°C
Relative Humidity: 95% non-condensing

Product Codes

516.052.051.Y (Vol 01B-04-D11)
MD601EX Conventional Rate of Rise Heat Detector
516.052.041.Y (Vol 01B-04-D11)
MD611EX Conventional Fixed Temperature Heat Detector

Flame Detectors



Flame detectors, unlike smoke and heat detectors, do not rely on convection to transport the fire products to the detector nor do they rely on a ceiling to trap the products. They can therefore be used to protect large open areas without sacrificing speed of response to flaming fires. In order to ensure full coverage however, flame detectors do require direct line of sight to all parts of the protected area. Infra-red flame detectors such as the 601FEX are designed to respond rapidly to fires which involve

clean-burning fuels such as alcohol or methane, i.e. fires which would not be detected by smoke detectors. The 601FEX Flame Sensor, by virtue of its operating wavelength and flicker discrimination is insensitive to normal environmental influences. For outdoor use a solar-blind detector [e.g. the S200 Plus] should be used. The 601FEX Flame detector should, normally, only be used inside buildings to supplement heat and smoke detectors.

ATEX Code: Ex II 1GD
Cenelec Code: Ex ia IIC T4/
Ex iaD 20
T135°C
Operating Temp Range: -20°C to +70°C
Storage Temp: -40°C to +80°C
Relative Humidity: 90% non-condensing

Product Codes

516.600.066 (Vol 01C-02-D10)
601FEX Infra-Red Flame Detector
516.600.067 (Vol 01C-02-D10)
601FEX-M Infra-Red Flame Detector (Marine)

Enhanced Carbon Monoxide Fire & Heat Detector



The MDU601EX detector is a combined CO and Rate of Rise Heat Detector where the sensitivity of the CO detector is enhanced in response to a fast rate of change of temperature.

ATEX Code: Ex II 1GD

Cenelec Code: Ex ia IIC T5/
Ex iaD 20
T100°C
Operating Temp Range: -10°C to +55°C
Storage Temp: -20°C to +55°C
Relative Humidity: 90% non-condensing

Product Code

516.061.001.Y (Vol 01B-04-D14)
MDU 601EX Enhanced Carbon Monoxide Fire & Heat Detector

5BEX Detector Base and Ancillaries



ATEX Code: Ex II 1GD
Cenelec Code: Ex ia IIC T5/
Ex iaD 20
T100°C
Operating Temp Range: -25°C to +70°C
Storage Temp: -40°C to +80°C
Relative Humidity: 95% non-condensing

Product Codes

517.050.023
5BEX 5" Universal Ex Base
517.050.603
DHM-5B deckhead mounting
517.001.120
System 601 EOL Unit (Pk 10)



Features

- Intrinsically Safe
- Weatherproof to IP67
- Compatible with System 620

Intrinsically Safe Callpoint - ATEX Approved

The MCP220Ex is a conventional callpoint for use on the ATEX Certified System.

Technical Specification

Dimensions:	93H x 98W x 66Dmm
Weight:	270g
Material:	PC/ABS
Colour:	Red
ATEX Code:	Ex II 1GD
Cenelec Code:	EX ia IIC T4 Ga /EX iaD T135°C Da
ATEX Cert:	SIRA 06ATEX2131X
IP Rating:	IP67

Product Code

514.001.109	MCP220Ex Red Callpoint intrinsically safe for use with ATEX certified conventional system 620.
-------------	--



Features

- Intrinsically safe
- Weatherproof to IP66/IP67
- Robust GRP Housing

BG3 Intrinsically Safe Conventional Callpoint -Atex Approved

This manual fire alarm call point is designed in accordance with the latest European Callpoint Standard (EN54-11).

Units are supplied in self coloured GRP with a 'Burning House' duty label as standard.

Weatherproof to IP66/IP67 and available certified intrinsically safe, simple apparatus manufactured from glass reinforced polyester (GRP) which provides a robust, corrosion free construction and ensures effective and reliable operation in harsh industrial and offshore environments.

Technical Specification

Model:	BG3I
Protection:	Explosion Protected EExia (Intrinsically Safe)
Certification:	CENELEC EN50014, 020 BASEEFA EExia IIC T4 Cert No. BAS00ATEX1067X Suitable for use in Zones 0,1 & 2
Voltage:	Up to 28V (IS)
Certified Temp:	-55°C to +55°C
Ingress Protection:	IP66 & IP67

European Standard

for Callpoints:	EN54-11
Terminals:	6 X 4.0mm2
Cable Entries:	2 X M20 Bottom
Weight:	0.5Kg
Material:	UV resistant glass reinforced polyester
Finish:	Natural Red GRP

Product Code

514.001.059	Intrinsically Safe Callpoint (BG3I4NBN)
-------------	---

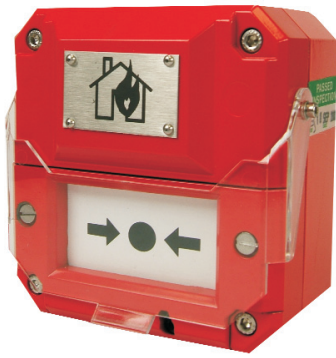

Features

- Polyester Enclosure – light, strong and not subject to corrosion.
- Break Glass.
- Explosion protected EExe (ATEX Approved).
- In line and end of line resistors.
- Red.
- 9 x terminals.
- Lift flap for extra protection against inadvertent operation.
- 1 x changeover switch.
- Captive cover screws.
- No hammer required – the glass is covered by a membrane thus protecting the operator from glass fragments.
- Key operated test facility – simple but secure.
- 2 x M20 bottom cable entries.

BG Conventional Callpoint EX II 2 GD

This EX II 2 GD Dust Approved & Increased Safety (EExemd) Conventional Break Glass Manual Alarm Call Point is fitted with a 470 ohm Alarm Level Resistor and a 4K7 ohm EOL Resistor for use with Tyco Conventional Detection Circuits including the DIM800 and DDM800 MX Modules.

It is also fitted with a removable link which allows it to be connected on its own or with other Conventional Devices to a Tyco Conventional Detection Circuit.

Technical Specification

Protection:	Explosion Protected EExed (Increased Safety)
Certification:	ATEX approved Ex II 2 GD BAS02ATEX2105X EExedmICT4 CENELEC EN50014 EN50019 EN50018 EN50028 Suitable for use in Zones 1 & 2
Voltage:	Up to 250V
Certified Temperature:	-20°C to +50°C
Ingress Protection:	IP66 & 67
Terminals:	9 x 2.5mm – up to 60V
Switch Ratings(1 x Changeover):	DC 0-30V 5A (Resistive) or 3A (Inductive) 30-50 1A Resistive or Inductive AC 0-254V 5A Resistive or Inductive
Cable Entries:	2 x M20 Bottom
Weight:	1.2Kg
Material:	Anti Static U.V. Resistant Glass Reinforced Polyester
Finish:	Red Epoxy Paint
Resistors:	Alarm: 470 Ohm EOL: 4K7 Ohm
Labelling:	Burning House Symbol

Product Code

514.001.108	EX II 2 GD Dust Approved & Increased Safety (EExemd) Conventional Break Glass Manual Alarm Callpoint
-------------	--



IS28 Mark 5 Banshee Electronic Sounder

The IS28 Mark 5 Banshee Electronic Sounder is the industry standard intrinsically safe sounder for use in hazardous gas and dust environments. This traditional high profile Banshee Electronic Sounder has 32 tones providing ultimate flexibility and is designed to be connected directly to the 24Vdc sounder circuit of a conventional Fire Alarm Control Panel via an MTL5525 Safety Barrier.

Please Note:-

1.The IS28 Mark 5 Banshee Electronic Sounder must only be used with the MTL5525 Sounder Driver (517.001.304) and not be connected to any other type of Sounder Driver (barrier) new or existing on the system.

2.Nothing else must be connected to the MTL5525 except IS28 Mark 5 Banshee Electronic Sounders (maximum of 3 per barrier, irrespective of the selected tone).

Technical Specification

- Intrinsically Safe for use in hazardous gas and dust environments
- ATEX Approved: Ex II 1GD (Certificate Number ITS10ATEX27151X)
- IECEX Approved: Certificate Number IECEX ITS 10.0050X
- Gas Code: Ex ia IIC T5
- Dust Code: Ex ia IIIC T100°C
- Ingress Protection to IP66
- Choice of 32 Selectable Tones
- Choice of 3 Volume Settings
- 2 x 20mm Cable Entry Knockouts

Product Code

576.501.017 IS28 Mark 5 Banshee Sounder



Features

- Robust GRP Body
- Suitable for offshore and petrochem
- Certificated Intrinsically Safe

XB8 Intrinsically Safe Beacon

This ruggedised, intrinsically safe and weatherproof beacon is intended for use in potentially explosive atmospheres, and has been designed with high ingress protection to cope with the harsh environmental conditions found offshore and onshore in the oil, gas and petrochemical industries.

Please refer to MEDC for guidance on cable capacitance and barriers.

Technical Specification

Certification:	CENELEC EN50014, 20 & 39 BAS02ATEX1258X EExia IIB T4 Zones 0,1 & 2
Material:	UV stable glass reinforced polyester body. Clear polycarbonate cover/lens. Retained stainless steel cover screws.
Finish:	Painted Red
Tube Type:	Xenon discharge
Lens Colour:	Clear
Terminals:	8 x 2.5mm ²
Flash Rate:	1 flash per second
Cable Entries:	Up to 3 x M20 via knockouts
Tube Energy:	0.5 Joules
Weight:	1.4kg
Certified Temperature:	-55°C to + 60°C
Ingress Protection:	IP66 & IP67
Tube Life:	>1 x 10 ⁶ Flashes
Voltage:	24V via suitable barrier
Current Consumption:	71mA max nominal

Product Code

540.001.038 Intrinsically Safe Xenon Beacon
(XB8BB024CNR)



Features

- For use in hazardous areas
- Robust GRP construction
- Powerful Output, up to 118dBA

DB3 Flameproof Horn Sounder

This lightweight all GRP flameproof sounder is intended for use in potentially explosive gas and dust atmospheres and has been designed with high ingress protection to cope with the harsh environmental conditions found offshore and onshore in the oil, gas and petrochemical industries.

The flamepaths, flare and body, are manufactured completely from a UV stable glass reinforced polyester. Stainless steel screws and sinter are incorporated thus ensuring a corrosion free product. A tapered flamepath is used to overcome the problems of assembly of parallel spigot flamepaths.

Technical Specification

Terminals:	6 x 2.5mm ²
Mounting:	Stainless steel bracket with ratchet facility
Cable Entries:	2 x 20mm EExd.
Tone Selection:	27 user selectable tones.
Certification:	CENELEC EN50014,18,19 BASEEFA Cert. No. BAS00ATEX2097X, EExd IIC. Zones 1 and 2.
Material:	Body & horn in anti-static, UV stable, glass reinforced polyester. Swivel bracket & captive cover screws in stainless steel.

*Output measured with 24VDC input voltage. Tone set to 970Hz continuous.

Weight:	6.0kg approx
Ingress Protection:	IP66 / IP67
Voltage:	12VDC to 48VDC
Certified Temperature:	-20° C to +70° C

Nominal Output (dBA)	Input Current (mA)*
93	50
105	100
108	150
111	200
112	250
114	300
115	350
118	380

Product Code

576.501.049 Flameproof Horn Sounder
(DB3D048N2BNR)



Features

- Robust Corrosion Resistant GRP body
- High Power (5 Joule)
- Certificated Flameproof

XB11 Flameproof Xenon Beacon

These certified beacons have been designed for use in potentially explosive gas and dust atmospheres and harsh environmental conditions. The glass reinforced polyester enclosures are suitable for use offshore or onshore, where light weight combined with corrosion resistance is required.

The beacon housing is manufactured completely from a U.V. stable, glass reinforced polyester. Stainless steel screws and mounting bracket are incorporated ensuring a totally corrosion free product.

Technical Specification

Voltage:	24Vdc
Tube Energy:	5 Joules
Peak Current	
Consumption (mA):	320
Effective Intensity (Cd):	29
Peak Intensity (Cd):	22213
Power Consumption (Watts):	8
Note:	The Cd figures are for a clear lens @ 1Hz flash rate. For red lens multiple by 0.15
Weight:	2.5Kg
Certified Temperature:	EExd -55°C to + 70°C (T4) -55°C to + 55°C (T5) -55°C to + 40°C (T6)
Ingress Protection:	IP66 & IP67
Terminals:	6 x 2.5mm ²
Entries:	2 x 20mm ISO EExd.
Certification:	BASEEFA EExd IIB 135°C (-55 to AMB +70°C)T4 100°C (-55 to AMB + 55°C)T5 85°C (-55 to AMB + 40°C)T6 Cert. No. 99 ATEX 2195X. CENELEC EN50014 and EN50018
Material	Body: Glass reinforced polyester Lens: Glass Cover Screws + Backstrap: Stainless steel 316 Finish: Red

Product Code

540.001.039	Flameproof Xenon Beacon (XB11B02406RNBNNNR)
-------------	--

Intrinsically Safe Barriers - Atex Approved

The following section relates to a range of intrinsically safe barrier and isolator equipment for use with Tyco Fire Protection Products manufactured fire detection systems. It essentially encompasses the relevant MTL5500 and MTL7700 series barriers plus the associated housing options as an alternative to existing MTL700 series equipment.

On all issues of intrinsically safe system design, please refer to Manual 26A for guidance.

Galvanic Isolators - MTL5500



The MTL5561 is a two channel interface for use with conventional detectors located in hazardous areas. This galvanic isolator is CE marked, and replaces the MTL3043 barrier option. It is suitable for connecting loads in Zone 0, IIC, T4-T6 hazardous areas if suitably certified.

The MTL5525 Isolating Sounder Driver enables an intrinsically safe sounder located in the hazardous area, to be controlled from the safe area. The MTL5525 barrier is designed as a CE marked replacement for the existing MTL3021 barrier. It has one channel and is suitable for connecting loads in Zone 0, IIC, T4-T6 hazardous areas if suitably certified.

When designing new systems or upgrading existing MTL3000 series systems to MTL5500 series, please use the appropriate MTL "DX" series enclosure equipment (16.2mm pitch).

Product Codes

517.001.302
MTL5561 2 Channel Galvanic Isolator
517.001.304
MTL5525 I.S. Sounder Driver

Zener Barriers - MTL7700



The MTL7700 Series intrinsically safe shunt-diode safety barriers are innovative devices designed to provide exceptionally high packing densities, straightforward installation and simplified connection, commissioning and maintenance facilities. The MTL7700 Series include secondary replaceable fuses. These are useful where there is the possibility of faults occurring during commissioning, which would otherwise blow the barriers' internal safety fuses.

One secondary replaceable fuse for each barrier channel is provided and is lower in value than the safety related fuse. Fuses are packaged in small mouldings which can be latched in a disconnect position to break the safe and hazardous areas during commissioning, maintenance and fault finding, thus avoiding the need for additional disconnect terminals.

Please note that this barrier is a direct alternative for the MTL728+ barrier.

Product Code

517.001.301
MTL7728 + Zener Safety Barrier for conventional detection circuits designed in accordance with System 601

Zener Barriers - MTL700



The MTL700 series are 1 or 2 channel devices which pass the electrical signal from fire detectors to the control panel or from the control panel to the output device. The barriers limit the amount of energy to a level that cannot ignite explosive atmospheres. The over-voltage protection provided by a Shunt-Diode Safety Barrier is with reference to the safety barrier earth connection. It is therefore imperative that a HIGH INTEGRITY EARTH is used for this type of barrier (14.2mm pitch).

Product Codes

517.001.201
MTL728 Single Channel Zener Safety Barrier
517.001.202
MTL788 Dual Channel Zener Safety Barrier
546.004.005
Intrinsically safe sounder circuit interface module

Safety Enclosures

UC Series Enclosures



The UC series of enclosures provides a simple but effective means of mounting and protecting the MTL3000 series units, in safe areas. A standard lightweight enclosure with transparent lid, which can accommodate 4 units. The polycarbonate enclosure is impact resistant, flame retardant and dustproof to IP65.

Product Code

517.001.196

UC2 4 Way Barrier Housing

MT Series Enclosures

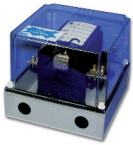

The MT series of enclosures provides a simple, effective means of mounting and protecting MTL700 Series barriers in safe areas or low-risk hazardous areas. Three lightweight polycarbonate enclosures with see through lids accommodate up to 2, 5 and 12 barriers in the safe area. All the enclosures are supplied ready fitted with a nickel plated brass busbar mount, so barriers can be installed and wired up immediately without special tools.

Product Codes

517.001.198

MT2 2 Way Zener Barrier Housing

517.001.199

MT5 5 Way Zener Barrier Housing

517.001.200

MT12 12 Way Zener Barrier Housing

Ancillaries

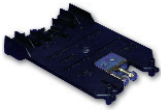

The ERL7 earth rail is a nickel plated 3 x 10mm rail (1 metre long), suitable for a do-it-yourself mounting arrangement. It will accommodate up to 2.5 ETM7 earth terminals per barrier location for terminating earth returns and cable screens from the hazardous area.

The IMB7 mounts on a flat surface or top hat rail (35mm) or G-profile rail and acts as a convenient method for mounting the earth busbar.

Product Codes

517.001.205

ERL7 Earth rail for I.S. systems

517.001.206

ETM7 Earth termination connection system

517.001.207

IMB7 Insulating mounting block



Features

- Continuous detection despite extremely large monitoring area.
- Easy and rapid installation of the maintenance free sensor cable.
- Very high resistance to extreme ambient influences (immune against heat, cold, humidity, corrosion, strong winds and draft).
- Undiminished operation under electromagnetic interference.
- Unprecedented security against false alarms.
- Very high sensor cable service life of up to 30 years.
- Temperature profile over the complete measurement range delivers exact information of location, size and spread of fire.
- Very low maintenance costs as maintenance and trouble shooting can be done from the control unit.
- VdS certified to EN 54 part 5
- One controller unit will drive up two 8 km spurs or one 8 km loop.
- Easy integration into existing installations.
- Each sensor cable divided into up to 256 zones.
- Individual configuration of 5 alarm criteria per zone.
- Network connection through Modbus, TCP/IP, FTP and SCPI interfaces.

MZX SensorLaser™ Plus Fibre Optic Linear Heat Detection System

The MZX SensorLaser™ Plus guarantees fast and continuous fire detection even in difficult and varying ambient conditions. This linear heat detection system enables long and heavily fragmented facilities such as traffic and supply tunnels, cable routes and conveyor belts as well as large scale buildings such as production halls, cold stores and multi storey car parks to be monitored at all times. The MZX SensorLaser™ Plus is ideal for use in areas that are hard or impossible to access after installation, e.g. false floors, since maintenance and troubleshooting can be carried out from the control unit.

The fibre optic sensor cable itself is maintenance free and, thanks to its particularly robust characteristics, offers a high level of security against false alarms. The sensor cable is insensitive to dust, dirt, moisture, high temperatures (up to approx. 90 °C), pressure and the action of vibration and wind as well as corrosive atmospheres. Because of its purely passive, optical analysis process, the MZX SensorLaser™ Plus is even immune from electromagnetic interference caused by generators, energy routes, cables or electric motors.

The MZX SensorLaser™ Plus delivers precise information about the location, size and spread of a fire even under ambient conditions that would cause other fire detection systems to fail.

The MZX SensorLaser™ Plus enables a measuring range of up to 8 km per sensor cable. Up to 2 spurs each with an 8 km measurement range, or 1 loop with an 8 km range can be connected. Since the ambient conditions in a monitoring area of this size can vary enormously, each sensor cable can be divided into up to 256 zones. Several alarm criteria can be freely defined in each zone. This level of precision adjustment allows the MZX SensorLaser™ Plus to provide a high level of resistance to false alarms and precise fire detection despite contrary and variable ambient conditions.

The accessible laser radiation emitted by the Class 1M laser is not hazardous to the eyes (provided there are no other optical instruments in the path of the beam), while operation is absolutely fail-safe even in the event of a break in the cable. In addition, the sensor cable can be used in explosive atmospheres (ATEX zones) up to zone 0 without any additional measures being required. In contrast to conventional fibre optic systems, the low laser output of < 20mW ensures that the measuring system has a long service life.

Zone Configuration

Ambient conditions (temperatures) can fluctuate sharply over a measuring range of many hundreds of metres. This makes it essential to divide the measuring range into zones that can be adapted optimally to the ambient conditions on the basis of differing alarm criteria. This ensures high detection reliability and also security against false alarms.

The MZX SensorLaser™ Plus allows the measuring range to be very finely divided into zones. Up to 256 zones can be defined for each sensor cable, with up to 5 alarm criteria configurable in each zone. Another 2 alarm criteria respond when there is a temperature drop, enabling them to be used e.g. in tunnels to warn of black ice.

Chapter 10 - Special Hazards

MZX SensorLaser™ Plus Fibre Optic Linear Heat Detection System Con't.

Control Unit

With ten product variants, permitting measuring ranges of 1 to 8 km, the MZX SensorLaser™ Plus can be configured to suit the particular project.

Sensor Cable

The sensor cables offered are optimised for a rapid response time. The sheathing is flame retardant, halogen free and resistant to dust, dirt, moisture, corrosive atmospheres and most organic solvents. Both types of sensor cable offer adequate protection against rodents and are designed for a service life of 30 years.

There are two different types of sensor cable for differing project requirements. The MZX SensorLaser™ Plus Safety cable can be used under normal ambient conditions. It is particularly flexible and extremely versatile.

Where the sensor cable is expected to be exposed to high mechanical stresses, we recommend that the MZX SensorLaser™ Plus Steel Wire Armoured cable be used. This sensor cable, which was specifically developed for heavy duty applications, is particularly suitable where high tensile forces and high lateral pressures can occur.

The cable length will be individually cut to the customer specified length and 2 connectors are fitted for easy handling. The cable should be commissioned in multiples of one metre and therefore the order for the cable has to be placed per metre.

Every order for sensor cable must include the corresponding connectors, which will be assembled by the supplier. The cable with pre assembled connectors offers fast commissioning of the system without any additional splicing.

Mounting Materials

For professional mounting of the sensor cables four different types of mounting sets are available. These sets are designed for different applications. They can be used for the mounting of the sensor cable to the wall and the ceiling. Every set contains 100 x clamps, 100 x anchors and 1 x SDS drill bit.

Plastic Clamps

The plastic of these clamps is UV resistant, halogen free and particularly robust in ambient conditions.

Steel Clamps

The clamps in these sets are made of stainless steel or zinc plated steel and are rubber protected. The rubber protection guarantees that the sensor cable is not damaged if friction occurs. For every clamp 2 x nuts are included for fixing to the anchor.

Connection Cable

Connection to the MZX Fire Alarm Panel is by means of the MZX SensorLaser™ Plus Connection Set. This set consists of 3 x cables. For connection of the Fire Alarm Panel to one end of the sensor cable a D-Sub connector is included. The other end of the sensor cable is desoldered which provides a quick connection into the MZX System without any soldering effort.

Enhanced Communication

The MZX SensorLaser™ Plus iBox allows the 20 relay outputs supplied as standard to be expanded up to 2 x 256 outputs so that each zone can be assigned its own relay output. This could, for instance, be used to control fire extinguishing systems. The iBox also enables connection to SCADA or process control systems via Modbus TCP or Modbus RTU.

The number of relays can be extended using the MZX SensorLaser™ Plus Relay Controller Set. This set consists of a pre-programmed field bus controller, one Digital Output Module and an End module. It also comes with 8 x relays and accessories for easy wiring.

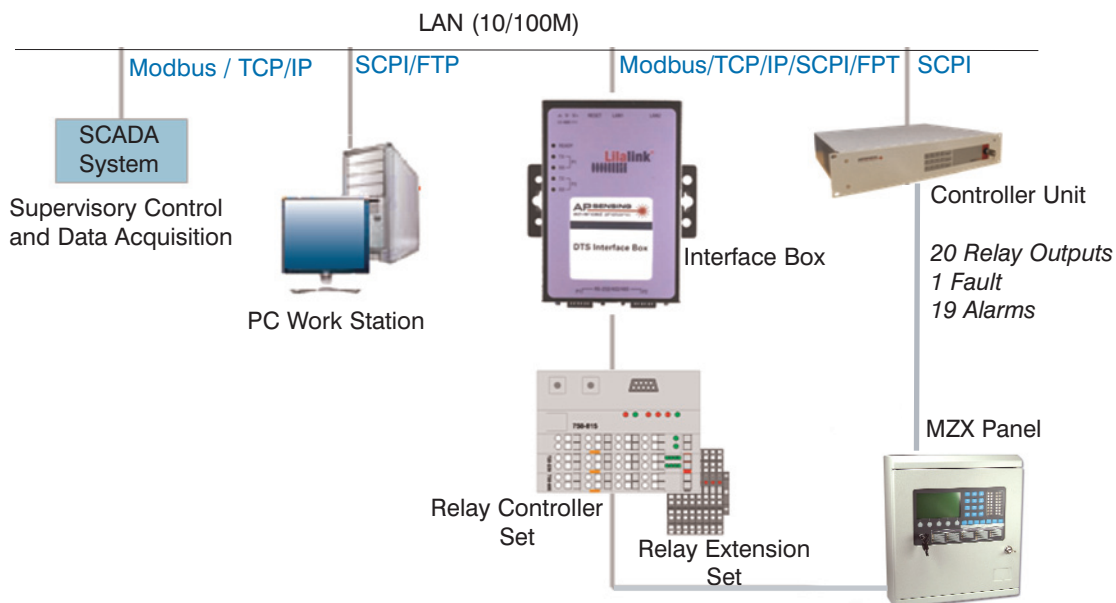

By means of the Relay Controller Set and the Relay Extension Set an additional 256 relays per sensor cable can be connected.

MZX SensorLaser™ Plus Fibre Optic Linear Heat Detection System Con't.

Complies with the essential requirements of the following applicable European Directives and carries the CE marking accordingly:

- The Low Voltage Directive 73/23/EEC amended by 93/68/EEC
- The EMC Directive 2004/108/EC

Conforms with the following product standards:

EMC

IEC61326:1997+A1:1998+A2:2000
 EN61326:1997+A1:1998+A2:2001
 CISPR11:1997+A1:1999 / EN55011:1998+A1:1999
 IEC61000-4-2:2001/EN61000-4-2:1995+A1:1998+A2:2001
 IEC61000-4-3:2002/EN61000-4-3:2002
 IEC61000-4-4:2001/EN61000-4-4:1995+A1:2001+A2:2001
 IEC61000-4-5:2001/EN61000-4-5:1995+A1:2001
 IEC61000-4-6:1995+A1:2000 /EN61000-4-6:1996+A1:2001
 IEC61000-4-8:2001/EN61000-4-8:1993+A1:2001
 IEC61000-4-11:1994+A1:2000
 EN61000-4-11:1994+A1:2001
 Canada: ICES-001:1998

Technical Specification

Operating temperature range:
 -10°C to +60°C (2 channel options: from -5°C)

Storage temperature range:
 -40°C to +80°C

Operating humidity range:
 0% to 95% RH (2 channel options: 15% to 85% RH) non condensing

Dimensions (H x W x D):
 88 x 448 x 364 mm (19" rack)

Weight:
 9 kg

Fibre types:
 MM 50/125 µm graded index MM
 62.5/125 µm graded index

Dynamic range:
 30 dB (2-way loss)

Sensing temperature range:
 -273°C to +700°C depending on sensor coating

Optical connector:
 E2000; 8° angled

Number of channels:
 1, 2 depending on channel option

Computer interface:
 USB, LAN

Relay board:
 4 inputs / 20 outputs

Power supply:
 10 V to 30 Vdc

Power consumption:
 15 W typically, at 20°C ambient temperature < 40 W (entire operating conditions)

Measurement times:
 from 10s to 30s

Available spatial resolution settings:
 1 m; 1.5 m; 3 m; 5 m; 8 m

Available measurement modes:
 Single ended/Dual ended; including fibre break recovery

Internal data storage capability:
 150 traces total

Power Supply (option) operating conditions:
 0°C to +50°C; non condensing; indoor use only

Laser class (IEC 60825-1: 2001):1M

SAFETY

IEC61010-1:2001/EN61010-1:2001
 IEC60825-1:2001/EN60825-1:1994+A11:1996+A2:2001
 Canada:CAN/CSA-C22.2No.61010-1:2004
 USA:UL61010-1:2004;FDA21CFR1040.10+Laser Notice No.50

Product Codes

516.016.310	MZX SensorLaser™ Plus 1/1 – 1 km range, 1 sensor cable.
516.016.311	MZX SensorLaser™ Plus 1/2 – 1 km range, 2 sensor cables.
516.016.312	MZX SensorLaser™ Plus 2/1 – 2 km range, 1 sensor cable.
516.016.313	MZX SensorLaser™ Plus 2/2 – 2 km range, 2 sensor cables.
516.016.333	MZX SensorLaser™ Plus 3/1 – 3 km range, 1 sensor cable.
516.016.334	MZX SensorLaser™ Plus 3/2 – 3 km range, 2 sensor cables.
516.016.314	MZX SensorLaser™ Plus 4/1 – 4 km range, 1 sensor cable.
516.016.315	MZX SensorLaser™ Plus 4/2 – 4 km range, 2 sensor cables.
516.016.316	MZX SensorLaser™ Plus 8/1 – 8 km range, 1 sensor cable.
516.016.317	MZX SensorLaser™ Plus 8/2 – 8 km range, 2 sensor cables.
516.016.318	MZX SensorLaser™ Plus Connection Set.
516.016.319	MZX SensorLaser™ Plus iBox
516.016.320	MZX SensorLaser™ Plus Relay Controller Set.
516.016.321	MZX SensorLaser™ Plus Power Supply.
516.016.322	MZX SensorLaser™ Plus Safety Cable (per metre).
516.016.322.C	MZX SensorLaser™ Plus Safety Connector.
516.016.323	MZX Steel Wire Armoured SensorLaser™ Plus Cable (per metre).
516.016.323.C	MZX SensorLaser™ Plus Steel Connector.
516.016.324	MZX SensorLaser™ Plus Setting Tool.
516.016.325	MZX SensorLaser™ Plus Relay Extension Set.
516.016.326	MZX SensorLaser™ Plus Zinc Plastic Clamp Set. (PK 100)
516.016.327	MZX SensorLaser™ Plus Steel Plastic Clamp Set. (PK 100)
516.016.328	MZX SensorLaser™ Plus Steel Zinc Clamp Set. (PK 100)
516.016.329	MZX SensorLaser™ Plus Stainless Steel Clamp Set. (PK 100)
516.016.330	MZX SensorLaser™ Plus Spare Unit.
516.016.331	MZX SensorLaser™ Plus Demo Unit.
516.016.332	MZX SensorLaser™ Plus Demo Box.

This page is left intentionally blank.

MKII Sounder Base Application Table

PART NO.	DESCRIPTION	CONTROL PANEL COMPATIBILITY	POWERED FROM	DETECTOR REQUIRED TO OPERATE	PARK CLIP COLOUR
577.001.035	601SB CONVENTIONAL SOUNDER BASE	CONVENTIONAL ONLY	24Vdc	NO	GREEN
577.001.037	601SBD CONVENTIONAL DIODE SOUNDER BASE	CONVENTIONAL ONLY	24Vdc	NO	GREEN
516.800.911	901SB UNIVERSAL SOUNDER BASE	MINERVA ADDRESSABLE/MX	24Vdc	YES	BLUE
516.800.912	912SB UNIVERSAL UL SOUNDER BASE	MINERVA ADDRESSABLE/MX	24Vdc	YES	BLUE
577.001.036	602SB 2 WIRE LINE POWERED SOUNDER BASE	MZX-c ONLY	DETECTION CIRCUIT	NO	YELLOW
577.001.038	602SBD 2 WIRE LINE POWERED DIODE SOUNDER BASE	MZX-c ONLY	DETECTION CIRCUIT	NO	YELLOW
516.800.910	802SB MX LOW POWERED SOUNDER BASE	MX ONLY	LOOP	YES	WHITE
516.800.913	812SB LOOP POWERED UL SOUNDER BASE	MX ONLY	LOOP	YES	WHITE

PART NO.	DESCRIPTION	CURRENT CONSUMPTION AT 68 dBA (MINIMUM VOLUME)	CURRENT CONSUMPTION AT 90 dBA (MAXIMUM VOLUME)	CURRENT CONSUMPTION AT 100dBA (FIXED VOLUME)
577.001.035	601SB CONVENTIONAL SOUNDER BASE	1.2mA	6.8mA	
577.001.037	601SBD CONVENTIONAL DIODE SOUNDER BASE	1.2mA	6.8mA	
516.800.911	901SB UNIVERSAL SOUNDER BASE	1.2mA	6.8mA	21mA
516.800.912	912SB UNIVERSAL UL SOUNDER BASE	1.2mA	6.8mA	
577.001.036	602SB 2 WIRE LINE POWERED SOUNDER BASE	1.2mA	6.8mA	
577.001.038	602SBD 2 WIRE LINE POWERED DIODE SOUNDER BASE	1.2mA	6.8mA	
516.800.910	802SB MX LOW POWERED SOUNDER BASE	1.2mA	6.8mA	
516.800.913	812SB LOOP POWERED UL SOUNDER BASE	1.2mA	6.8mA	21mA

MKII Sounder Base Application Table

PART NO.	DESCRIPTION	FAST SWEEP (2)	TEMPORAL 3 ALTERNATING 2(11)	ALTERNATING 2 (9)	CONTINUOUS(14)	CONTINUOUS
577.001.035	601SB CONVENTIONAL SOUNDER BASE	YES	YES	YES	YES	
577.001.037	601SBD CONVENTIONAL DIODE SOUNDER BASE	YES	YES	YES	YES	
516.800.911	901SB UNIVERSAL SOUNDER BASE	YES	YES	YES	YES	
516.800.912	912SB UNIVERSAL UL SOUNDER BASE	YES	YES	YES	YES	YES
577.001.036	602SB 2 WIRE LINE POWERED SOUNDER BASE	YES	YES	YES	YES	
577.001.038	602SBD 2 WIRE LINE POWERED DIODE SOUNDER BASE	YES	YES	YES	YES	
516.800.910	802SB MX LOW POWERED SOUNDER BASE	YES	YES	YES	YES	
516.800.913	812SB LOOP POWERED UL SOUNDER BASE	YES	YES	YES	YES	YES

PART NO.	DESCRIPTION	DUTCH SLOW SWEEP (7)	TEMPORAL 4 SLOW SWEEP (3)	MARCH TIME BEEP(25)	MARCH TIME BEEP(26)
577.001.035	601SB CONVENTIONAL SOUNDER BASE	YES	YES	YES	YES
577.001.037	601SBD CONVENTIONAL DIODE SOUNDER BASE	YES	YES	YES	YES
516.800.911	901SB UNIVERSAL SOUNDER BASE	YES	YES	YES	YES
516.800.912	912SB UNIVERSAL UL SOUNDER BASE	YES	YES	YES	YES
577.001.036	602SB 2 WIRE LINE POWERED SOUNDER BASE	YES	YES	YES	YES
577.001.038	602SBD 2 WIRE LINE POWERED DIODE SOUNDER BASE	YES	YES	YES	YES
516.800.910	802SB MX LOW POWERED SOUNDER BASE	YES	YES	YES	YES
516.800.913	812SB LOOP POWERED UL SOUNDER BASE	YES	YES	YES	YES

(2) (3) (7) (9) (11) (14) (25) (26) = ROSHNI TONE NUMBER

Banshee Excel Tone Table

Tone Information		Description	Frequency and Timing	Banshee Excel™ (12V)		Banshee Excel™ (24V)		Banshee Excel Lite™ (24V)	
No	DIL SW 12345			dBA	mA	dBA	mA	dBA	mA
			2nd Tone						
1	00000	Banshee Buzz LF	800Hz to 950Hz swept at 120Hz	94	6	101	12	94	6
2	10000	Banshee Fast Sweep LF*	800Hz to 950Hz swept at 9Hz	94	6	101	12	94	6
3	01000	Banshee Slow Sweep LF	800Hz to 950Hz swept at 3Hz	94	6	101	12	94	6
4	11000	Banshee Continuous LF	Continuous at 900Hz	94	6	101	12	94	6
5	00100	Banshee Fast Sweep LF (New)	830Hz to 970Hz swept at 9Hz	95	6	101	12	93	6
6	10100	Medium Sweep LF*	800Hz to 950Hz swept at 1Hz	96	6	101	12	94	6
7	01100	Continuous LF	Continuous at 950Hz	96	6	102	13	94	6
8	11100	Back up Alarm LF	Intermittent at 950Hz 1 sec on, 1 sec off	96	8	102	14	93	6
9	00010	Alternate LF	Alternating 800Hz/1000Hz at 1Hz	94	6	100	13	94	6
10	10010	Medium Sweep LF	800Hz to 1000Hz swept at 0.5 secs	95	6	101	12	94	6
11	01010	Alternate LF	Alternating Tones 800/950 at 3Hz	96	6	101	12	94	6
12	11010	Banshee Buzz HF	2400Hz to 2900Hz at 120Hz	102	16	110	35	102	16
13	00110	Banshee Fast Sweep HF	2400Hz to 2900Hz at 9Hz	103	17	110	35	103	17
14	10110	Banshee Slow Sweep HF	2400Hz to 2900Hz at 3Hz	103	17	110	35	103	17
15	01110	Banshee Continuous HF	Continuous 2900Hz*	103	19	110	39	103	19
16	11110	Banshee Fast Sweep HF (New)	2450Hz to 3100Hz swept at 9Hz	103	18	110	36	103	18
17	00001	Back up Alarm HF	Intermittent at 2900Hz 1 sec on, 1 sec off	104	18	110	36	103	18
18	10001	Alternate HF	Alternating Tones 2400/2900 at 3Hz	104	16	110	36	104	17
19	01001	Slow Whoop*	500Hz rising to 1200Hz over 3.5 sec, silence 0.5 sec	95	6	101	12	95	6
20	11001	Din Tone (DK)*	1200Hz falling to 500Hz over 1 sec, silence 10mS, repeat	93	5	100	10	93	5
21	00101	French Fire Sound*	554Hz for 100mS and 440Hz for 400mS	90	4	96	7	90	4
22	10101	Australian Alert Signal	420Hz repeating 0.625 sec on, 0.625 sec off	89	3	95	6	89	3
23	01101	Australian Evacuation Signal	500Hz to 1200Hz sweeping, 3.75 secs on, 0.25 secs off	95	6	103	12	95	6
24	11101	US Temporal Tone LF	950Hz for 0.5 sec on. 0.5 sec off for 3 phases, silence for 1.5secs and repeat	95	5	101	10	93	5
25	00011	US Temporal Tone HF	2900Hz for 0.5 sec on. 0.5 sec off for 3 phases, silence for 1.5secs and repeat	104	13	110	26	103	13
26	10011	Swedish Tone (Fire)	Intermittent 660Hz 150mS on, 150mS off	90	3	96	6	90	3
27	01011	Swedish Tone (All Clear)	Continuous 660Hz	91	5	97	9	91	5
28	11011	ISO8201 LF	Intermittent 970Hz 500mS on, 500mS off	93	5	99	10	90	5
29	00111	ISO8201 HF	Intermittent 2900Hz 500mS on, 500mS off*	103	13	110	27	103	13
30	10111	BT Banshee (FP1063.1)	Yodel 800Hz/1000Hz, 0.25sec each frequency	93	6	100	12	94	6
31	01111	BT Banshee (FP1063.1)	Continuous 1000Hz	90	6	96	14	88	6
32	11111	Bell Tone	Bell Tone	96	12	101	25	94	12

Notes: *Tones highlighted in bold are approved under the Construction Product Directive. Sound output (dBA) and current (mA) values are typical.

Chapter 11 - Useful Information

Fulleon Sounder Tone Compatibility Table

Fulleon Tone	Tone Number	2 Wire Symphoni	24V Symphoni	Sounder Base 601SB/601SBD 602SB/602SBD
		SWITCH A B	SWITCH 1 2 3 4 5	SWITCH 1 2 3 4
CONTINUOUS TONE (970HZ)	14	1 0	10010	111X (880Hz)
PULSED/INTERMITTENT TONE (970HZ@ 1HZ)	25	1 1	00111	011X (880Hz@1Hz)EURO ONLY
ALTERNATING TONE (970HZ/800HZ@2HZ) (CLOSEST MATCH)	1	0 1 (990HZ/650HZ@2HZ)	11111	N/A
DUTCH SLOW WHOOP (500Hz-1200Hz-3s on/0.5s off)	7	N/A	11001	000X
SLOW SWEEP (800Hz/970Hz@1Hz)	3	N/A	11101	010X
FAST SWEEP (800Hz/970Hz@7HZ)	2	N/A	11110	100X
TWO TONE/ALTERNATING (800HZ/970HZ@1HZ)	11	N/A	10101	110X (660Hz/880Hz@1Hz)EURO ONLY

Fulleon Sounder Tone Table

No.	STONE
1	ALT TONES 800/970 at 1/4 Hz
2	SWEEPING 800/970Hz at 7Hz
3	SWEEPING 800/970Hz at 1Hz
4	CONTINUOUS at 2850Hz
5	SWEEPING 2400-2850Hz at 7Hz
6	SWEEPING 2400-2850Hz at 1Hz
7	SLOW WHOOP
8	SWEEP 1200-500 at 1Hz
9	ALT TONES 2400/2850 2Hz
10	INT TONE OF 970Hz at 1Hz
11	ALT TONES 800/970 Hz at 1Hz
12	INT TONE at 2850 Hz at 1Hz
13	970Hz at 1/4 SEC. ON 1 SEC. OFF
14	CONTINUOUS AT 970Hz
15	554 FOR 100ms and 440Hz FOR 400ms
16	INT 660Hz 150ms ON/150ms OFF
17	INT 660Hz 1.8s ON/1.8s OFF
18	INT 660Hz 6.5s ON/13s OFF
19	CONTINUOUS 660Hz
20	ALT 554/440Hz at 1Hz
21	INT 660Hz 1Hz
22	INT 2850Hz 150ms ON 100ms OFF
23	SWEEP 800-970Hz at 50Hz
24	SWEEP 2400-2850Z at 50 Hz
25	INTERMITTENT 970Hz 500ms ON 500ms OFF
26	INTERMITTENT 2850HZ 500ms ON 500ms OFF
27	CONTINUOUS AT 4kHz
28	ALTERNATING TONES 800/970 AT 2Hz
29	ALTERNATING TONES 988/645 AT 2Hz
30	ALTERNATING 510/610 at 1Hz
31	SWEEPING 300-1200 at 1Hz
32	CONTINUOUS AT 4kHz

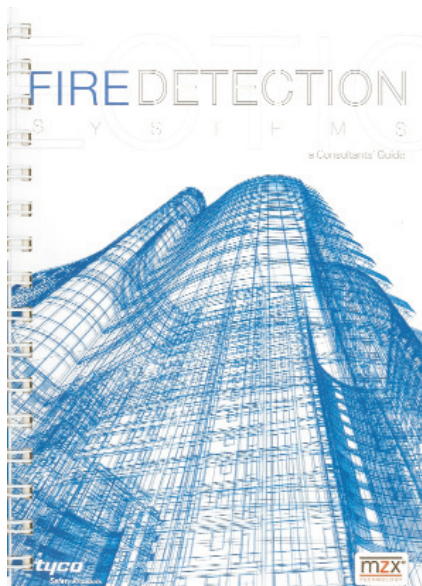

Consultants Guide

A Fire Detection System Consultants Guide for consultants designing systems to BS5839-1:2002.

Features

- Selecting the category of protection and coverage.
- How to configure detector zones and alarm zones within premises.
- Which type of fire detection system?
- Detector suitability.
- Detector coverage.
- Manual break glass call points.
- Limitation of false alarms.
- Means of giving warning to occupants.
- Control and indicating equipment.
- Power supplies.
- Cabling considerations.
- Communication with the fire service.
- System installation.
- Documentation.
- Standards and Specifications.
- Associated Ancillary Equipment.
- Networking and Graphics.
- Installation.
- Commissioning.
- Training.
- Maintenance.

Product Code

CGUK-01 Consultants Guide

This page is left intentionally blank.

Index

Product Code	Description	Chapter	Page
542.098	MZX4000 Black Box	2	8
572.065	MX Rack Mounting Kit for standard 19" racks	2	6
2000636	MZX-c+ CONVENTIONAL PANEL TRANSFORMER 1.5 AMP	3	48
2000637	MZX-c+ CONVENTIONAL PANEL TRANSFORMER 3.0 AMP	3	48
2000638	MZX-c+ CONVENTIONAL PANEL TRANSFORMER 5.0 AMP	3	48
2501061	MZX-c CONVENTIONAL PANEL SPARE ENABLE KEY	3	48
2572200	CeITEL 4 Way Master EVC Panel with Handset and Display	8	4
2572201	CeITEL 8 Way Master EVC Panel with Handset and Display	8	4
2572202	CeITEL Master Controller without Handset	8	4
2572203	CeITEL Slave EVC Panel with 8 Additional Lines	8	4
2572204	CeITEL EVC Network Communication Card	8	4
2572206	Anti Tamper Enclosure for the CeITEL Master EVC Panel	8	4
2572210	Type B Stainless Steel Flush Mounting Disabled Refuge Outstation	8	4
2572211	Type B Stainless Steel Surface Mnt Disabled Refuge Outstation	8	4
2572212	IP65 Enclosure for Type B Surface Mnt Disabled Refuge Outstation	8	4
2572213	Type A Fire Telephone Outstation with Push Door	8	4
2572214	Type A Fire Telephone Outstation with Lift up Lock	8	4
2572215	Type B Green Flush Mounting Disabled Refuge Outstation	8	4
2572216	Type B Green Surface Mounting Disabled Refuge Outstation	8	4
2572217	Semi Flush Bezel for Type A Outstation	8	4
2572219	Disabled Persons Toilet Alarm	8	4
2605060	C1630 O/P Expansion Interface Board	3	4
2605060	C1630 O/P Expansion Interface Board	3	6
2605060	C1630 O/P Expansion Interface Board	3	48
2605061	C1631 Repeater Interface Board	3	4
2605061	C1631 Repeater Interface Board	3	4
2605061	C1631 Repeater Interface Board	3	6
2605062	C1632 16 Zone Interface Board	3	4
2605063	C1633 LED Driver Board	3	4
2605063	C1633 LED Driver Board	3	6
2605064	C1634 Relay Output Board	3	4
2605064	C1634 Relay Output Board	3	6
2605065	C1635 Monitored Output Board	3	4
2605065	C1635 Monitored Output Board	3	6
2605070	C1651 MZX-c+ Timer Board	3	4
2605071	MZX-c+ CONVENTIONAL PANEL 5.0 AMP PSU - C1652	3	48
2605505	MZX-c MOTHERBOARD 8 ZONE REPEATER	3	48
2605508	MZX-c 2 ZONE 2 WIRE MZX-c MOTHERBOARD	3	48
2605509	MZX-c 4 ZONE 2 WIRE MZX-c MOTHERBOARD	3	48
2605510	MZX-c 8 ZONE 2 WIRE MZX-c MOTHERBOARD	3	48
2605538	MZX-c CONVENTIONAL PANEL ZONE EOL UNIT - PK5	3	48
10-115	SR2-T Optional Back Box (2 terminals)	2	53
10-115	SR2-T Optional Back Box (2 terminals)	3	27
20-100	6" 24Vdc Electronic bell, weatherproof IP33C - Wormald Branded	2	61
20-100	6" 24Vdc Electronic bell, weatherproof IP33C - Wormald Branded	3	33
20-101	6" 24Vdc Electronic bell - red IP21C - Wormald Branded	2	61
20-101	6" 24Vdc Electronic bell - red IP21C - Wormald Branded	3	33
20-111	6" 24Vdc Electronic bell - white IP21C	2	61
20-111	6" 24Vdc Electronic bell - white IP21C	3	33
20-112	Xenon Beacon Low profile red 24Vdc 2 watt	2	71
20-112	Xenon Beacon Low profile red 24Vdc 2 watt	3	44
20-113	Xenon Beacon Low profile red 24Vdc 5 watt	2	71
20-113	Xenon Beacon Low profile red 24Vdc 5 watt	3	44
20-118	Flashni complete with deep base (IP65)	2	72
20-118	Flashni complete with deep base (IP65)	3	45
20-120	Xenon Beacon Low profile red 24Vdc 3 watt	2	71
20-120	Xenon Beacon Low profile red 24Vdc 3 watt	3	44
22-5049-10M	WebWay High Gain Eng Pack with 10 metres of Cable	2	23
22-5049-15M	WebWay High Gain Eng Pack with 15 metres of Cable	2	23
22-5054	WebWay Smart Disc Eng Pack	2	23
2-34-035G-S001	Door release magnet set, floor mount, ABS housing 24VDC	6	3
3000-201	FireRay 3000 Swivel Bracket	2	33
3000-201	FireRay 3000 Swivel Bracket	3	17

Chapter 12 - Index

Product Code	Description	Chapter	Page
3-59-0404-S001	Door release magnet set, Wall Mount, Metal Housing, 230VAC	6	3
3-59-0404-S002	Door release magnet set, Wall Mount, Metal Housing, 24VDC	6	3
3-84-0301	Floor mounting bracket for wall mounted door magnets	6	3
3-87-0351	Door release magnet set, Wall Mount, ABS Housing, 24VDC	6	3
3-87-0352	Door magnet Wall Mnt ABS 230V	6	3
5000-005	Universal Mounting Bracket	2	33
5000-005	Universal Mounting Bracket	3	17
5000-006	Flat Mounting Plate for 1 to 4 Prisms	2	33
5000-006	Flat Mounting Plate for 1 to 4 Prisms	3	17
5000-007	Prism Mounting Plate for 4 Prisms	2	33
5000-007	Prism Mounting Plate for 4 Prisms	3	17
5000-008	Prism Mounting Plate for 1 Prism	2	33
5000-008	Prism Mounting Plate for 1 Prism	3	17
508.020.026	TXG Emergency Management PC (no monitor)	4	2
508.020.050	19" LCD Touchscreen Monitor	4	2
508.023.001	T1204DC 4 ZONE PANEL C/W 1.5A 24VDC PSU	3	6
508.023.002	T1204A1 4 ZONE PANEL C/W 1.5A 110VAC PSU	3	6
508.023.003	T1204A2 4 ZONE PANEL C/W 1.5A 230VAC PSU	3	6
508.023.004	T1216 16 ZONE PANEL C/W VOYAGE DATA O/P	3	6
508.023.005	T1216W 16 ZONE WATER MIST FIRE DETECTION PANEL	3	6
508.023.006	T1232 32 ZONE PANEL C/W VOYAGE DATA O/P	3	6
508.023.011	T1216RDC 16 ZONE REPEATER WITHOUT PSU	3	6
508.023.013	T1216RA2 16 ZONE REPEATER C/W 1.5A 230VAC PSU	3	6
508.023.014	T1232RDC 32 ZONE REPEATER WITHOUT PSU	3	6
508.023.016	T1232RA2 32 ZONE REPEATER C/W 1.5A 230VAC PSU	3	6
508.023.021	T1200EA EXPANSION BOX C/W 5.0A 110/230VAC PSU	3	6
508.023.022	T1200EDC EXPANSION BOX (NO PSU)	3	6
508.023.023	T1200B BATTERY BOX FOR T1204 4 ZONE PANEL	3	6
508.023.025	T1200 RMRS DOOR STAY KIT	3	6
508.023.035	C1665 MUSTER INTERFACE BOARD	3	6
508.023.036	A1466 RELAY OUTPUT BOARD	3	6
508.023.051	T1216 ENGLISH/CHINESE/JAPANESE INSERT SET	3	6
508.023.052	T1232 ENGLISH/CHINESE/JAPANESE INSERT SET	3	6
508.023.053	T1216R ENGLISH/CHINESE/JAPANESE INSERT SET	3	6
508.023.054	T1232R ENGLISH/CHINESE/JAPANESE INSERT SET	3	6
508.023.126	AC2SW 230VAC Changeover Unit	2	9
508.023.126	AC2SW 230VAC Changeover Unit	2	10
508.023.127	AC1SW 115VAC Changeover Unit	2	9
508.023.127	AC1SW 115VAC Changeover Unit	2	10
508.031.004.EG	MZX-c 2 ZONE PANEL TYCO 2 WIRE	3	2
508.031.005.EG	MZX-c 4 ZONE PANEL TYCO 2 WIRE	3	2
508.031.006.EG	MZX-c 8 ZONE PANEL TYCO 2 WIRE	3	2
508.031.016.EG	MZX-c 8 ZONE REPEATER PANEL	3	2
508.032.002.EA	MZXC+ 4 Zone Panel English/Arabic	3	4
508.032.003.EA	MZXC+ 8 Zone Panel English/Arabic	3	4
508.032.004.EA	MZXC+ 16 Zone Panel English/Arabic	3	4
508.032.005.EA	MZXC+ 32 Zone Panel English/Arabic	3	4
508.032.006.EA	MZXC+ 8 Zone Repeater 240Vac English/Arabic	3	4
508.032.007.EA	MZXC+16 Zone Repeater 240Vac English/Arabic	3	4
508.032.008.EA	MZXC+ 32 Zone Repeater 240Vac English/Arabic	3	4
508.032.012	MZXC+ 4 Way Expansion Housing	3	4
508.032.013	MZXC+ 4 Way Expansion Housing with PSU	3	4
508.032.014	MZXC+ 5 Way Expansion Housing	3	4
508.032.015	MZXC+ 5 Way Expansion Housing with PSU	3	4
508.033.002.EA	MZX-e SLU1 Status Lamp Unit, Indication only English / Arabic	3	7
508.033.003.EA	MZX-e SLU2 Status Lamp Unit, Indication, English / Arabic	3	7
508.033.004.EA	MZX-e SLU3 Full Function Status Lamp Unit, English / Arabic	3	7
508.033.005.EA	MZX-e SLU4 Weatherproof Status Lamp Unit, English / Arabic	3	7
508.033.050.EA	MZX-e Extinguishing Control Panel English / Arabic	3	7
508.040.001	TXG001-Single Client with 1 panel	4	2
508.040.002	TXG004-Single Client with 2 to 4 panels	4	2
508.040.003	TXG010-Single Client with 5 to 10 panels	4	2
508.040.004	TXG020-Single Client with 11 to 20 panels	4	2
508.040.005	TXG999-Single Client with 21 or above panels	4	2
508.040.011	TXG-C Additional Client license	4	2
508.040.021	TXG-MIN80 Minerva driver license	4	2
508.040.025	TXG-OPC - OPC Alarm / Event & Data Access Server Licence	4	2

Chapter 12 - Index

Product Code	Description	Chapter	Page
508.040.027	TXG-CPP - SIMPLEX CPP driver	4	2
508.040.033	TXG-PBS/FAST2000 DRIVER	4	2
508.040.100	TXG USB Server Dongle/License/Software	4	2
508.200.004	DETEK 1 Zone - water/flood control panel	9	1
508.200.005	DETEK 2 Zone - water/flood control panel	9	1
508.200.006	DETEK 4 Zone - water/flood control panel	9	1
509.023.001	T1200 C1626 4 ZONE PANEL MOTHERBOARD WITH AC PSU	3	6
509.023.001	T1200 C1626 4 ZONE PANEL MOTHERBOARD WITH AC PSU	3	48
509.023.002	T1200 C1626 4 ZONE PANEL MOTHERBOARD WITHOUT AC PSU	3	6
509.023.002	T1200 C1626 4 ZONE PANEL MOTHERBOARD WITHOUT AC PSU	3	48
509.023.003	T1200 C1627 16 ZONE PANEL MOTHERBOARD WITHOUT AC PSU	3	6
509.023.003	T1200 C1627 16 ZONE PANEL MOTHERBOARD WITHOUT AC PSU	3	48
509.023.004	T1200 C1627 16 ZONE PANEL M/BOARD WITHOUT AC PSU FOR T1232	3	6
509.023.004	T1200 C1627 16 ZONE PANEL M/BOARD WITHOUT AC PSU FOR T1232	3	48
509.023.011	T1200 C1626 REPEATER MOTHERBOARD C/W AC PSU	3	6
509.023.011	T1200 C1626 REPEATER MOTHERBOARD C/W AC PSU	3	48
509.023.012	T1200 C1626 REPEATER MOTHERBOARD WITHOUT AC PSU	3	6
509.023.012	T1200 C1626 REPEATER MOTHERBOARD WITHOUT AC PSU	3	48
509.023.021	T1200 C1628 4 ZONE PANEL DISPLAY PCB	3	6
509.023.021	T1200 C1628 4 ZONE PANEL DISPLAY PCB	3	48
509.023.022	T1200 C1628 16 ZONE PANEL DISPLAY PCB	3	6
509.023.022	T1200 C1628 16 ZONE PANEL DISPLAY PCB	3	48
509.023.023	T1200 C1629 32 ZONE PANEL DISPLAY PCB	3	6
509.023.023	T1200 C1629 32 ZONE PANEL DISPLAY PCB	3	48
509.023.031	T1200 C1628 16 ZONE REPEATER DISPLAY PCB	3	6
509.023.031	T1200 C1628 16 ZONE REPEATER DISPLAY PCB	3	48
509.023.032	T1200 C1629 32 ZONE REPEATER DISPLAY PCB	3	6
509.023.032	T1200 C1629 32 ZONE REPEATER DISPLAY PCB	3	48
509.023.042	T1200 C1632 16 ZONE PANEL EXPANSION PCB	3	6
509.023.042	T1200 C1632 16 ZONE PANEL EXPANSION PCB	3	48
509.023.051	T1200 PS136 5.0 AMP 110/230VAC PSU	3	6
509.023.051	T1200 PS136 5.0 AMP 110/230VAC PSU	3	48
509.023.052	T1200 PS40 1.5 AMP 24VDC PSU	3	6
509.023.052	T1200 PS40 1.5 AMP 24VDC PSU	3	48
509.023.061	T1200 & T1200-C SPARE KEY SET	3	6
509.023.061	T1200 & T1200-C SPARE KEY SET	3	48
509.030.117	T561 Extinguishing Release Manual Callpoint.	3	8
514.001.059	Intrinsically Safe Callpoint (BG314NBN)	10	17
514.001.062	IF800Ex MX Digital Addressable Interface Module Assembly	10	9
514.001.063	EXI800 Interface Module	10	10
514.001.107	EX II 2 GD Addressable (EExemd) Manual Alarm Callpoint	10	11
514.001.108	EX II 2 GD Conventional (EExemd) Manual Alarm Callpoint	10	18
514.001.109	MCP220Ex Red ATEX Approved Conventional I.S. Callpoint	10	17
514.001.110.A	MCP230 Weatherproof IP67 red callpoint - ADT Branded	3	26
514.001.110.T	MCP230 Weatherproof IP67 red callpoint - Thorn Branded	3	26
514.001.110.Y	MCP230 Weatherproof IP67 red callpoint - Tyco Branded	3	26
514.001.112	MCP260M Marine callpoint complete with LED indicator - IP67	3	26
514.001.113	MCP250M Marine callpoint complete with LED indicator	3	26
514.001.114	MCP270 Yellow callpoint 'Evacuate' complete with LED indicator	3	26
514.001.142.A	MCP200 Conventional Callpoint without backbox - ADT Branded	3	26
514.001.142.T	MCP200 Conventional Callpoint without backbox - Thorn Branded	3	26
514.001.142.Y	MCP200 Conventional Callpoint without backbox - Tyco Branded	3	26
514.001.143.A	MCP210 red indoor callpoint with LED indicator - ADT Branded	3	26
514.001.143.T	MCP210 red indoor callpoint with LED indicator - Thorn Branded	3	26
514.001.143.Y	MCP210 red indoor callpoint with LED indicator - Tyco Branded	3	26
514.001.160.A	MCP211 red indoor callpoint with evacuate resistors and LED indicator	3	26
514.001.160.T	MCP211 red indoor callpoint with evacuate resistors and LED indicator	3	26
514.001.160.Y	MCP211 red indoor callpoint with evacuate resistors and LED indicator	3	26
514.002.002.A	White keyswitch callpoint 'Bomb Alert' - ADT Branded	3	26
514.800.513	CP840Ex MX Digital Addressable Break Glass Call Point	10	9
514.800.514	CP830Exn Marine MX Digital Addressable Break Glass Call Point	10	9
514.800.603.A	CP820 Indoor Callpoint ADT Branded	2	52
514.800.603.T	CP820 Indoor Callpoint Thorn Branded	2	52
514.800.603.Y	CP820 Indoor Callpoint TYCO Branded	2	52
514.800.604.A	CP830 Outdoor Callpoint ADT Branded	2	52
514.800.604.T	CP830 Outdoor Callpoint Thorn Branded	2	52

Chapter 12 - Index

Product Code	Description	Chapter	Page
514.800.604.Y	CP830 Outdoor Callpoint TYCO Branded	2	52
514.800.609	MCP820M Marine Isolator Callpoint Indoor	2	52
514.800.610	MCP830M Marine Isolator Callpoint Outdoor	2	52
515.001.003	ZF121 Callpoint glasses (Pack of 10) for service spares	3	28
515.001.003	ZF121 Callpoint glasses (Pack of 10) for service spares	3	48
515.001.009	CP100A glass unscored (Pack of 10) for service spares	3	28
515.001.009	CP100A glass unscored (Pack of 10) for service spares	3	48
515.001.010	Walsall Callpoint glasses (Pack of 10) for service spares	3	28
515.001.010	Walsall Callpoint glasses (Pack of 10) for service spares	3	48
515.001.014	CP200 Spare glasses, black Arabic text on a white background	3	28
515.001.014	CP200 Spare glasses, black Arabic text on a white background	3	48
515.001.021	Standard Red surface mounting back box for MCP & CP callpoints	2	53
515.001.021	Standard Red surface mounting back box for MCP & CP callpoints	3	27
515.001.023	CP200 Spare glasses white Dutch text on clear background	3	28
515.001.023	CP200 Spare glasses white Dutch text on clear background	3	48
515.001.024	CP200 Spare glasses, black Arabic/English text	3	28
515.001.024	CP200 Spare glasses, black Arabic/English text	3	48
515.001.025	CP200/500/900 Glasses, clear English text on white background	2	53
515.001.025	CP200/500/900 Glasses, clear English text on white background	3	28
515.001.025	CP200/500/900 Glasses, clear English text on white background	3	48
515.001.026	Black callpoint bezel for CP200/800 models.	2	53
515.001.026	Black callpoint bezel for CP200/800 models.	3	27
515.001.029	STI6530 callpoint STOPPER Flush	2	54
515.001.029	STI6530 callpoint STOPPER Flush	3	29
515.001.030	STI6531 callpoint STOPPER Surface	2	54
515.001.030	STI6531 callpoint STOPPER Surface	3	29
515.001.031	STI6532 callpoint STOPPER Flush With Sounder	2	54
515.001.031	STI6532 callpoint STOPPER Flush With Sounder	3	29
515.001.032	STI6533 callpoint STOPPER Surface With Sounder	2	54
515.001.032	STI6533 callpoint STOPPER Surface With Sounder	3	29
515.001.033	IPO36 Break Seal Kit for STOPPER	2	54
515.001.033	IPO36 Break Seal Kit for STOPPER	3	29
515.001.033	IPO36 Break Seal Kit for STOPPER	3	48
515.001.034	STI1230 Surface fit STOPPER II	2	54
515.001.034	STI1230 Surface fit STOPPER II	2	55
515.001.034	STI1230 Surface fit STOPPER II	3	29
515.001.034	STI1230 Surface fit STOPPER II	3	30
515.001.035	STI3150 callpoint STOPPER II Weatherproof	2	54
515.001.035	STI3150 callpoint STOPPER II Weatherproof	2	55
515.001.035	STI3150 callpoint STOPPER II Weatherproof	3	29
515.001.035	STI3150 callpoint STOPPER II Weatherproof	3	30
515.001.036	STI6535 callpoint STOPPER Surface Weatherproof	2	54
515.001.036	STI6535 callpoint STOPPER Surface Weatherproof	2	55
515.001.036	STI6535 callpoint STOPPER Surface Weatherproof	3	29
515.001.036	STI6535 callpoint STOPPER Surface Weatherproof	3	30
515.001.043	STI6720 Keybox with printed glass	2	56
515.001.043	STI6720 Keybox with printed glass	3	31
515.001.045	Test key for all MCP and CP style callpoints	2	53
515.001.045	Test key for all MCP and CP style callpoints	2	79
515.001.045	Test key for all MCP and CP style callpoints	3	27
515.001.045	Test key for all MCP and CP style callpoints	3	48
515.001.119	EN54 Part 11 Spare Glass for MCP and CP Callpoints	2	53
515.001.119	EN54 Part 11 Spare Glass for MCP and CP Callpoints	2	79
515.001.119	EN54 Part 11 Spare Glass for MCP and CP Callpoints	3	28
515.001.119	EN54 Part 11 Spare Glass for MCP and CP Callpoints	3	48
515.001.127	Deformable operating unit "glass" for use in place of glasses	2	53
515.001.127	Deformable operating unit "glass" for use in place of glasses	3	28
515.001.127	Deformable operating unit "glass" for use in place of glasses	3	48
515.001.128	Callpoint hinged cover for use with MCP callpoints	2	53
515.001.128	Callpoint hinged cover for use with MCP callpoints	3	27
516.015.007	FireRay Reflector 100 x 100mm	2	32
516.015.007	FireRay Reflector 100 x 100mm	3	16
516.015.009	STI9625 Smoke beam/CCTV guard	2	56
516.015.009	STI9625 Smoke beam/CCTV guard	3	31
516.015.020	FireRay 5000 System (50m)	2	32
516.015.020	FireRay 5000 System (50m)	3	16
516.015.021	FR 5000 Detector Head (50m)	2	32
516.015.021	FR 5000 Detector Head (50m)	3	16

Chapter 12 - Index

Product Code	Description	Chapter	Page
516.015.030	FireRay 3000 Beam Detector	2	33
516.015.030	FireRay 3000 Beam Detector	3	17
516.015.031	FR3000 Additional Head Set	2	33
516.015.031	FR3000 Additional Head Set	3	17
516.016.005	LD40 High resistance sensor cable blue - 200M reel	2	34
516.016.005	LD40 High resistance sensor cable blue - 200M reel	3	18
516.016.006	LD40 High resistance sensor cable black - 200M reel	2	34
516.016.006	LD40 High resistance sensor cable black - 200M reel	3	18
516.016.010	LD40 EOL Termination kit (PK10)	2	34
516.016.010	LD40 EOL Termination kit (PK10)	3	18
516.016.011	LD40 In-line Jointing kit (PK10)	2	34
516.016.011	LD40 In-line Jointing kit (PK10)	3	18
516.016.012	LD40 Analyser module with conventional detection zone interface	2	34
516.016.012	LD40 Analyser module with conventional detection zone interface	3	18
516.016.201	B6782-003 EDGE CLIP 2-3mm WEB	2	34
516.016.201	B6782-003 EDGE CLIP 2-3mm WEB	3	18
516.016.202	B6782-024 EDGE CLIP 3-8mm WEB	2	34
516.016.202	B6782-024 EDGE CLIP 3-8mm WEB	3	18
516.016.203	B6782-025 EDGE CLIP 8-13mm WEB	2	34
516.016.203	B6782-025 EDGE CLIP 8-13mm WEB	3	18
516.016.204	B6782-026 EDGE CLIP 14-20mm WEB	2	34
516.016.204	B6782-026 EDGE CLIP 14-20mm WEB	3	18
516.016.205	B6782-004 'T' CLIP	2	34
516.016.205	B6782-004 'T' CLIP	3	18
516.016.206	B6782-005 PIPE CLIP	2	34
516.016.206	B6782-005 PIPE CLIP	3	18
516.016.207	B6782-023 'V' CLIP	2	34
516.016.207	B6782-023 'V' CLIP	3	18
516.016.208	B6782-008 NEOPRENE SLEEVE	2	34
516.016.208	B6782-008 NEOPRENE SLEEVE	3	18
516.016.301	ICAM IAS800 Aspirated Smoke Dual Detector	7	7
516.016.303	ICAM Course Filter (PK10)	7	7
516.016.304	ICAM IAS801 Aspirated Smoke Single Detector	7	7
516.016.305	ICAM IAS802 Aspirated Smoke Dual Detector	7	7
516.016.306	ICAM In-Line Filter Housing	7	7
516.016.310	MZX SensorLaser™ Plus 1/1 – 1 km range, 1 sensor cable	10	27
516.016.311	MZX SensorLaser™ Plus 1/2 – 1 km range, 2 sensor cables	10	27
516.016.312	MZX SensorLaser™ Plus 2/1 – 2 km range, 1 sensor cable	10	27
516.016.313	MZX SensorLaser™ Plus 2/2 – 2 km range, 2 sensor cables	10	27
516.016.314	MZX SensorLaser™ Plus 4/1 – 4 km range, 1 sensor cable	10	27
516.016.315	MZX SensorLaser™ Plus 4/2 – 4 km range, 2 sensor cables	10	27
516.016.316	MZX SensorLaser™ Plus 8/1 – 8 km range, 1 sensor cable	10	27
516.016.317	MZX SensorLaser™ Plus 8/2 – 8 km range, 2 sensor cables	10	27
516.016.318	MZX SensorLaser™ Plus Connection Set	10	27
516.016.319	MZX SensorLaser™ Plus iBox	10	27
516.016.320	MZX SensorLaser™ Plus Relay Controller Set	10	27
516.016.321	MZX SensorLaser™ Plus Power Supply	10	27
516.016.322	MZX SensorLaser™ Plus Safety Cable (per metre)	10	27
516.016.322.C	MZX SensorLaser™ Plus Safety Connector	10	27
516.016.323	MZX Steel Wire Armoured SensorLaser Plus Cable (per metre)	10	27
516.016.323.C	MZX SensorLaser™ Plus Steel Connector	10	27
516.016.324	MZX SensorLaser™ Plus Setting Tool	10	27
516.016.325	MZX SensorLaser™ Plus Relay Extension Set	10	27
516.016.326	MZX SensorLaser™ Plus Zinc Plastic Clamp Set (PK 100)	10	27
516.016.327	MZX SensorLaser™ Plus Steel Plastic Clamp Set (PK 100)	10	27
516.016.328	MZX SensorLaser™ Plus Steel Zinc Clamp Set (PK 100)	10	27
516.016.329	MZX SensorLaser™ Plus Stainless Steel Clamp Set (PK 100)	10	27
516.016.330	MZX SensorLaser™ Plus Spare Unit	10	27
516.016.331	MZX SensorLaser™ Plus Demo Unit	10	27
516.016.332	MZX SensorLaser™ Plus Demo Box	10	27
516.016.333	MZX SensorLaser™ Plus 3/1 – 3 km range, 1 sensor cable	10	27
516.016.334	MZX SensorLaser™ Plus 3/2 – 3 km range, 2 sensor cables	10	27
516.018.001	VLP-012 LaserPLUS Detector, programmer and display	7	3
516.018.002	VLP-002 LaserPLUS Detector and display	7	3
516.018.004	VLS-214 FD7 Scanner, programmer and display with 7 relays	7	4
516.018.005	VLS-204 FD7 Scanner and display with 7 relays	7	4
516.018.007	VLS-314 FD12 Scanner, programmer and display with 12 relays	7	4

Chapter 12 - Index

Product Code	Description	Chapter	Page
516.018.008	VLS-304 FD12 Scanner and display with 12 relays	7	4
516.018.010	VLC-500-RO Relays Only Version (RO)	7	2
516.018.011	VLC-505-VN VESDA net Version (VN)	7	2
516.018.012	VLC-800 MX Addressable Vesda Laser Compact	7	2
516.018.013	VLP-400 LaserPLUS Detector with fire OK LED	7	3
516.018.014	VIO800 MX VESDA Interface	2	45
516.018.016	VLS-600 FD7 Scanner with Fire OK LED	7	4
516.018.019	VLS-700 FD12 Scanner with Fire OK LED	7	4
516.018.020	VLf-250 Vesda Laserfocus (with English overlay)	7	1
516.018.022	VIC-010 LaserFocus VesdaNetwork Card	7	1
516.018.023	VLf-500 Vesda Laserfocus (with English overlay)	7	1
516.018.030	VLC-500-RO Relays Only Version (RO) Marine	7	2
516.018.031	VLC-500-VN Vesdanet Version (VN) Marine	7	2
516.018.032	VRT-J00 Remote Display c/w 7 relays Marine	7	2
516.018.101	VRT-100 Remote programmer	7	5
516.018.102	VRT-200 Remote display including 7 relays	7	5
516.018.103	VRT-300 Remote VESDAnet socket	7	5
516.018.104	VRT-400 Remote scanner display including 7 relays	7	5
516.018.106	VRT-600 Remote detector display no relays	7	5
516.018.107	VRT-700 Remote scanner display no relays	7	5
516.018.108	VRT-800 Remote scanner display with 12 relays	7	5
516.018.119	VRT-J00 Compact Display c/w 7 relays	7	5
516.018.120	VRT-K00 Compact Display no relays	7	5
516.018.201	VSR-2000 19" Sub-rack with 1 detector display and 3 blank	7	6
516.018.203	VSR-2210 19" Sub-rack, 2 detector displays, programmer & 1 blank	7	6
516.018.204	VSR-2221 19" Sub-rack with 3 detector displays and programmer	7	6
516.018.206	VSR-2222 19" Sub-rack with 4 detector displays	7	6
516.018.210	VSR-CUSTOM Custom sub-rack housing	7	6
516.018.214	VSU-E Blank scanner sub-unit with 7 relays	7	6
516.018.219	VSU-J Compact display sub-unit plus 7 relays	7	6
516.018.260	VSU-0 Blank Sub-unit	7	6
516.018.261	VSU-1 Programmer sub-unit	7	6
516.018.262	VSU-2 Detector display sub-unit plus 7 relays	7	6
516.018.264	VSU-4 Scanner display sub-unit plus 7 relays	7	6
516.018.265	VSU-5 Blank sub-unit with 7 relays	7	6
516.018.268	VSU-8 Scanner display sub-unit with 12 relays	7	6
516.018.269	VSU-9 Blank display sub-unit with 12 relays	7	6
516.018.303	LaserPLUS 020-050 IP65 Enclosure	7	6
516.018.401	VHH-100 Hand held programmer plus leads	7	6
516.018.402	VHX-0200 PC link HLI plus leads (MK2)	7	6
516.018.407	VESDA VPS-220 2A 24VDC PSU	7	6
516.018.410	VESDA VPS-250-E 5A 24VDC PSU	7	6
516.018.502	VSP-004 Scanner display (spare)	7	6
516.018.504	VSP-005 Spare filter cartridge	7	6
516.018.505	VSP-019 Filter cover door (spare)	7	6
516.018.506	VSP-006 Spare detector chassis and manifold	7	6
516.018.508	VSP-008 Spare remote termination card 7 relays	7	6
516.018.509	VSP-009 Spare scanner chassis and manifold	7	6
516.018.514	VSP-014 Spare header termination card 7 relays	7	6
516.018.515	VSP-015 Spare aspirator fan	7	6
516.018.901	Aspirating Pipe & Fittings Pipe 25mm diameter	7	8
516.018.902	Aspirating Pipe & Fittings Socket 25mm	7	8
516.018.903	Aspirating Pipe & Fittings Socket Union 25mm	7	8
516.018.904	Aspirating Pipe & Fittings Long Radius bend 90°	7	8
516.018.905	Aspirating Pipe & Fittings Elbow 25mm	7	9
516.018.906	Aspirating Pipe & Fittings End Cap 25mm	7	9
516.018.907	Aspirating Pipe & Fittings Equal Tee 25mm	7	9
516.018.908	Aspirating Pipe & Fittings Pipe Clip 25mm	7	9
516.018.909	Aspirating Pipe & Fittings Socket Adaptor 25mm to 3/4"	7	8
516.018.910	Aspirating Pipe & Fittings Solvent Cement	7	9
516.018.911	Aspirating Pipe & Fittings Capillary Tube Conical Sample Point	7	9
516.018.912	Aspirating Pipe & Fittings Capillary Tube Flush Sample Point	7	9
516.018.915	Aspirating Pipe & Fittings Capillary Tube 10mm Dia	7	9
516.018.918	Aspirating Pipe & Fittings Pipe Cutter	7	10
516.018.920	Aspirating Pipe & Fittings Pipe Ties (Red)	7	10
516.018.921	Wire Burn Test Box	7	10
516.018.923	Smoke Test Wire	7	10

Chapter 12 - Index

Product Code	Description	Chapter	Page
516.018.925	Aspirating Pipe & Fittings In-Line Filter (red)	7	9
516.018.926	Aspirating Pipe & Fittings Replacement Filter Elements (pack of 4)	7	9
516.033.011	T54B Point Type heat detector - 60°C	3	15
516.033.012	T54B Point Type heat detector - 90°C	3	15
516.033.013	T54B Point Type heat detector - 100°C	3	15
516.033.014	T54B Point Type heat detector - 145°C	3	15
516.037.003	S231f+ Triple IR Solar Blind Flame Detector	10	6
516.037.004	S231i+ Triple IR Solar Blind Flame Detector	10	6
516.037.015	S232f+ Triple IR Solar Blind Flame Detector	10	6
516.038.003	S241f+ Triple IR Solar Blind Flame Detector	10	6
516.038.004	S241i+ Triple IR Solar Blind Flame Detector	10	6
516.040.002	S261f+ Triple IR Solar Blind Flame Detector	10	6
516.040.014	FV282f+ Triple IR Solar Blind Flame Detector	10	6
516.041.003	S271f+ Triple IR Solar Blind Flame Detector	10	6
516.041.004	S271i+ Triple IR Solar Blind Flame Detector	10	6
516.052.041.Y	MD611Ex Conventional Fixed Temperature Heat Detector	10	16
516.052.051.Y	MD601Ex Conventional Rate of Rise Heat Detector	10	16
516.054.011.Y	MR601TEEx Conventional High Performance Optical Smoke Detector	10	16
516.061.001.Y	MDU601Ex Enhanced Carbon Monoxide Fire & Heat Detector	10	16
516.100.013	Test Gas Kit - 12 L can of 2.5% methane, adaptor and tube	2	31
516.100.014	Test Gas - 12 L can of 2.5% methane	2	31
516.100.050	GD210 Flammable Gas Detector 4 - 20mA interface	2	31
516.100.051	Spare Flammable Gas Detector Sensor	2	31
516.100.051	Spare Flammable Gas Detector Sensor	2	79
516.100.052	Spare Flammable Gas Detector PCB	2	31
516.100.052	Spare Flammable Gas Detector PCB	2	79
516.200.004	DETEK SPS/V Vertical Mount Probe Sensor c/w cover	9	3
516.200.006	DETEK SFD Sensor Pad - Face Down	9	2
516.200.007	DETEK SFD/C Cover for Sensor Pad	9	2
516.200.010	DETEK CD/5 metre length of sensing cable	9	2
516.200.011	DETEK CD/10 10 metre length of sensing cable	9	2
516.200.012	DETEK SOL Start of Line for Sensing Cable	9	2
516.200.013	DETEK EOL End of Line for Sensing Cable	9	2
516.200.014	DETEK FF1 Fixing Clips for Sensing Cable	9	3
516.200.015	DETEK CDT Warning Labels for Sensing Cable	9	3
516.200.016	DETEK SFU Sensor Pad - Face Up	9	2
516.300.006	FV311S Flameproof Detector - cable gland entries - no camera	10	4
516.300.007	FV311SC-N Fproof Detector - cable gland entries - NTSC camera	10	4
516.300.008	FV311SC Flameproof Detector - cable gland entries - PAL camera	10	4
516.300.055	FV312S Flameproof Detector - sealed back box - no camera	10	4
516.300.057	FV312SC Flameproof Detector - sealed back box - PAL camera	10	4
516.600.001	601P Optical Smoke Detector	3	12
516.600.002	601PH High Performance Optical Smoke Detector	3	12
516.600.003	601H-R Rate of Rise Heat Detector	3	12
516.600.004	601CH Enhanced Carbon Monoxide Fire Detector	3	12
516.600.005	601I Ion Chamber Smoke Detector	3	13
516.600.006	601F Solar Blind Infra Red Flame Detector	3	13
516.600.007	601F-M Solar Blind Infra Red Flame Detector Marine	3	13
516.600.033	631H-F Fixed Temperature 90°C Heat Detector LPCB /Marine	3	12
516.600.066	601FEx Infra-Red Flame Detector	10	16
516.600.067	601FEx-M Infra-Red Flame Detector (Marine)	10	16
516.600.201	601P-M Optical Smoke Detector Marine Tyco branded	3	12
516.600.202	601PH-M High Performance Optical Smoke Detector Marine	3	12
516.600.203	601H-R-M Rate of Rise Heat Detector Marine Tyco branded	3	12
516.600.204	601CH-M Enhanced Carbon Monoxide Fire Detector Marine	3	12
516.600.214	611H-F Fixed Temperature 60°C Heat Detector LPCB /Marine	3	12
516.800.006	801F LPCB Approved	2	31
516.800.007	811F Marine Approved	2	31
516.800.066	801FEx I.R. Flame Detector	10	8
516.800.067	811FEx Marine I.R. Flame Detector	10	8
516.800.515.A	801I Ionisation detector ADT branded	2	31
516.800.515.T	801I Ionisation detector Thorn branded	2	31
516.800.515.Y	801I Ionisation detector Tyco branded	2	31
516.800.518	801PS High sensitivity smoke detector	2	31
516.800.530	801PHEX Optical Smoke + Heat Detector	10	8
516.800.531	801CHEX Carbon Monoxide + Heat Detector	10	8
516.800.532	801HEX Heat Detector	10	8

Chapter 12 - Index

Product Code	Description	Chapter	Page
516.800.534	811PHExn Marine Optical Smoke + Heat Detector	10	8
516.800.535	811CHExn Marine Carbon Monoxide + Heat Detector	10	8
516.800.536	811HExn Marine Heat Detector	10	8
516.800.905	801RB Relay base	2	37
516.800.908	801RIL remote indication LED	2	38
516.800.909	800HL indication lamp	2	38
516.800.910	802SB MX Loop Powered Sounder Base	2	37
516.800.911	901SB Universal Sounder Base	2	37
516.800.912	912SB Universal UL Sounder Base	2	37
516.800.913	812SB MX Loop Powered UL Sounder Base	2	37
516.800.915	MX Address flags (pack of 100)	2	39
516.800.917	800RT Detector Removal Tool	5	1
516.800.922	MX Service tool, Spare programming lead	2	76
516.800.922	MX Service tool, Spare programming lead	2	79
516.800.923	MX SERVICE UK - ACCESSORY KIT	2	77
516.800.924	MX Service tool, Spare pins for programming lead pk of 10	2	76
516.800.924	MX Service tool, Spare pins for programming lead pk of 10	2	79
516.800.931	Address flag labels Loop A - White	2	39
516.800.932	Address flag labels Loop B - Yellow	2	39
516.800.933	Address flag labels Loop C - Purple	2	39
516.800.934	Address flag labels Loop D - Green	2	39
516.800.935	Address flag labels Loop E - Grey	2	39
516.800.936	Address flag labels Loop F - Blue	2	39
516.800.937	Address flag labels Loop G - Orange	2	39
516.800.938	Address flag labels Loop H - Red	2	39
516.800.941	Tyco MZX AVR Programmer	2	77
516.800.956	SAB 801 Low Power Sounder Addressable Beacon	2	37
516.800.957	LPSB3000 Sounder L/P addressable base	2	58
516.800.958	LPAV3000 Sounder beacon L/P addressable base	2	58
516.800.959	DAB3-4 Mounting Flange – type B for conduit (pk of 10)	2	58
516.800.960	LPSY800-R L/P Symphoni Sounder (indoor use) red	2	59
516.800.961	LPSY800-W LP Symphoni Sounder (indoor use) white	2	59
516.800.962	LPSY865 L/P Symphoni Sounder IP65 (out door use)	2	59
516.800.963	LPAV800-R L/P Symphoni Sounder/Beacon (indoor use) red	2	59
516.800.964	LPAV800-W L/P Symphoni Sounder/Beacon (indoor use) white	2	59
516.800.965	LPAV865 L/P Symphoni Sounder/ Beacon IP65 (outdoor use)	2	59
516.830.051	830PH Photo Heat Detector	2	29
516.830.052	830P Photo Detector	2	29
516.830.053	830H Heat Detector	2	30
516.830.054	830PC 3oTec Triple Sensor Detector	2	30
516.850.051	850PH Photo Heat Detector with built in line isolator	2	29
516.850.052	850P Photo Detector	2	29
516.850.053	850H Heat Detector with built in line isolator	2	30
516.850.054	850PC 3oTec Triple Sensor Detector with built in line isolator	2	30
516.850.055	851PH Photo Heat Detector Marine Only	2	29
516.850.900	850EMT Engineering Management Tool	2	76
517.001.120	System 601 EOL Unit (Pk 10)	10	16
517.001.120	System 601 EOL Unit (PK10)	10	24
517.001.184	S200+ Detector Mounting Bracket	10	5
517.001.196	UC2 4 Way Barrier Housing	10	24
517.001.198	MT2 2 Way Zener Barrier Housing	10	24
517.001.199	MT5 5 Way Zener Barrier Housing	10	24
517.001.200	MT12 12 Way Zener Barrier Housing	10	24
517.001.201	MTL728 Single Channel Zener Safety Barrier	10	23
517.001.202	MTL788 Dual Channel Zener Safety Barrier	10	23
517.001.205	ERL7 Earth rail for I.S. systems	10	24
517.001.206	ETM7 Earth termination connection system	10	24
517.001.207	IMB7 Insulating mounting block	10	24
517.001.224	Adaptor for Solo Access Poles	5	2
517.001.226	1.13 metre Solo Extension Pole	5	1
517.001.230	Solo Telescopic Pole extends from 1.26 to 4.5 metres	5	1
517.001.235	Address key extractor tool	5	2
517.001.236	Testifier Smoke, Heat & CO Detector Test Kit	5	1
517.001.237	6 x Replacement smoke capsules for use with Testifire	5	1
517.001.238	6 x Replacement CO capsules for use with Testifire	5	1
517.001.239	Battery Baton for use with Testifire and Heat Detector Tester	5	2

Chapter 12 - Index

Product Code	Description	Chapter	Page
517.001.240	Detector Removal Tool Universal	5	1
517.001.243	Fast Charger for use with Solo Battery Batons	5	2
517.001.247	DX170 Enclosure	10	10
517.001.248	DX070 Enclosure	10	10
517.001.254	Cordless Heat Detector Test Kit	5	2
517.001.255	Dispenser for Solo Smoke and CO Canister	5	2
517.001.256	Solo Smoke Detector Tester aerosol canister	5	2
517.001.259	Pepperl+Fuchs KFD0-CS-EX1.54 Galvanic Isolator	10	10
517.001.262	Solo CO Detector Tester gas canister	5	2
517.001.263	S200+ Weather Protection Assembly	10	5
517.001.264	Protective carry and storage bag for the Solo / Testifire	5	1
517.001.266	S200+ Spares Kit & Sealant	10	5
517.001.267	Testifier Smoke & Heat Detector Test Kit	5	2
517.001.301	MTL7728+ Zener Safety Barrier for conventional detection circuits	10	23
517.001.302	MTL5561 2 CHANNEL GALVANIC ISOLATOR	10	23
517.001.304	MTL5525 I.S. SOUNDER DRIVER	10	10
517.001.304	MTL5525 I.S. SOUNDER DRIVER	10	23
517.017.005	Aspirating Pipe & Fittings Sampling Point Label	7	10
517.017.006	Aspirating Pipe & Fittings Pipe Label	7	10
517.025.028	DPS450 Probe tube stainless steel 450mm and exhaust	2	40
517.025.028	DPS450 Probe tube stainless steel 450mm and exhaust	3	23
517.025.029	DPS600 Probe tube stainless steel 600mm and exhaust	2	40
517.025.029	DPS600 Probe tube stainless steel 600mm and exhaust	3	23
517.025.030	DPS750 Probe tube stainless steel 750mm and exhaust	2	40
517.025.030	DPS750 Probe tube stainless steel 750mm and exhaust	3	23
517.025.031	DPS900 Probe tube stainless steel 900mm and exhaust	2	40
517.025.031	DPS900 Probe tube stainless steel 900mm and exhaust	3	23
517.025.033	DPS1500 Probe tube stainless steel 1500mm and exhaust	2	40
517.025.033	DPS1500 Probe tube stainless steel 1500mm and exhaust	3	23
517.025.035	SMP69 Stainless Steel Duct Probe Unit	2	40
517.025.035	SMP69 Stainless Steel Duct Probe Unit	3	23
517.025.049	DPK4 - Duct Probe with MZX detector base 5" - 5B	2	41
517.025.049	DPK4 - Duct Probe with MZX detector base 5" - 5B	3	24
517.025.050	DPK4I - Duct Probe with MZX detector base 5" with isolator - 5BI	2	41
517.025.051	DPK600 - Duct Probe Tube 600 mm	2	41
517.025.051	DPK600 - Duct Probe Tube 600 mm	3	24
517.025.052	DPK1500 - Duct Probe Tube 1500 mm	2	41
517.025.052	DPK1500 - Duct Probe Tube 1500 mm	3	24
517.025.053	DPK2800 - Duct Probe Tube 2800 mm	2	41
517.025.053	DPK2800 - Duct Probe Tube 2800 mm	3	24
517.025.054	DPKM - Duct Probe Mounting Bracket	2	41
517.025.054	DPKM - Duct Probe Mounting Bracket	3	24
517.025.055	Spare Filters for DPK4/DPK4I (PK of 10)	2	41
517.025.055	Spare Filters for DPK4/DPK4I (PK of 10)	3	24
517.035.007	M520 Ancillary Cover	2	49
517.035.010	K2142 White plastic surface mount backbox	2	50
517.035.011	K2214 ALM Metal Surface Mount backbox	2	50
517.035.014	8621C Steel Flush Mount MK backbox	2	50
517.035.015	QFB/2 Dry lining flush mount backbox	2	50
517.050.002.A	Line Shorting Adapter	2	31
517.050.005	4" Detector Base Locking Pin Kit (PK100)	2	37
517.050.005	4" Detector Base Locking Pin Kit (PK100)	3	21
517.050.011	Steel Protective Detector Cage	2	38
517.050.011	Steel Protective Detector Cage	3	22
517.050.015	Volume Adjustment Tool	2	37
517.050.015	Volume Adjustment Tool	3	21
517.050.022	Volume Pot Spare Cover (1 sheet of 144)	2	37
517.050.022	Volume Pot Spare Cover (1 sheet of 144)	3	21
517.050.023	5BEX 5" Universal Ex Base	10	16
517.050.041	4B 4" Detector Base	2	35
517.050.041	4B 4" Detector Base	2	72
517.050.041	4B 4" Detector Base	3	20
517.050.041	4B 4" Detector Base	3	46
517.050.041	4B 4" Detector Base	3	47
517.050.042	4B-C 4" Continuity Base	2	35
517.050.043	4B-I 4" Isolator Base	2	35
517.050.045	4B-D 4" Diode Continuity Base	3	20

Chapter 12 - Index

Product Code	Description	Chapter	Page
517.050.045	4B-D 4" Diode Continuity Base	3	46
517.050.045	4B-D 4" Diode Continuity Base	3	47
517.050.051	4B-DHM Deckhead Mount	2	38
517.050.051	4B-DHM Deckhead Mount	3	22
517.050.052	4B-EM 4" Euro Mount	2	38
517.050.052	4B-EM 4" Euro Mount	3	22
517.050.054	4B-6A 4" to 6" Base Adaptor	2	36
517.050.054	4B-6A 4" to 6" Base Adaptor	3	20
517.050.056	CTA-BB CTA Back Box	2	36
517.050.056	CTA-BB CTA Back Box	3	20
517.050.057	CTA-BC CTA Bezel and Clamp	2	36
517.050.057	CTA-BC CTA Bezel and Clamp	3	20
517.050.058	CTA-AP CTA Adaptor Plate	2	36
517.050.058	CTA-AP CTA Adaptor Plate	3	20
517.050.060	Ceiling Tile Adaptor Kit	2	36
517.050.060	Ceiling Tile Adaptor Kit	3	20
517.050.501	Sample set of coloured detector covers and bases - set of 10	2	30
517.050.502	Detector Cover & Base in Orange Semi Gloss-pack of 10	2	30
517.050.503	Detector Cover & Base in Yellow Gloss-pack of 10	2	30
517.050.504	Detector Cover & Base in Matt Green-pack of 10	2	30
517.050.505	Detector Cover & Base in Matt Red-pack of 10	2	30
517.050.506	Detector Cover & Base in Matt Brown-pack of 10	2	30
517.050.507	Detector Cover & Base in Blue Gloss-pack of 10	2	30
517.050.508	Detector Cover & Base in Pink Gloss-pack of 10	2	30
517.050.509	Detector Cover & Base in Metallic Silver-pack of 10	2	30
517.050.510	Detector Cover & Base in Metallic Gold-pack of 10	2	30
517.050.511	Detector Cover & Base in Matt Black-pack of 10	2	30
517.050.603	DHM-5B deckhead mounting	10	16
517.050.612	Base Accessory terminal kit (pack of 10)	2	38
517.050.612	Base Accessory terminal kit (pack of 10)	3	22
517.050.614	CW-5B Detector Cage	2	38
517.050.614	CW-5B Detector Cage	3	22
517.300.001	MB300 Mounting Bracket	10	4
517.300.002	WH300 Stainless Steel Weather Hood	10	4
517.300.005	JB300 Exe Junction Box	10	4
517.300.006	MK300 Field Spares Kit	10	4
517.300.021	WT300 Walk-test Controller	10	4
517.300.022	CTI300 Off-line Configuration Tool Kit	10	4
519.001.008	Door Release Button	6	3
525.001.005	Fire Notice Frame A4 Dimensions: 212mm x 297mm	6	4
525.001.006	Fire Notice Frame A3 Dimensions: 280mm x 356mm	6	4
525.001.007	Fire Notice Frame A1 Dimensions: 483mm x 737mm	6	4
525.001.008	Fire Notice Frame A2 Dimensions: 483mm x 367mm	6	4
527.001.028	Micro-switch Lock Keep & Back-plate For Deadlock	3	8
540.001.030	Xenon Beacon Low profile clear 24Vdc 1 watt	2	71
540.001.030	Xenon Beacon Low profile clear 24Vdc 1 watt	3	44
540.001.031	Xenon Beacon Low profile blue 24Vdc 1 watt	2	71
540.001.031	Xenon Beacon Low profile blue 24Vdc 1 watt	3	44
540.001.032	Xenon Beacon Low profile amber 24Vdc 1 watt	2	71
540.001.032	Xenon Beacon Low profile amber 24Vdc 1 watt	3	44
540.001.033	Xenon Beacon Low profile red 24Vdc 1 watt	2	71
540.001.033	Xenon Beacon Low profile red 24Vdc 1 watt	3	44
540.001.038	XB8 Intrinsically Safe Xenon Beacon	10	20
540.001.039	XB11 Flameproof Xenon Beacon	10	22
540.003.006	Remote Indication LED	3	22
540.007.001	E1 Single Red lamp unit Heavy Duty IP67 Cast Aluminium	3	8
540.007.002	E3 Red/Amber/Green lamp unit	3	8
540.011.012	Single gang flush mount LED (red)/Buzzer Unit	2	70
540.011.012	Single gang flush mount LED (red)/Buzzer Unit	3	43
540.011.013	Single gang surface mount LED (red)/Buzzer Unit	2	70
540.011.013	Single gang surface mount LED (red)/Buzzer Unit	3	43
545.800.004	LIM800 Ancillary Line Isolator Module	2	43
545.800.033	LIM800 Ancillary Line Isolator Module c/w front cover	2	43
546.004.005	Intrinsically safe sounder circuit interface module	10	23
547.004.002	DIN rail mounting bracket for MZX ancillary module	2	49
555.800.001	MIM800 mini-input module	2	42
555.800.002	CIM800 contact input monitor	2	42

Chapter 12 - Index

Product Code	Description	Chapter	Page
555.800.012	DIM800 detector input monitor	2	42
555.800.032	CIM800 Module c/w Front Cover	2	42
555.800.042	DIM800 Module c/w front cover	2	42
555.800.063	SIO800 Single Input/Output Module	2	43
555.800.064	SIO800 Single Input/Output Module c/w Front Cover	2	43
555.800.065	MIO800 Multi I/O Module	2	45
555.800.066	BDM800 Beam Detector Module c/w Cover	2	45
555.800.067	BTM800 Beam Terminal Module c/w Cover	2	45
555.800.069	TSM800 Door Control Module	2	45
555.800.070	QMO850 Quad Monitored Output Module	2	46
555.800.071	QIO850 Quad Input/Output Module	2	46
555.800.072	SIO800 Single Input/Output Module in EExd Housing	10	14
555.800.073	QRM850 Quad Relay Output Module	2	46
557.001.040.A	Mark 2 Sounder Cap (ADT Branded)	2	58
557.001.040.A	Mark 2 Sounder Cap (ADT Branded)	3	21
557.001.040.Y	Mark 2 Sounder Cap (Tyco Branded)	2	58
557.001.040.Y	Mark 2 Sounder Cap (Tyco Branded)	3	21
557.180.005	80 way Mimic driver module	2	7
557.180.005	80 way Mimic driver module	2	19
557.180.016	XIOM Input/Output Expansion Module (16 Way)	2	7
557.180.016	XIOM Input/Output Expansion Module (16 Way)	2	21
557.180.022	Terminal chamber PCB assembly	2	9
557.180.025	Minerva Comms Driver Module	4	6
557.180.052	Serial Printer Driver Kit	2	20
557.180.052	Serial Printer Driver Kit	2	79
557.180.053	Isolated RS485 IC (for U16)	2	20
557.180.053	Isolated RS485 IC (for U16)	2	79
557.180.095	STK8 stacking kit	2	49
557.180.096.A	ANC-8 MINERVA ancillary housing	2	49
557.180.097.A	ANC-3 MINERVA ancillary housing	2	49
557.180.148.A	TLO/TLD Housing - ADT branded	4	6
557.180.151	RS232/422 converter for LCD Repeater	2	24
557.180.208	MX2 Spare Keys	2	79
557.180.209	Keypad assembly for use with MX2 controllers (spare)	2	79
557.180.219	PC to TLI800EN Network Card Connection Cable	4	2
557.180.220	LQ 300+ Printer Ribbon (spare)	2	24
557.180.239	DOT Matrix printer 80 columns LQ 300+	2	24
557.180.423	TM520 timer module (non addressable)	2	43
557.180.452	Marine 19" rack mount kit for use with surface mounting housings	2	9
557.180.454	Marine Bulkhead Mount	2	9
557.180.699	TLD 530 ThornNet/MXNet direct line driver PCB	4	6
557.200.003	MX4000 Two to Four Loop Panel – Shallow Back Box	2	5
557.200.004	MX4000 Two to Eight Loop Panel – Deep Back Box	2	5
557.200.005	MX-BBX 17Ah shallow expansion and battery box	2	6
557.200.006	MX-DPBX 38Ah deep expansion and battery box	2	6
557.200.009	MX4000 Two to Four Loop Panel - Flush Back Box	2	5
557.200.012	MXR Repeater with shallow backbox (24Vdc)	2	7
557.200.013	MXR-PSU Repeater and addressable PSU (120-240 Vac)	2	7
557.200.014	MXAPSU17 Boxed Addressable PSU (17A/H)	2	16
557.200.015	MXAPSU38 Boxed Addressable PSU (38A/H)	2	16
557.200.016	MX-BATT Deep Battery Box (322H x 442W x 217D mm)	2	6
557.200.017	MXR-F Repeater with flush backbox (24Vdc)	2	7
557.200.019	MX-BBX-F 17Ah shallow flush expansion and battery box	2	6
557.200.029	MX Paging System Pager Transmitter	2	27
557.200.030	Remote LCD Repeater MKII	2	24
557.200.039	TLI800EN Network Interface in Housing c/w PSU	4	4
557.200.071	Fire Tek Pro Paging System Paging Transmitter	2	26
557.200.071	Fire Tek Pro Paging System Paging Transmitter	3	10
557.200.074	Fire Tek Pro Paging System 40 Character Alpha Numeric Pager	2	26
557.200.074	Fire Tek Pro Paging System 40 Character Alpha Numeric Pager	3	10
557.200.076	Fire Tek Pro Paging System 1/2 wave dipole antenna	2	26
557.200.076	Fire Tek Pro Paging System 1/2 wave dipole antenna	3	10
557.200.077	Fire Tek Pro Paging System Wall mounting folded dipole antenna	2	26
557.200.077	Fire Tek Pro Paging System Wall mounting folded dipole antenna	3	10
557.200.078	Fire Tek Pro Paging System Pole mounting folded dipole antenna	2	26
557.200.078	Fire Tek Pro Paging System Pole mounting folded dipole antenna	3	10
557.200.079	Fire Tek Pro Paging System 5 metre antenna feeder cable	2	26

Chapter 12 - Index

Product Code	Description	Chapter	Page
557.200.079	Fire Tek Pro Paging System 5 metre antenna feeder cable	3	10
557.200.080	Fire Tek Pro Paging System 10 metre antenna feeder cable	2	26
557.200.080	Fire Tek Pro Paging System 10 metre antenna feeder cable	3	10
557.200.203	MX2-210 Two loop c/w LEDs shallow housing	2	4
557.200.205	MX2-211 Two loop c/w LEDs deep housing	2	4
557.200.207	MX2-XB0 Expansion Box Shallow	2	4
557.200.208	MX2-XB1 Expansion Box Deep	2	4
557.200.209	MX2-FB Panel/repeater flush mounting bezel	2	4
557.200.210	MX2-FBX Expansion box flush mounting bezel	2	4
557.200.501	MZX125 1 loop 16 Zone Fire Controller	2	2
557.200.502	MZX250 1 loop 32 Zone Fire Controller	2	2
557.200.503	MZX251 1 loop 32 Zone Fire Controller	2	2
557.200.506	MZX252 2 loop 32 Zone Fire Controller	2	2
557.200.508	MZX253 2 to 4 loop 64 Zone FireController	2	2
557.200.509	MZX254 2 to 4 loop 240 Zone Fire Controller (No Zonal LED'S)	2	2
557.200.520	MZX16R 16 Zone Repeater (mains powered)	2	2
557.200.521	MZX32R 32 Zone Repeater (mains powered)	2	2
557.200.523	MZXDR 240 Zone Repeater No Zonal Led's (24VDC powered)	2	2
557.200.526	MZX64DR 64 Zone Repeater (24VDC powered)	2	2
557.200.530	PSU A17 17Ahr 5A Addressable expansion PSU	2	3
557.200.531	PSU A38 38Ahr 5A Addressable expansion PSU	2	3
557.200.600	T2000 Two To Eight Loop Marine Panel (Stainless steel enclosure)	2	9
557.200.601	T2000R Marine Repeater with 240Vac PSU (Stainless steel)	2	10
557.200.602	T2000B Battery Box (Stainless steel enclosure)	2	9
557.200.604	T2000R Marine Repeater 24Vdc (Stainless steel)	2	10
557.200.605	T2000 BM Battery Box (Mild steel enclosure)	2	9
557.200.606	T2000 RMRS Door Stay Kit	2	9
557.200.606	T2000 RMRS Door Stay Kit	2	10
557.200.610	T2000 Standard Two to Eight Loop Marine Panel (Mild steel)	2	9
557.200.611	T2000R Marine Repeater with 240Vac PSU (Mild steel)	2	10
557.200.612	T2000R Marine Repeater 24Vdc (Mild steel)	2	10
557.200.620	T2000CV 3 loop marine panel (mild steel back box)	2	9
557.200.621	T2000R CV Marine Indicating Repeater 24Vdc (Mild steel)	2	10
557.201.210	Dual power supply mounting kit	2	79
557.201.211	Ancillary/expansion board mounting kit	2	4
557.201.216	T2000 XLM 8-Loop Mounting Kit	2	9
557.201.231	MX2 PSU830 Dual PSU Kit	2	16
557.201.232	PTM800 Power Terminal Module	2	16
557.201.233	PSU 830 T2000/T2000R Conversion Kit	2	9
557.201.233	PSU 830 T2000/T2000R Conversion Kit	2	10
557.201.234	PSU 830 T2000 120VAC Kit	2	9
557.201.234	PSU 830 T2000 120VAC Kit	2	10
557.201.300	BFP801Blank Half Module - Grey Overlay	2	79
557.201.303	DIN Rail Mounting Kit	2	45
557.201.303	DIN Rail Mounting Kit	2	66
557.201.303	DIN Rail Mounting Kit	2	69
557.201.303	DIN Rail Mounting Kit	3	39
557.201.303	DIN Rail Mounting Kit	3	42
557.201.306	Standard MX Expansion backbox and chassis plate	2	79
557.201.307	MZX250 17Ah Battery Clamp	2	2
557.201.310	Deep MX Expansion backbox and chassis plate	2	79
557.201.401	D800 IP55 Ancillary Housing	2	45
557.201.401	D800 IP55 Ancillary Housing	2	49
557.201.410	IP66 Housing for Quad I/O Modules	2	46
557.201.410	IP66 Housing for Fire-Cryer® Plus Extinguishing PCB	2	66
557.201.410	IP66 Housing for Fire-Cryer® Plus Extinguishing PCB	2	69
557.201.410	IP66 Housing for Fire-Cryer® Plus Extinguishing PCB	3	39
557.201.410	IP66 Housing for Fire-Cryer® Plus Extinguishing PCB	3	42
557.201.501	Semi-Flush Bezel for MZX250/251/252/253/254/MZX32R	2	2
557.201.502	Flush Bezel for MZX125/MZX16R/MZXC+ 4/8/16 Zone Panel & Repeater	2	2
557.201.502	Flush Bezel for MZX125/MZX16R/MZXC+ 4/8/16 Zone Panel & Repeater	3	4
557.201.503	Accessory mounting plate for std modules, IOB800 & LIM800	2	2
557.201.505	MZX251/ 252 38Ah Battery Clamp	2	2
557.201.508	MZX/MZXC/MZXE Spare Key Set	2	79
557.201.508	MZX/MZXC/MZXE Spare Key Set	3	48
557.201.508	MZX/MZXC/MZXE Spare Key Set	3	48
557.201.510	Rack mount kit for MZX 125	2	2

Chapter 12 - Index

Product Code	Description	Chapter	Page
557.201.511	Rack mount kit for MZX 250	2	2
557.201.512	Rack Mount Kit for MZX 251/252/253/254	2	2
557.201.513	Document Holder attachment (used with ANC125/250/251)	2	3
557.201.516	PSU monitor kit (includes MIM800)	2	3
557.201.518	M520 Anc Fitting Kit – req'd for older M520 modules	2	3
557.201.519	Comms Interface mounting plate (MZX250/251/252/253/254 only)	2	2
557.201.520	MZX251/252/253/254 24Ah Battery Clamp	2	2
557.202.000	FIM801 field interface module with one MX loop driver	2	15
557.202.000	FIM801 field interface module with one MX loop driver	2	79
557.202.001	FIM802 field interface module with two MX loop drivers	2	15
557.202.001	FIM802 field interface module with two MX loop drivers	2	79
557.202.002	CPU800 Central Processor Unit	2	13
557.202.002	CPU800 Central Processor Unit	2	79
557.202.003	PSM800 Power Supply Unit	2	79
557.202.004	LBM800 Loop Booster Module PCB	2	79
557.202.006	IOB800 (8in/8out) expansion board	2	5
557.202.006	IOB800 (8in/8out) expansion board	2	7
557.202.006	IOB800 (8in/8out) expansion board	2	21
557.202.007	XLM800 2-Loop Expansion Card	2	4
557.202.007	XLM800 2-Loop Expansion Card	2	5
557.202.007	XLM800 2-Loop Expansion Card	2	14
557.202.007	XLM800 2-Loop Expansion Card	2	79
557.202.008	FIM801CV for Marine T2000CV	2	15
557.202.008	FIM801CV for Marine T2000CV	2	79
557.202.012	MPM800 multi-purpose interface module	2	20
557.202.013	OCM800 with Inserts - English	2	17
557.202.013	OCM800 with Inserts - English	2	79
557.202.019	ODM800 Operator Display Module	2	18
557.202.019	ODM800 Operator Display Module	2	79
557.202.020	COM820 20-Way Status/Command Module	2	4
557.202.020	COM820 20-Way Status/Command Module	2	19
557.202.020	COM820 20-Way Status/Command Module	2	79
557.202.021	ANN840 40-Way Alarm/Fault LED Module	2	4
557.202.021	ANN840 40-Way Alarm/Fault LED Module	2	19
557.202.021	ANN840 40-Way Alarm/Fault LED Module	2	79
557.202.022	ANN880 80-Way Alarm LED Module	2	4
557.202.022	ANN880 80-Way Alarm LED Module	2	19
557.202.022	ANN880 80-Way Alarm LED Module	2	79
557.202.024	PRN800 Printer c/w front cover module	2	4
557.202.024	PRN800 Printer c/w front cover module	2	24
557.202.027	APM800 addressable power supply monitor	2	42
557.202.028	RSM800 PSU Module (24Vdc)	2	7
557.202.028	RSM800 PSU Module (24Vdc)	2	79
557.202.030	PSU 830 Panel Fixing Conversion Kit	2	16
557.202.031	PSU 830 Small Chassis Plate Conversion Kit	2	16
557.202.044	PSU 830K Power Expansion Kit	2	16
557.202.046	MX CCU3/C-MXMB MX to MOD Bus Interface	4	6
557.202.050	PSM800 Temp Sensor Accessory Kit	2	79
557.202.073	2 Loop expansion kit for MZX253 (includes XLM loop card)	2	2
557.202.080	TLI800EN MXNet network card & cable	2	4
557.202.080	TLI800EN MXNet network card & cable	2	5
557.202.080	TLI800EN MXNet network card & cable	4	4
557.202.081	FOM800 Fibre Optic Module	4	4
557.202.090	RS800 WebWay IP/ GPRS	2	23
557.202.091	RS800 WebWay IP for remote IP services only	2	23
557.202.093	Enclosure for RS-800	2	23
557.202.100	FB800 fuse board (15 way)	2	21
557.202.113	PSB to FIM Cable	2	79
557.202.116	MX-FIM Modem Lead	2	75
557.202.117	Serial printer cable for MPM800 or FIM800	2	20
557.202.117	Serial printer cable for MPM800 or FIM800	2	24
557.202.118	MXConsys Download lead	2	75
557.202.120	MX-Minerva Bridge Kit (17AH)	4	7
557.202.121	MX Minerva Bridge Kit (38AH)	4	7
557.202.123	MX Bridge CCU3/C-MX Bridge	4	6
557.202.127	VDR Cable For a Standalone panel, Com port 3	2	9
557.202.128	VDR Cable for a networked system, Com port 1	2	9

Chapter 12 - Index

Product Code	Description	Chapter	Page
557.202.128	VDR Cable for a networked system, Com port 1	2	24
557.202.135	BACnet Converter for MZX	2	22
557.202.200	DCM800 MX2 Display Control Module (without LCD assy)	2	4
557.202.200	DCM800 MX2 Display Control Module (without LCD assy)	2	79
557.202.204	MX2 Battery housing	2	4
557.202.205	MX2 Battery and Expansion Housing (65AH)	2	4
557.202.206	MX2 expansion aperture installation kit	2	4
557.202.206	MX2 expansion aperture installation kit	2	79
557.202.208	MX2 8 Loop Expansion Kit	2	4
557.202.208	MX2 8 Loop Expansion kit	2	79
557.202.209	MX2 LCD Assembly (Spare)	2	4
557.202.209	MX2 LCD Assembly (Spare)	2	79
557.202.210	PSU830 Power Supply Module	2	16
557.202.210	PSU830 Power Supply Module	2	79
557.202.298	MX Service Case	2	78
557.202.601	DCM816 16 zone display PCB for MZX125	2	79
557.202.602	DCM832 32 zone display PCB for MZX250/251/252	2	79
557.202.608	PMM800 Power monitor module	2	79
557.202.609	BAQ60T24 2.5A MZX PSU	2	79
557.202.610	BAQ140T24 5A MZX PSU	2	79
557.202.611	PMM805 Power Monitor Module - 5V Repeater	2	79
557.202.612	PMM840 Power Monitor Module - 40V Loop Power	2	79
557.202.613	DCM864R Spare Display / Control PCB for MZX253	2	79
557.202.614	DCM8240 240 zone display PCB for MZX254 and MZXDR	2	79
557.202.622	ANC125 Ancillary Housing (Small - matches MZX125)	2	3
557.202.623	ANC250 Ancillary Housing (Large - matches MZX250)	2	3
557.202.624	ANC251 Ancillary Housing (Deep - matches MZX251/252/253/254)	2	3
557.202.625	ANC125-A Ancillary Housing, One Aperture (Small)	2	3
557.202.626	ANC250-A Ancillary Housing, Two Aperture (Large)	2	3
557.202.627	ANC251-A Ancillary Housing, Two Aperture (Deep)	2	3
557.203.001	MXConsys Dongle and license (parallel)	2	75
557.203.002	MXRemote dongle and license (parallel)	2	75
557.203.003	MXConsys Dongle and license (USB)	2	75
557.203.004	MXRemote Dongle and license (USB)	2	75
557.203.005	Set of spare keys for MX Panel (AL102)	2	79
557.203.021	MXLoop tester with EUROPEAN/UK MAINS to IEC CABLE	2	78
557.203.022	MX Loop Tester ECM Prog Null Modem	2	78
557.203.022	MX Loop Tester ECM Prog Null Modem	2	79
557.203.023	MX Loop Tester Carry Bag	2	78
557.203.023	MX Loop Tester Carry Bag	2	79
557.203.024	MX Loop Tester PSU	2	78
557.203.024	MX Loop Tester PSU	2	79
557.203.026	MX Loop Tester Battery Lead Set	2	78
557.203.026	MX Loop Tester Battery Lead Set	2	79
557.301.014	Spare Paper Roll (pk of 5)	2	24
557.800.057	DDM800 Detector Removal End of Line Resistor (pack of 10)	2	43
558.004.010	ELM 24V 4A Door Holder PSU	6	3
558.004.011	ELM24TSM 4 Amp 24VDC Addressable Door Holder PSU	2	48
558.004.020	24V 5Amp Power Supply Unit with housing for 17A/H Batteries	6	2
567.005.004	Relay 5010	6	4
567.007.008	Alarm Relay 240Vac MK4	6	4
567.007.009	Alarm Relay 24Vdc MK4	6	4
568.001.002	Relay 5010 PCB	6	4
568.001.018	MC600 Relay base	3	21
568.800.003	RIM800 relay interface module	2	44
568.800.004	HVR800 high voltage relay	2	44
568.800.033	RIM800 Module c/w Front Cover	2	44
568.800.034	HVR800 in isolated D800 housing	2	44
569.001.007	Cradle relay and retaining clip 2 C/O 26V 700 ohm coil 5 amp	6	4
576.501.001	YO3 Yodalarm sounder 3" 24Vdc 100dB @ 1Mtr	2	63
576.501.001	YO3 Yodalarm sounder 3" 24Vdc 100dB @ 1Mtr	3	35
576.501.002	YO5 Yodalarm sounder 5" 24Vdc 106dB @ 1Mtr	2	63
576.501.002	YO5 Yodalarm sounder 5" 24Vdc 106dB @ 1Mtr	3	35
576.501.003	YO8 Yodalarm sounder 8" 24Vdc 112dB @ 1Mtr	2	63
576.501.003	YO8 Yodalarm sounder 8" 24Vdc 112dB @ 1Mtr	3	35
576.501.012	Easy AV strobe for Banshee Sounders	2	70
576.501.012	Easy AV strobe for Banshee Sounders	3	43

Chapter 12 - Index

Product Code	Description	Chapter	Page
576.501.017	IS28 MARK 5 BANSHEE SOUNDER	10	9
576.501.017	IS28 MARK 5 BANSHEE SOUNDER	10	19
576.501.030	Squashni Squashni electronic sounder white 24Vdc	3	37
576.501.031	Blank cover plate white for Squashni electronic sounder	3	37
576.501.032.A	Flush Mount Bedroom Sounder ADT Branded	2	63
576.501.032.A	Flush Mount Bedroom Sounder ADT Branded	3	35
576.501.032.T	Flush Mount Bedroom Sounder Thorn Branded	2	63
576.501.032.T	Flush Mount Bedroom Sounder Thorn Branded	3	35
576.501.038	Besson wafer sounder and blank cover in white	2	63
576.501.038	Besson wafer sounder and blank cover in white	3	35
576.501.039.A	MBF-6EV ADT Branded Motorised Bell	2	60
576.501.039.A	MBF-6EV ADT Branded Motorised Bell	3	32
576.501.039.T	MBF-6EV Thorn Branded Motorised Bell	2	60
576.501.039.T	MBF-6EV Thorn Branded Motorised Bell	3	32
576.501.040.A	MBF-8EV ADT Branded Motorised Bell	2	60
576.501.040.A	MBF-8EV ADT Branded Motorised Bell	3	32
576.501.044.A	MBA-8EV ADT Branded Motorised Bell	2	60
576.501.044.A	MBA-8EV ADT Branded Motorised Bell	3	32
576.501.044.T	MBA-8EV Thorn Branded Motorised Bell	2	60
576.501.044.T	MBA-8EV Thorn Branded Motorised Bell	3	32
576.501.045	BBX4 (2) W/P Backbox for MBA-8 Bell	2	60
576.501.045	BBX4 (2) W/P Backbox for MBA-8 Bell	3	32
576.501.047	Banshee/Xenon bracket	2	63
576.501.047	Banshee/Xenon bracket	3	35
576.501.049	DB3 Flameproof Horn Sounder	10	21
576.501.052	Mini Fire-Cryer® Plus, voice enhanced base sndr cable spacing ring	2	69
576.501.052	Mini Fire-Cryer® Plus, voice enhanced base sndr cable spacing ring	3	42
576.501.060	Banshee Excel Sounder, red, IP45	2	62
576.501.060	Banshee Excel Sounder, red, IP45	3	34
576.501.061	Banshee Excel Sounder, white, IP45	2	62
576.501.061	Banshee Excel Sounder, white, IP45	3	34
576.501.062	Banshee Excel Sounder, red, IP66	2	62
576.501.062	Banshee Excel Sounder, red, IP66	3	34
576.501.063	Banshee Excel Lite, red sounder, red xenon beacon, IP45	2	62
576.501.063	Banshee Excel Lite, red sounder, red xenon beacon, IP45	3	34
576.501.131	Fire-Cryer® Plus, red wall mounted, shallow base, red beacon	2	69
576.501.131	Fire-Cryer® Plus, red wall mounted, shallow base, red beacon	3	42
576.501.132	Fire-Cryer® Plus, red wall mounted, deep base, red beacon	2	69
576.501.132	Fire-Cryer® Plus, red wall mounted, deep base, red beacon	3	42
576.501.133	Fire-Cryer® Plus, red, wall mounted, shallow base	2	69
576.501.133	Fire-Cryer® Plus, red, wall mounted, shallow base	3	42
576.501.134	Fire-Cryer® Plus, red, wall mounted, deep base	2	69
576.501.134	Fire-Cryer® Plus, red, wall mounted, deep base	3	42
576.501.135	Fire-Cryer® Plus (for use with Gas Extinguishant Systems)	2	69
576.501.135	Fire-Cryer® Plus (for use with Gas Extinguishant Systems)	3	42
576.501.141	Fire-Cryer® Plus, white wall mounted, shallow base, red beacon	2	69
576.501.141	Fire-Cryer® Plus, white wall mounted, shallow base, red beacon	3	42
576.501.142	Fire-Cryer® Plus, white, wall mounted, shallow base	2	69
576.501.142	Fire-Cryer® Plus, white, wall mounted, shallow base	3	42
576.501.151	Midi Fire-Cryer® Plus, c/w back box, red	2	69
576.501.151	Midi Fire-Cryer® Plus, c/w back box, red	3	42
576.501.161	Mini Fire-Cryer® Plus, base mounted, white, c/w cover	2	69
576.501.161	Mini Fire-Cryer® Plus, base mounted, white, c/w cover	3	42
576.501.171	Fire-Cryer® Plus Multi Message PCB	2	66
576.501.171	Fire-Cryer® Plus Multi Message PCB	2	69
576.501.171	Fire-Cryer® Plus Multi Message PCB	3	39
576.501.171	Fire-Cryer® Plus Multi Message PCB	3	42
576.501.172	Fire-Cryer® Plus Zone Extension PCB	2	66
576.501.172	Fire-Cryer® Plus Zone Extension PCB	2	69
576.501.172	Fire-Cryer® Plus Zone Extension PCB	3	39
576.501.172	Fire-Cryer® Plus Zone Extension PCB	3	42
576.501.173	Fire-Cryer® Plus Extinguishing PCB	2	66
576.501.173	Fire-Cryer® Plus Extinguishing PCB	2	69
576.501.173	Fire-Cryer® Plus Extinguishing PCB	3	39
576.501.173	Fire-Cryer® Plus Extinguishing PCB	3	42
576.501.181	Voice Message Controller c/w Multi Message PCB and 2.5A PSU	2	66
576.501.181	Voice Message Controller c/w Multi Message PCB and 2.5A PSU	2	69

Chapter 12 - Index

Product Code	Description	Chapter	Page
576.501.181	Voice Message Controller c/w Multi Message PCB and 2.5A PSU	3	39
576.501.181	Voice Message Controller c/w Multi Message PCB and 2.5A PSU	3	42
576.501.182	Voice Message Controller c/w Multi Message PCB and 5.25A PSU	2	66
576.501.182	Voice Message Controller c/w Multi Message PCB and 5.25A PSU	2	69
576.501.182	Voice Message Controller c/w Multi Message PCB and 5.25A PSU	3	39
576.501.182	Voice Message Controller c/w Multi Message PCB and 5.25A PSU	3	42
576.501.191	Fire-Cryer® Plus Demo Unit	2	69
576.501.191	Fire-Cryer® Plus Demo Unit	3	42
576.501.200	SY/R Low Power Red Symphoni Sounder (3 tone)	2	64
576.501.200	SY/R Low Power Red Symphoni Sounder (3 tone)	3	36
576.501.201	SY/W Low Power White Symphoni Sounder (3 tone)	2	64
576.501.201	SY/W Low Power White Symphoni Sounder (3 tone)	3	36
576.501.202	SYHO/R High Output Red Symphoni Sounder (32 tone)	2	64
576.501.202	SYHO/R High Output Red Symphoni Sounder (32 tone)	3	36
576.501.203	SYHO/W High Output White Symphoni Sounder (32 tone)	2	64
576.501.203	SYHO/W High Output White Symphoni Sounder (32 tone)	3	36
576.501.204	Symphoni 2 Wire Sounder (Red)	3	36
576.501.205	Symphoni 2 Wire Sounder (White)	3	36
576.501.220	ROSHNI Sounder c/w shallow base - RED	2	64
576.501.220	ROSHNI Sounder c/w shallow base - RED	3	36
576.501.221	ROSHNI Sounder c/w shallow base - WHITE	2	64
576.501.221	ROSHNI Sounder c/w shallow base - WHITE	3	36
576.501.222	ROSHNI/Flashni Deep Base - Red	2	64
576.501.222	ROSHNI/Flashni Deep Base - Red	3	36
576.501.223	ROSHNI/Flashni Deep Base - White	2	64
576.501.223	ROSHNI/Flashni Deep Base - White	3	36
576.501.224	Flashni complete with shallow base & tone switch	2	72
576.501.224	Flashni complete with shallow base & tone switch	3	45
576.501.227	Flashni c/w deep base, tone switch & separate sndr/strobe operation	2	72
576.501.227	Flashni c/w deep base, tone switch & separate sndr/strobe operation	3	45
576.501.230	Solista LED Beacon (Red)	2	70
576.501.230	Solista LED Beacon (Red)	3	43
576.501.232	Solex 10 cd Beacon with red lens and white base	3	44
576.501.242	Multi Tone Askari Compact bedroom sounder - white	3	37
576.501.243	Multi Tone Askari Compact bedroom sounder - red	3	37
576.501.250	Squashni G3/AV Sounder Beacon	2	72
576.501.250	Squashni G3/AV Sounder Beacon	3	46
576.501.251	Squashni G3/AV 2 Wire Sounder Beacon	3	47
576.501.255	Squashni G3/AV Blanking Cap – Pack of 5	2	72
576.501.255	Squashni G3/AV Blanking Cap – Pack of 5	3	46
576.501.255	Squashni G3/AV Blanking Cap – Pack of 5	3	47
576.501.401	MED W/P ROSHNI Sounder c/w deep base-red Marine approved	2	64
576.501.401	MED W/P ROSHNI Sounder c/w deep base-red Marine approved	3	36
576.501.402	MED ROSHNI Sounder c/w shallow base-red Marine approved	2	64
576.501.402	MED ROSHNI Sounder c/w shallow base-red Marine approved	3	36
576.501.403	MED Flashni complete with shallow base	2	72
576.501.403	MED Flashni complete with shallow base	3	45
576.501.405	MED 6" Red 24Vdc Motorised bell, "Fire" text with Thorn Branding	2	61
576.501.405	MED 6" Red 24Vdc Motorised bell, "Fire" text with Thorn Branding	3	33
576.501.407	MED 6" 24Vdc Electronic bell, weatherproof IP33C	2	61
576.501.407	MED 6" 24Vdc Electronic bell, weatherproof IP33C	3	33
576.501.408	MED 6" 24Vdc Electronic bell - red IP21C	2	61
576.501.408	MED 6" 24Vdc Electronic bell - red IP21C	3	33
577.001.023	SB520 Sounder Booster Module	2	44
577.001.033	SB520 Sounder Booster Module c/w Front Cover	2	44
577.001.035	601SB Conventional Sounder Base	3	21
577.001.036	602SB 2 Wire Line Powered Sounder Base	3	21
577.001.037	601SBD Conventional Diode Sounder Base	3	21
577.001.038	602SBD 2 Wire Line Powered Diode Sounder Base	3	21
577.002.002	MX Paging System Type A alarm pager	2	27
577.002.003	MX Paging System Type A maintenance pager	2	27
577.002.007	MX Paging System Pager aerial 60 db gain	2	27
577.002.008	MX Paging System Optional feeder cable (10m long)	2	27
577.025.032	DPS1200 Probe tube stainless steel 1200mm and exhaust	2	40
577.025.032	DPS1200 Probe tube Stainless Steel 1200mm and exhaust	3	23
577.800.005	SNM800 sounder notification module	2	44
577.800.006	DDM800 Universal Fire and Gas Module	2	43

Chapter 12 - Index

Product Code	Description	Chapter	Page
577.800.011	LPS800 Loop Powered Sounder module	2	44
577.800.035	SNM800 sounder notification module c/w Front cover	2	44
577.800.036	DDM800 Universal Fire and Gas Module c/w front cover	2	43
577.800.041	LPS800 Module c/w front cover	2	44
577.800.056	DDM800 Universal Fire and Gas Module housed in IP55 Enclosure	2	43
577.800.066	DDM800 Fire & Gas Detector Module in EExd Housing	10	13
577.800.067	MIM800 Input Module in EExd Housing	10	12
592.001.010	T110 PP9 Battery and Charger Kit	5	4
592.001.012	T110 Test Source	5	4
592.001.014	T210+ Adaptor required for the T210+	5	4
592.001.016	T210+ Test Source	5	4
592.001.018	T110 Adaptor for series 600 and 800 flame detectors	5	4
599.001.012	Lamp 28V 60mA used on T525	3	8
599.001.012	Lamp 28V 60mA used on T525	3	48
599.001.029	Spare bulb for E1/E3 24V-5W	3	8
599.001.029	Spare bulb for E1/E3 24V-5W	3	48
599.047.005	Address Labels 1 - 127 Loop E - Grey	2	39
599.047.006	Address Labels 1 - 127 Loop F - Blue	2	39
599.047.007	Address Labels 1 - 127 Loop G - Orange	2	39
599.047.008	Address Labels 1 - 127 Loop H - Red	2	39
599.047.011	Zone labels - Zones 1 - 16	2	39
599.047.012	Zone labels - Zones 17 - 32	2	39
599.047.013	Zone labels - Zones 33 - 48	2	39
599.047.014	Zone labels - Zones 49 - 64	2	39
599.047.015	Zone labels - Zones 65 - 80	2	39
599.047.016	Zone labels - Zones 81 - 100	2	39
599.047.018	Zone labels - Zones 101 - 120	2	39
599.047.019	Zone labels - Zones 121 - 140	2	39
599.047.020	Zone labels - Zones 141 - 160	2	39
599.047.021	Zone labels - Zones 161 - 180	2	39
599.047.022	Zone labels - Zones 181 - 200	2	39
599.047.023	Zone labels - Zones 201 - 220	2	39
599.047.024	Zone labels - Zones 221 - 240	2	39
599.047.030	Address Labels 1 - 250 Loop A - White	2	39
599.047.031	Address Labels 1 - 250 Loop B - Yellow	2	39
599.047.032	Address Labels 1 - 250 Loop C - Purple	2	39
599.047.033	Address Labels 1 - 250 Loop D - Green	2	39
599.048.001	DÄTWYLER Lifeline Fire Resistant P Clips 50 P34 Red	6	5
599.048.002	DÄTWYLER Lifeline Fire Resistant P Clips 50 P34 White	6	5
599.048.003	DÄTWYLER Lifeline Fire Resistant P Clips 50 P37 Red	6	5
599.048.005	DÄTWYLER Lifeline Fire Resistant P Clips 50 P40 Red	6	5
599.048.009	DÄTWYLER Lifeline Fire Resistant Glands 10 NG1 Red	6	5
599.048.010	DÄTWYLER Lifeline Fire Resistant Glands 10 NG1 White	6	5
599.048.020	DÄTWYLER Lifeline cable 2 + earth 1 mm Red	6	5
599.048.022	DÄTWYLER Lifeline cable 2 + earth 1.5 mm Red	6	5
599.048.023	DÄTWYLER Lifeline cable 2 + earth 1.5 mm White	6	5
599.048.024	DÄTWYLER Lifeline cable 2 + earth 2.5 mm Red	6	5
599.048.032	DÄTWYLER Lifeline cable 4 + earth 1 mm Red	6	5
599.048.034	DÄTWYLER Lifeline cable 4 + earth 1.5 mm Red	6	5
599.048.035	DÄTWYLER Lifeline cable 4 + earth 1.5 mm White	6	5
599.048.036	DÄTWYLER Lifeline cable 4 + earth 2.5 mm Red	6	5
609.001.015	24VDC double pole C/O relay 2K ohm coil, 2 Amps @ 30VDC	6	4
90-107	Red M141 spacer for red CP200/800 KAC callpoints	2	53
90-107	Red M141 spacer for red CP200/800 KAC callpoints	3	27
BAQ35T-24	MZX-c CONVENTIONAL PANEL POWER SUPPLY	3	48
CGUK-01	Consultants Guide	11	5
ECO-D-B-11	ECO Hydrogen H2 Gas Detector H2 0-100% LEL	7	12
ECO-D-B-12	ECO Methane CH4 Gas Detector 0-100% LEL	7	12
ECO-D-B-13	ECO Propane C3H8 Gas Detector 0-100% LEL	7	12
ECO-D-B-31	ECO Oxygen O2 Gas Detector 0-25% Vol	7	12
ECO-D-B-41	ECO Carbon Monoxide CO Gas Detector 0-500 PPM	7	12
ECO-D-B-41-45	ECO Dual Gas Detector Carbon Monoxide/Nitrogen Dioxide	7	12
ECO-D-B-42	ECO Amonia NH3 Gas Detecor 0-100 PPM	7	12
ECO-D-B-43	ECO Hydrogen Sulphide H2S Gas Detector 0-100 PPM	7	12
ECO-D-B-44	ECO Sulphur Dioxide SO2 Gas Detector 0-10 PPM	7	12
ECO-D-B-45	ECO Nitrogen Dioxide NO2 Gas Detector 0-10 PPM	7	12
ECO-SC-11	ECO Spare Cartridge Hydrogen H2 0-100% LEL	7	12

Chapter 12 - Index

Product Code	Description	Chapter	Page
ECO-SC-12	ECO Spare Cartridge Methane CH4 0-100% LEL	7	12
ECO-SC-13	ECO Spare Cartridge Propane CH8 0-100% LEL	7	12
ECO-SC-31	ECO Spare Cartridge Oxygen O2 0-25% Vol	7	12
ECO-SC-41	ECO Spare Cartridge Carbon Monoxide CO 0-500 PPM	7	12
ECO-SC-41-45	ECO Spare Cartridge Dual Carbon Monoxide/Nitrogen Dioxide	7	12
ECO-SC-42	ECO Spare Cartridge Ammonia NH3 0-100 PPM	7	12
ECO-SC-43	ECO Spare Cartridge Hydrogen Sulphide H2S 0-100 PPM	7	12
ECO-SC-44	ECO Spare Cartridge Sulphur Dioxide SO2 0-10 PPM	7	12
ECO-SC-45	ECO Spare Cartridge Nitrogen Dioxide NO2 0-10 PPM	7	12
G13801N-A	Elmdene 12V 1A PSU in Housing	2	27
OSE-HPW	OSID Emitter High Power, Wired	7	13
OSE-SP	OSID Emitter Standard Power	7	13
OSE-SPW	OSID Emitter Standard Power, Wired	7	13
OSI-10	OSID Imager 7o coverage	7	13
OSI-45	OSID Imager 38o coverage	7	13
OSI-90	OSID Imager 80o coverage	7	13
OSID-INST	OSID Installation Kit	7	13
PS-1212	12 Volt 1.2 Ampere hour rechargeable sealed lead acid battery	6	1
PS-12120	12 Volt 12.0 Ampere hour rechargeable sealed lead acid battery	6	1
PS-12170	12 Volt 17.0 Ampere hour rechargeable sealed lead acid battery	6	1
PS-1221	12 Volt 2.1 Ampere hour rechargeable sealed lead acid battery	6	1
PS-12260	12 Volt 26.0 Ampere hour rechargeable sealed lead acid battery	6	1
PS-1230	12 Volt 3.0 Ampere hour rechargeable sealed lead acid battery	6	1
PS-12380	12 Volt 38.0 Ampere hour rechargeable sealed lead acid battery	6	1
PS-1242	12 Volt 4.5 Ampere hour rechargeable sealed lead acid battery	6	1
PS-12650	12 Volt 65.0 Ampere hour rechargeable sealed lead acid battery	6	1
PS-1270	12 Volt 7.0 Ampere hour rechargeable sealed lead acid battery	6	1
PS-6100	6 Volt 10.0 Ampere hour rechargeable sealed lead acid battery	6	1
ROSHRDSR	ROSHNI Sounder c/w deep base - RED	2	64
ROSHRDSR	ROSHNI Sounder c/w deep base - RED	3	36
RU1-24	Relay Boxed 24Vdc Coil 5A contacts	6	4
TCD-1	MZX Interactive Training CD	2	74
UDS1100	Lantronics Device Server LAN	2	75
VKT-301	OSID Demo Kit	7	13

tyco *Fire Protection Products*

European Distribution Centre - Echt, Holland

(Warehousing / Distribution / Purchasing /
Customer Service / Call Centre Helpdesk)

Voltaweg 20

6101 XK

Echt

Holland

Tel: +31 475 371 666

Fax: +31 475 371 660

E-mail: tfseu.service@tycoint.com

European TSP Technical Support Call Centre

Toll Free: 0800 CALL TYCO or
(0800 22 55 89 26)

9:00 AM to 5:00 PM EET, CET & GMT

UK Only: 08701 238 787

UK Distribution Centre

(Warehousing / Distribution / Purchasing)

Dunhams Lane

Letchworth

Hertfordshire

SG6 1BE

United Kingdom

Tel: +44 (0) 1462 667 700

Fax: +44 (0) 1462 667 777

E-mail: tfsuk.service@tycoint.com

www.tycoemea.com

© 2013 Tyco Fire & Security PMCO01 Issue 8.2 / 01.13

The right is reserved to modify or withdraw any product or service without notice

a vital part of your world